



FIDESYS

strength analysis system

Version 5.1

User Guide





Introduction.....	6
About the Software.....	6
Getting Started.....	7
System Requirements.....	7
Hardware requirements.....	7
Operating system.....	7
Installation.....	7
Microsoft Windows.....	7
Linux.....	10
Activation and Trial Period.....	12
Trial period.....	12
Activation.....	12
Information on the Purchased License.....	13
Uninstalling the Software.....	13
The program Overview.....	14
Package Structure.....	14
Running the Software.....	14
Main Window.....	14
New Features in CAE Fidesys 5.1.....	16
Functional Additions and Improvements.....	16
Additions and Improvements to the Postprocessor.....	16
Additions and Improvements to the Postprocessor.....	16
Using the Program.....	17
Geometry.....	17
Geometry Import.....	17
Geometry Creating.....	18
Converter CDB.....	18
Meshing.....	19
Elements Type.....	19
Volume Meshing.....	20
Surface Mesh Generation.....	21
Parallel Meshing.....	21
Sculpt.....	21
Voxel Mesh.....	23
Setting Material.....	24
Set the Material.....	24



Setting tabular dependencies for materials	26
Import/Export Material.....	27
Setting the Yielding Model	28
Orthotropic Thermoelasticity	33
Blocks Operations	33
Setting Shell Properties	35
Multilayer Shells	36
Rotation of the Stress-Strain State of the Layer in the Element Coordinate System.....	37
Derivation of Stresses by Layers	37
Setting Beam Properties	39
Specifying Sphere Element Properties	40
Set Spring Properties	41
Local Coordinate Systems	42
Cylindrical Coordinate System.....	42
Spherical Coordinate System	43
Setting Boundary Conditions	44
Types of Boundary Conditions.....	44
Setting Initial Conditions.....	45
Types of Initial Conditions.....	45
Time/Coordinate Dependency.....	45
Setting Contact Interaction.....	48
Contact Region.....	48
Contact Types.....	50
Autoselection of Contact	50
Contact Algorithm.....	52
Elements Type.....	53
Contact Status.....	53
Bolt Pretension	54
Starting Calculation.....	56
Analysis Types	56
Mechanical Models	57
Multistep Solution	58
Setting Steps for Boundary Conditions	58
Setting Steps for Blocks (Volumes)	59
Spectral Element Method.....	61
SEM Brief Description and Advantages	61



SEM Usage.....	63
Heterogeneous Materials Effective Property Calculation	64
Geometry of the Model for Effective Property Calculation	64
Starting Calculation.....	65
Element Types	65
Effective Property Calculation and Its Results.....	66
SEG-Y Format.....	72
Spectral Method for Solving Linear Dynamic Problems Using the Response Spectrum (response spectrum, reaction spectrum).....	75
Modal Analysis.....	75
Response Spectrum Setting	75
Additive Printereng	76
Voxel Mesh and BCs.....	77
Starting Calculation.....	78
Results Visualization and Postprocessing	80
About Fidesys Viewer Software.....	80
Main Window	80
Basics of the Program.....	80
Overview of the strained model	81
Step-by-Step User Guide	88
Static Analysis (3D)	88
Static load (gravity force).....	107
Static load (beam model, reaction forces)	120
Static load (shell).....	131
Hydrostatic pressure on cylinder (setting boundary conditions according to coordinates).....	143
Buckling (shell model)	162
Modal analysis (3D).....	177
Modal analysis (shell model)	187
Setting heat transfer (3D, working with two blocks).....	196
Dynamic load: nonsteady heat transfer (3D, implicit scheme)	210
Harmonic analysis (beam model).....	221
Bounded Contact Simulation.....	238
The loading history of the elastic-plastic plate.....	250
Sequential addition of volumes in the calculation process.....	262
Sequential Deletion of Volumes in The Calculation Process.....	275
Seismic wave propagation (SEG-Y results).....	292



Poro-Elastic-Plastic Well Model (2D).....	306
Hertz problem for two hemispheres with contact.....	325
Calculation of the dynamic problem of plates with contact	347
Optimization Problem With Fidesys Python API	362
Contacts	383





Introduction

About the Software

CAE Fidesys is a software package for strength analysis. The package comprises the following types of analysis:

- Static loading
- dynamic (transient) loading
- buckling
- analysis of natural frequencies
- frequency analysis
- calculation of effective material properties
- response spectrum
- external integration MBD
- topological optimization.

The package also includes a program *Fidesys Viewer* for visualization and analysis of the obtained results:

- Visualization of scalar and vector fields
- SEG-Y files visualization
- building graphs and charts
- building frequency dependencies
- time dependency analysis.

Getting Started

System Requirements

CAE Fidesys has low system requirements for the package. It can be run on an ordinary personal computer. If the computer has one or more multi-core processors, calculations are automatically parallelized on all cores. Starting with version 1.5, calculation parallelization to several nodes connected to a local network or a cluster is available in the 64-bit version of the program package.

CAE Fidesys software package has following minimal requirements for software and hardware:

Hardware Requirements

- CPU: Dual-core 1,7 GHz minimum
- RAM: 4GB minimum
- Free hard drive space: 6 GB
- Video card NVIDIA GeForce GTX 460 or faster
- Screen resolution: 1024x768 or higher

Operating System

Following operating systems are supported. (for the 64-bit versions)

Windows 11	Ubuntu 16.04, Ubuntu 18.04, Ubuntu 20.04, Ubuntu 22.04
Windows Server 2022	Alt Linux 9.2
Windows 10	Debian 9, Debian 10, Debian 11
Windows Server 2019	RHEL 7, RHEL 8, RHEL 9
Windows Server 2016	Astra Linux Special Edition PYCB.10015-01
Windows 8.1	Astra Linux 1.6, Astra Linux 1.7
Windows 8	RedOS
Windows Server 2012	Centos 7, Centos 8, Centos 9
Windows Server 2012 R2	Oracle Linux Server 9
Windows 7 SP1	OpenSUSE 15.3, OpenSUSE 15.4
Windows Server 2008 R2 SP1	Rocky Linux 8.5
	Scientific Linux 7
	Fedora 36

NOTE: Install the latest updates for Windows.

Installation

Microsoft Windows

A user with administrator rights installs the software. Close all the *CAE Fidesys* windows before installation if there's another version of *CAE Fidesys* installed.

1. Download the *CAE Fidesys* installer from the site <http://www.cae-fidesys.com/ru/download/login> and run it for the architecture you are interested in (Windows x64 or Windows x32), or run the installation from the DVD-ROM.

If any other version of CAE Fidesys is already installed on a computer, after starting the installation program you will be asked to delete it or to cancel the installation.

2. Click **Next** in a pop-up window.

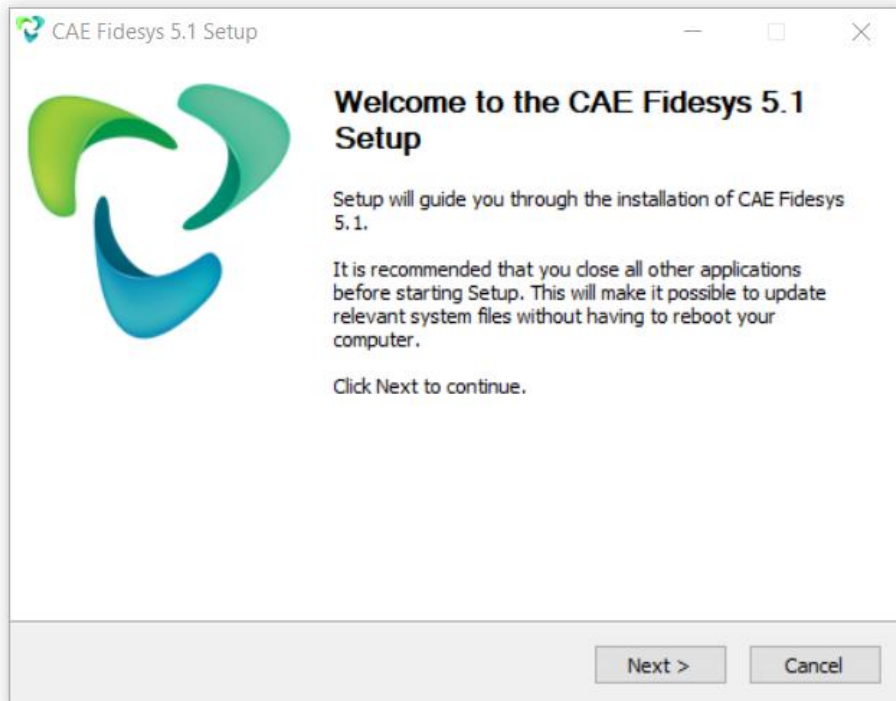

3. Read the license agreement. If you do not agree with any of its paragraphs, interrupt the installer by clicking **Cancel**. If you totally agree with its terms, click **Agree** to proceed the installation.



4. Select a folder for installation and click **Next**.

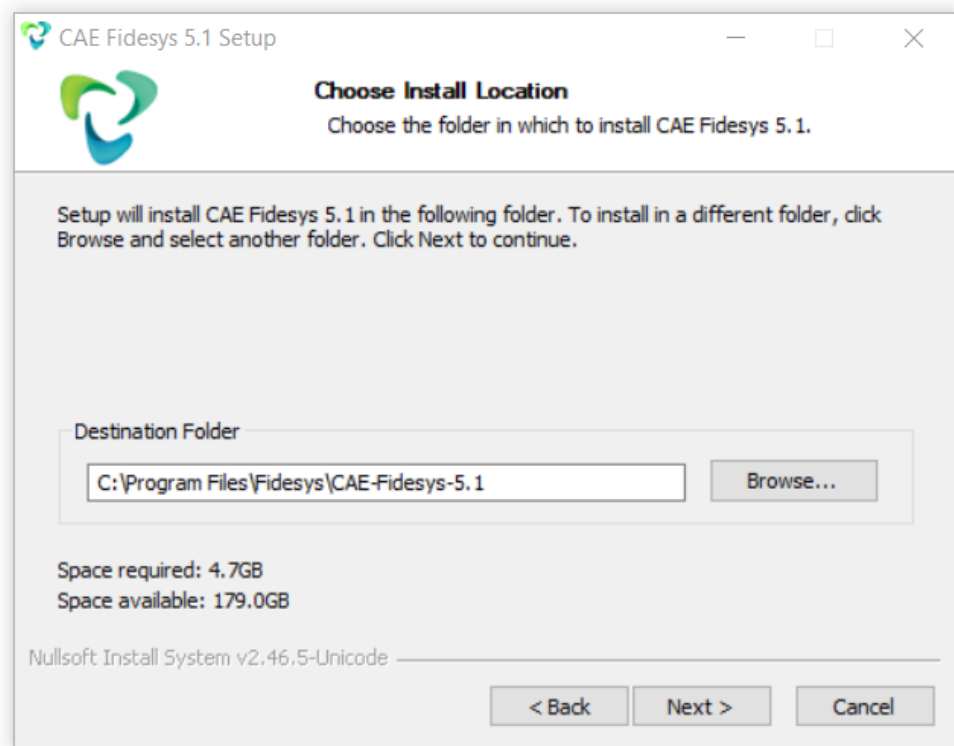

5. In the Start menu enter the name of the folder to create a shortcut for running the program. If you do not want to create a folder in the Start menu, choose **Do not create shortcuts**. Click **Install**.

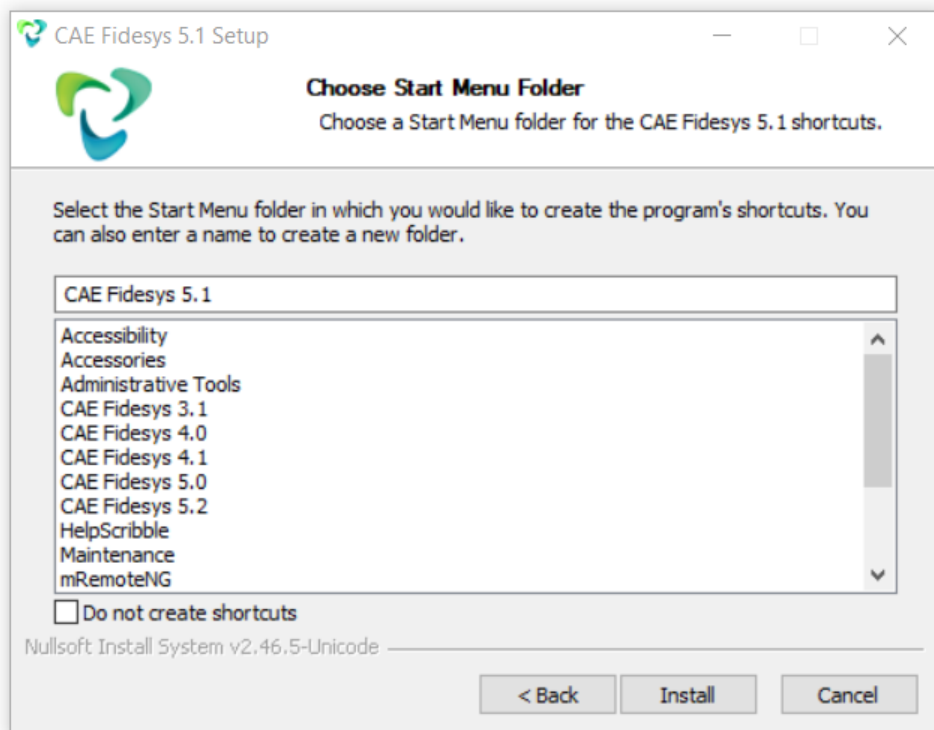

6. The process of installation may take some time. Click **Ready** after installing.

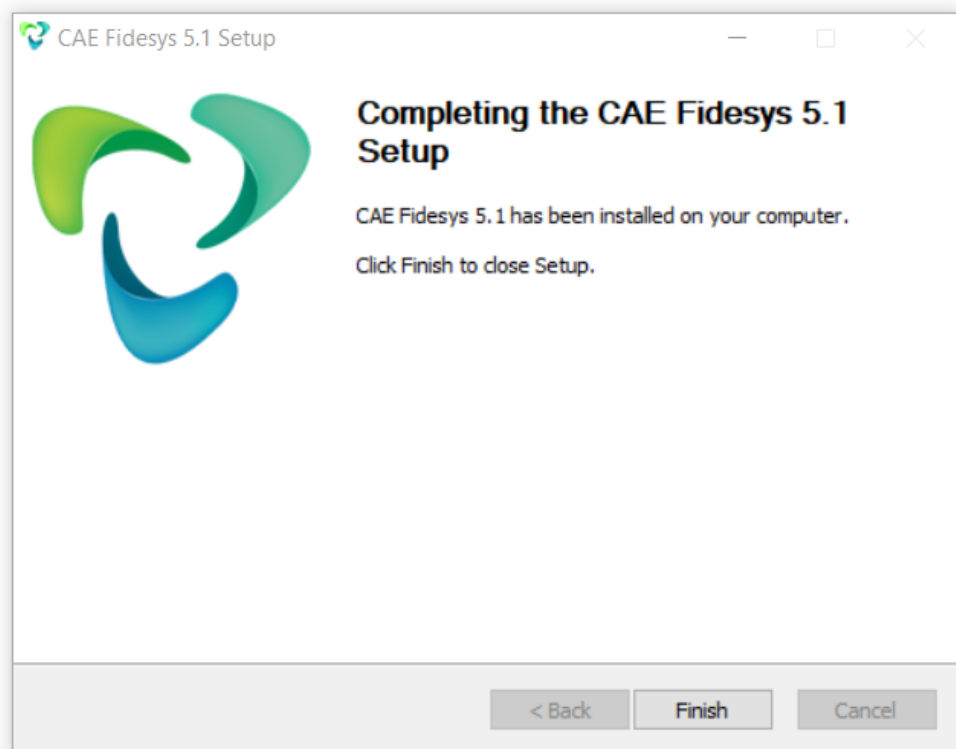

Linux

Only 64-bit Linux distribution kits are currently supported.

Setup file **CAE Fidesys** for Linux available for download only in the browser of the Linux operating system. Supported operating system: Ubuntu 20.04.

1. Download the **CAE Fidesys** file for Linux x64 from <https://www.cae-fidesys.com>.

2. Installer " CAE-Fidesys-5.1<version>-lin64-<language>-mpi.run ". Installation takes in two steps:

2.1. With user access rights in the terminal, a run file is launched to unpack the installer

```
./CAE-Fidesys-5.1.<version>-lin64-<language>-mpi.run
```

If the file is not executable, it must be designated as executable

```
chmod +x CAE-Fidesys-5.1.<version>-lin64-<language>-mpi.run
```

Default program installation directory is

```
./CAE-Fidesys-5.1
```

2.2. The installation script is launched as administrator

```
sudo <path_to_install_directory>/install.sh
```

2.3. To uninstall the program, run the script as administrator

```
sudo <path_to_install_directory>/uninstall.sh
```

3. Second installer option " CAE-Fidesys-5.1-<language>-mpi_<version>_amd64.deb". Installation takes in 1 step:

3.1. Run as administrator

```
sudo dpkg -i CAE-Fidesys-5.1-<language>-mpi_<version>_amd64.deb
```

Default program installation directory is



/opt/fidesys/CAE-Fidesys-5.1

3.2. To uninstall the program, run the script as administrator

```
sudo dpkg -r CAE-Fidesys-5.1
```

4. Start the program

4.1. **CAE Fidesys**. In console/terminal

```
cae-fidesys-5.1
```

4.2. **Fidesys Viewer**. In console/terminal

```
fidesys-viewer-5.1
```

Activation and Trial Period

When you first run the preprocessor, the *Fidesys Licensing* window appears with a proposal to purchase a license or to activate a trial period.

Trial Period

30-day trial period is automatically activated during installation. The trial period starts at the moment when application installation is completed. The trial period is for familiarization with the product and is not for any commercial calculations (related directly or indirectly to getting a profit out of them). The trial period can not be activated on a virtual machine, and the trial version is not designed to work through remote desktop.

To activate a trial period, click the button **Trial period** in the start window.

As long as the program runs in trial mode, the *Fidesys Licensing* window appears each time you launch it. Click **Try** to continue working in a trial mode.

Activation

To activate the product:

1. Click **Activate** in the *Fidesys Licensing* window.
2. Select **I do not have a V2C file** and click **Generate C2V**. The system opens the Save file window. Save the C2V file and send it to the organization where the product was purchased.
3. In response, you get a file containing an activation key with V2C extension. After receiving the V2C file, select **I have V2C file** and click **Apply V2C**. An Open File dialog window appears on the screen. Indicate in it the path to the received file.

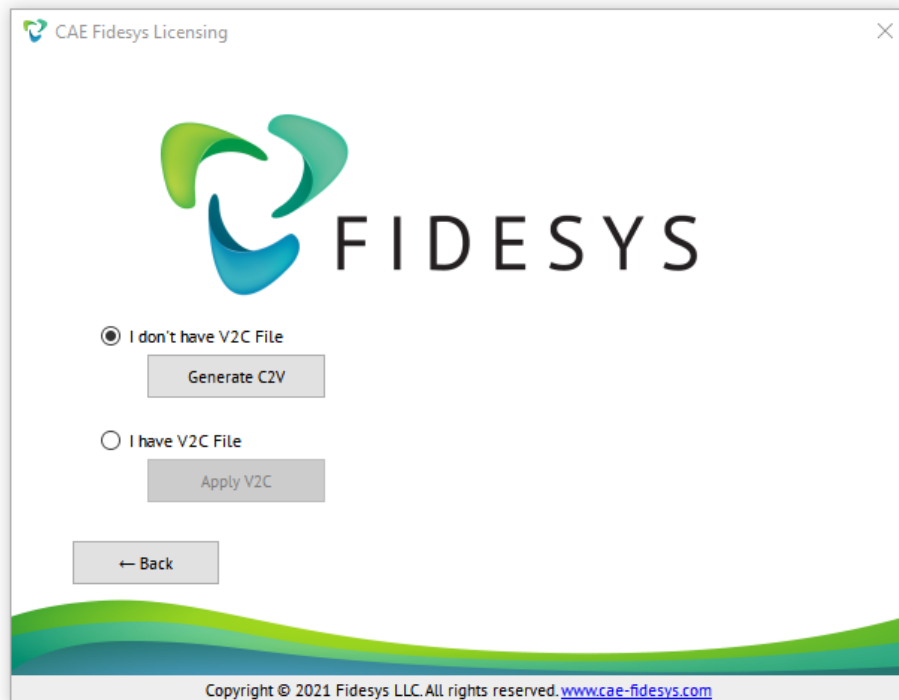

4. Your product is activated.

The system will accomplish the activation automatically when using a dongle.

Information on the Purchased License

Select **Help** → **About** in the Main Menu, and you see a window with the following information:

- Full software version number;
- License type and its expiration date;
- The list of features available in the purchased license.

Uninstalling the Software

A user with administrator rights uninstalls the software.

Close all the running copies of the application before uninstalling the software: both preprocessor (*Fidesys*) and postprocessor (*Fidesys Viewer*).

To remove the software, open Windows Control Panel and select **Programs and Features** (**Add or Remove Programs** in the earlier versions of Windows). Select *CAE Fidesys* *###.# xNN* in the list of installed programs, where *###.#* are four numbers standing for the number of the version and *xNN* is the architecture (x64). Right-click it and choose **Delete/Change**. Confirm your choice by clicking **Delete** in the opened window.

Removing the software does not involve removing its activation data.

The program Overview.

Package Structure

CAE Fidesys comprises three main components:

- **Fidesys** — preprocessing and analysis (computational kernels).
- **FidesysCalc** – calculations;
- **Fidesys Viewer** — postprocessing and visualization of results.

Running the Software

You can run the program in either of the following ways:

- Use the Start menu (if you chose creating shortcuts in it when installing): choose **Fidesys** in the folder where you installed the program.
- Use any file manager for Windows from the list where the program was installed (C:\Program Files\Fidesys\Fidesys 4.0 by default): run the file **fidesys.exe** (it is in the folder **preprocessor\bin**).

Several copies of the program can be run on the same PC at a time.

If you work on the licensed version, after running the program you see its Main window. If you use the trial period, a **Fidesys Licensing** window appears in which you should either click **Activate** in order to purchase a license or click **Try** to continue working in trial mode and go to the Main window.

Main Window

CAE Fidesys has an intuitive graphic interface providing communication between the user and the software, and it allows the user to perform the full cycle of calculations step-by-step.

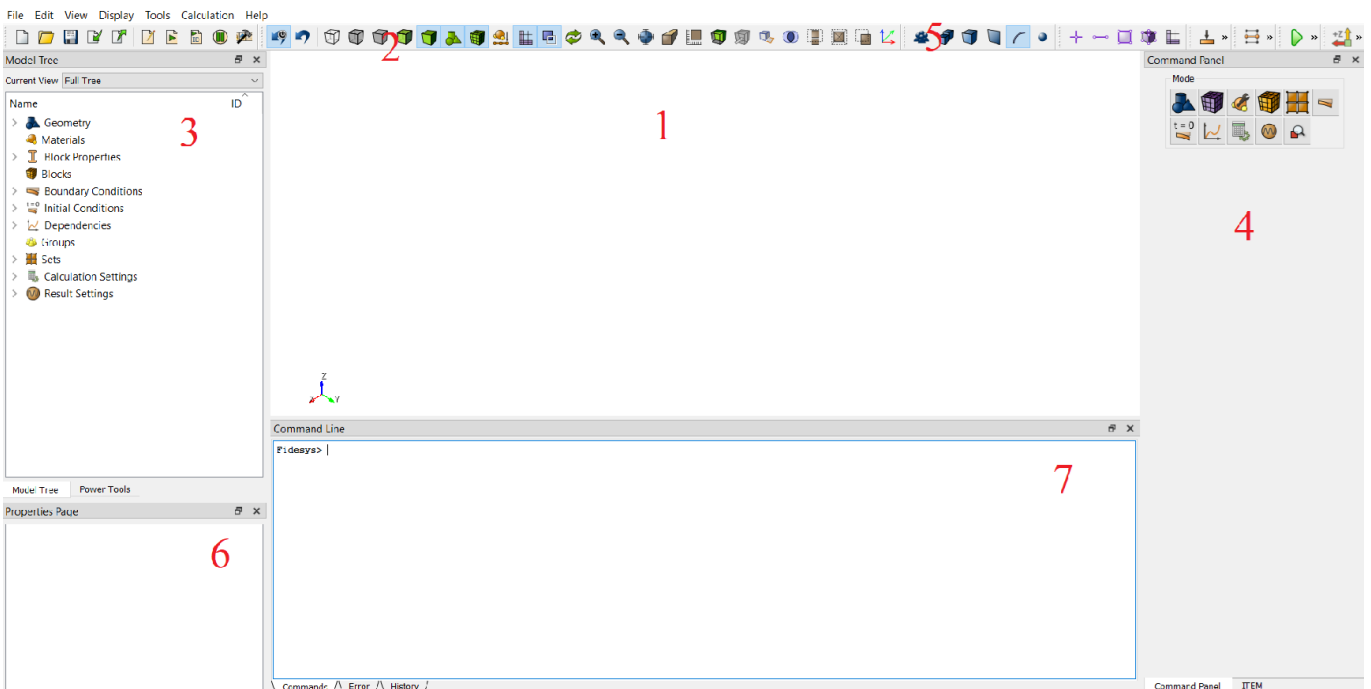

Workbench (1) displays the model and visual effects.



Main Menu (2) includes standard operations for working with files and projects, managing the visualization modes, panel display settings, help, and other functionality available in the drop-down lists of the menu.

Power Tools (3) comprise the Model Tree, as well as the tools for geometry and mesh analysis.

Command Panel (4) contains most of commands for working with the program. Panel display buttons are logically located, and it allows the user to perform the full cycle of calculations step-by-step.

Toolbar (5) comprises the buttons for calling the most frequently used commands while working with the program.

Properties Page (6) displays the properties of the selected object in the Workbench or in the Model Tree.

Console (7) helps you to input the *CAE Fidesys* commands and to display the messages to the user.

New Features in CAE Fidesys 5.1

Released: december 2022

Functional Additions and Improvements

- Added common contact with friction for FEM and SEM
- Supported order for the SEM - 9
- Added step-by-step loading with a change in the topology (composition of blocks) of the body, taking into account finite deformations
- Added elastic-plastic calculation for the Drucker-Prager model with tabular (multilinear isotropic) asymmetric hardening for small deformations
- Added calculation of poroelastic effective properties
- Added integration with BricsCAD and NanoCad packages
- Added linear isotropic hardening type 1 for the von Mises plasticity model
- Added calculation of thermal conductivity for orthotropic laminate shells
- Added calculation for orthotropic thermoelasticity
- Added the ability for material properties to set dependence on temperature
- Added the ability to calculate random vibration
- Added specification of cylindrical and spherical coordinate systems (preprocessor)
- Added ability to calculate materials with zero density for modal analysis
- Fixed display of results in the 3D view of beams for high SEM orders
- Improved and extended *.cdb file convert

Additions and Improvements to the Postprocessor

- Changed the interface for calculating Additive Printing
- Added display of local coordinate systems for beam and shell elements

Additions and Improvements to the Postprocessor

- Residual response added for linear spectral analysis
- Improved "Harmonic Analysis" filter: interactive node selection implemented, reaction calculation added
- Added new filter "Multi-threshold"
- Expanded functionality of the filter "Coordinate systems"
- Improved filter "Margin of safety"
- Time or harmonic index display added to model display area

Using the Program

Performing calculations with the use of *CAE Fidesys* implies the following steps:

- Setting the geometry;
- Meshing;
- Setting boundary conditions;
- Setting the material;
- Starting calculation;
- Visualizing and analyzing results.

All of the steps except for the last one are accomplished in preprocessor; the last step is accomplished in postprocessor.

Geometry

CAE Fidesys allows to generate volume geometry on your own due to the built-in functionality, as well as to import 3D models created in different CAD-systems.

Geometry Import

For geometry import choose **File** → **Import** in the Main menu. *CAE Fidesys* supports the import of the following formats:

- ACIS (*.sat, *.sab);
- IGES (*.igs, *.iges);
- STEP (*.stp, *.step);
- Warefront Object (*.obj);
- Stanford Polygon (*.ply);
- GAMBIT Real Geometry (*.dbs);
- Catia (*.CATPart, *.CATProduct, *.ncgm);
- Parasolid (*.x_t, *.x_b);
- SolidWorks (*.sldprt, *.sldasm);
- JT (*.jt);
- Pro/E (*.ptr, *.asm);
- Exodus (*.e*, *.exo);
- Genesis (*.g, *.gen);
- Abaqus (*.inp);
- STL Files (*.stl);
- Facets (*.fac);
- Fluent (*.msh);
- AzoreCFD (*.azmsh);
- GAMBIT Neutral (*.neu);
- I-DEAS (*.unv);
- Nastran (*.bdf);
- Patran (*.pat, *.neu, *.out);
- Cubit files (*.cub);
- Cubit HDF5 (*.cub5, *.trellis);
- CATIA v4 (*.model);
- Ansys Mesh Files (*.cdb);
- Fidesys Project (*.fds);
- Fidesys Case (*.fc);
- VTK UnstructuredGrid (*.vtu);
- FidesysViewer Data Files (*.pvd);
- Additive Manufacturing (*.cli).

Geometry Creating

For geometry generation *CAE Fidesys* provides the user with large numbers of volume geometric primitives (parallelepiped, cylinder, prism, cone, pyramid, sphere, torus). It also allows uniting the surfaces in closed volume bodies. For complex geometry generation you can use Boolean operations (Intersect, Subtract, Unite volumes) and different transformations of the object (Rotate, Move, Scale, Reflect). All of the described functionality is available on Command Panel in **Geometry** section.

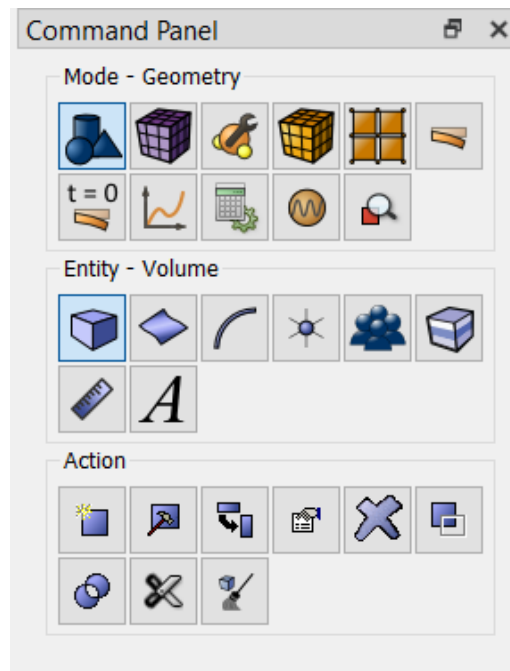

Converter CDB

In CAE Fidesys, it was possible to import a cdb file. The cdb format is an archive format supported by the Ansys software package.

These files contain the following information about the model: finite element mesh, material, boundary conditions, analysis type, calculation parameters.

Below is information about the capabilities of the cdb envelope in the CAE Fidesys software package.

Table 1 - Conversion of types of analysis

Analysis	Analysis (Ansys)	Result
Static	Antype,Static	Static
Mode Frequency Analysis	Antype,Modal	Analysis of frequencies, waveforms
Buckling	Antype,Buck	Calculation for buckling

Table 2 - Conversion of finite element types

Element	Element (Ansys)	Result
Solid	solid186, solid187	Solid (1 or 2 order)
Shell	shell181,shell281	Shell (1 or 2 order)
Beam	beam188,beam189	Beam (1 or 2 order)
Linear spring	combin14	Spring (type - linear)
Combination spring	combin40	Spring (type - combination)
Discrete mass element	mass21	LumpMass

Table 3 - Conversion of boundary conditions

BC	APDL script	Result
Displacement	D;DK;DL;DA	Displacement (entities - nodes)
Node Force, Moment	F	Force (entities - nodes)
Binding degrees of freedom	COUPLING	Coupling Constraint (variables)
Bonded region	CERIG	Coupling Constraint (distance between entities)

Table 4 - Conversion of the physical properties of the material

Properties	Properties (Ansys)	Result
Linear elastic isotropic material (Young's modulus, Poisson's ratio)	Linear Isotropic Material Properties (EX,PRXY)	Hooke's material (Young's modulus, Poisson's ratio)
Mass density	Density	Density
Thermal expansion coefficient	Isotropic thermal Secant Coefficient	Thermal expansion coefficient

Fidesys 5.1 introduced the ability to convert the surface load from the Ansys package. The result of this conversion will be the "Distributed force" field, located in the "Loads" tab.

Meshing

Elements Type

CAE Fidesys supports the following types of the finite elements for meshes:

- volume: SOLID (tetrahedrons, hexahedra, pyramids, prisms);
- plane: PLANE (triangles, quadrangles);
- shell: SHELL (triangles, quadrangles);

- beam: BEAM;
- springs: SPRING;
- point masses: LUMPMASS.

The order of all elements, except for springs and point masses, can vary from 1st to 9th. The order of the element above the second means using the method of spectral elements.

Volume Meshing

Select volume mesh generation section on Command Panel (Mode — **Mesh**, Entity — **Volume**).

1. Specify the degree of mesh refinement (Action — **Intervals**) for each volume:
 - Select the volumes (specify their ID). You can enumerate several volumes using space after each of them. All of the volumes can be set by the command **all**;
 - Select the way of mesh generation (Auto, Approximate size, Geometry-adaptive, Interval or Sizing function) ;
 - Click **Apply Size**.
2. Specify the type of the elements for each volume:
 - Select the entities for mesh generation (specify their ID). You can enumerate several volumes using space after each of them. All of the volumes can be set by the command **all**;
 - Select meshing scheme (tetrahedral (Tetmesh) or hexahedral elements (Automatically calculate));
 - For tetrahedral mesh generation select the level of optimization (Extreme, Strong, Heavy, Standard, Medium, Light, or None) and set the checkboxes in front of the corresponding points, if you need to minimize the over-constrained and/or sliver tets.
 - Click **Apply Size**;
 - Click **Mesh**.

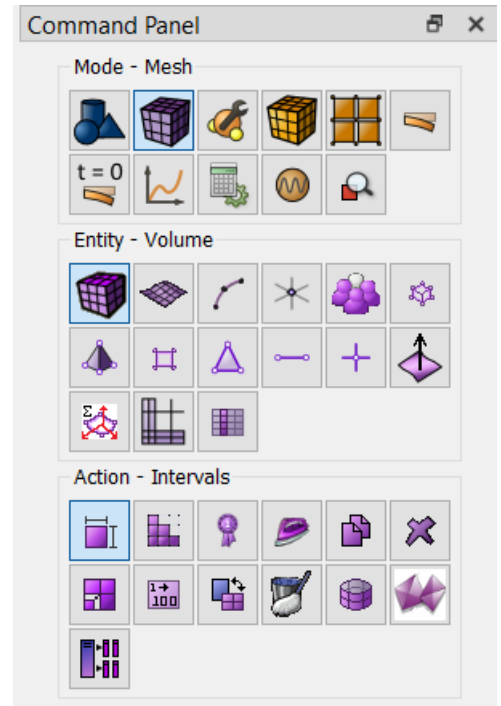

For complex geometry it is recommended to set the scheme of surface mesh generation first (triangular or quadrangular elements).

Surface Mesh Generation

To generate a surface mesh, follow these steps.

1. Select surface mesh generation section on Command Panel (Mode — **Mesh**, Entity — **Surface**).
2. Specify the degree of mesh reducing (**Action - Intervals** – **Approximate size**) of each surface:
 - select volumes (specify their ID). Multiple volumes can be listed through a space; all volumes can be specified using the command **all**;
 - indicate the **Approximate size**;
 - Click **Apply Size**.

To generate an irregular mesh (e.g. make it finer in the vicinity of stress concentrators), you can add nodes on the boundaries near geometry features, as well as split curves, surfaces and volumes in the vicinity of the features.

Using the functionality available on Command Panel you can:

- Check the mesh quality (including checking the mesh quality of individual elements: volumes, surfaces, curves);
- Modify the generated mesh (Refine, Smooth, Delete);
- Renumber the elements and delete the generated mesh.

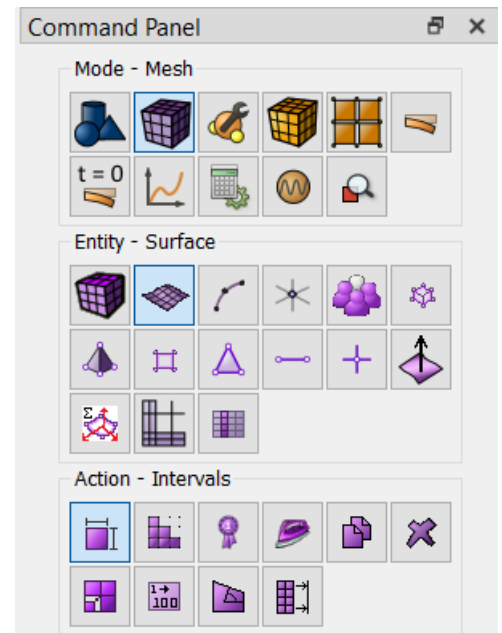

Parallel Meshing

Fidesys has been designed as a serial application, using a single CPU to generate its meshes. In some cases, where memory or time constraints are critical, parallel meshing may be necessary. Fidesys currently provides a separate application designed to run in parallel either on a desktop or on massively parallel cluster machines. In these cases, Fidesys can be used as a pre-processor to manipulate geometry and set up for meshing, however the actual meshing procedure is performed as a separate process or on another machine.

Sculpt

Sculpt is a separate parallel application designed to generate all-hex meshes on complex geometries with little or no user interaction. Fidesys provides a front end command line and GUI for the Sculpt application. The command will build the appropriate input files based on the current geometry and can also automatically invoke Sculpt to generate the mesh and bring the mesh back to Fidesys.

Sculpt parameters are divided into 4 areas: Size, Mesh, Smoothing, and Parallel.

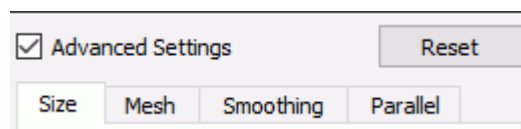

The method for generating an all-hex mesh employed by Sculpt is often referred to in the literature as an *overlay-grid* or *mesh-first* method. This differs significantly from the algorithms employed by Sweeping and Mapping, which are classified as *geometry-first* methods. Mapping and Sweeping start with the geometry, carefully fitting logical groupings of hexes to conform to a recognized topology. In contrast, the Sculpt method begins with a base Cartesian grid encompassing the geometry which is used as the basis for the mesh. Geometric features are carved or sculpted from the Cartesian grid and boundaries smoothed to create the final hex mesh. The obvious benefit of the Sculpt (*mesh-first*) method over Mapping and Sweeping (*geometry-first*) methods is there is no need to decompose the geometry into mappable or sweepable components, a process that can often be very time consuming, tedious and sometimes impossible. Input to Sculpt can be any geometry regardless of features and complexity.

The basic Sculpt procedure is illustrated in figure 1. Beginning with a Cartesian grid as the base mesh, shown in figure 1(a), a geometric description is imposed. Nodes from the base grid that are near the boundaries are projected to the geometry, locally distorting the nearby hex cells (figure 1(b)). A pillow layer of hexes is then inserted at the surfaces by duplicating the interface nodes on either side of the boundaries and inserting hexes (figures 1(c) and (d)). While constraining node locations to remain on the interfaces, smoothing procedures can now be employed to improve mesh quality of nearby hexes (figure 1(e)).

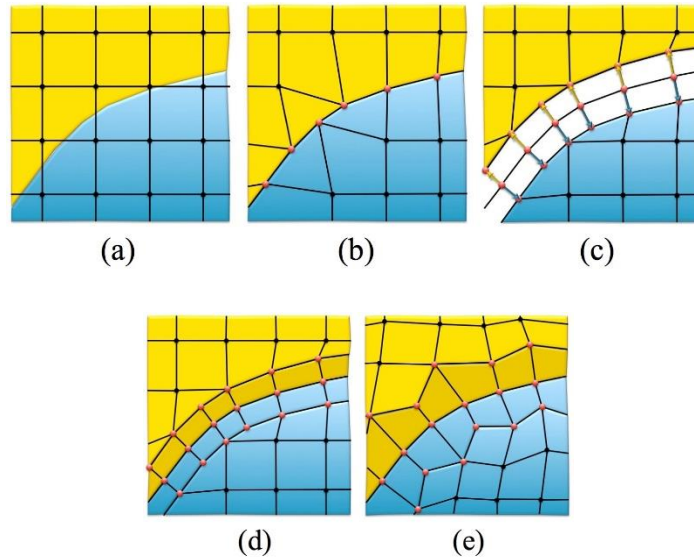
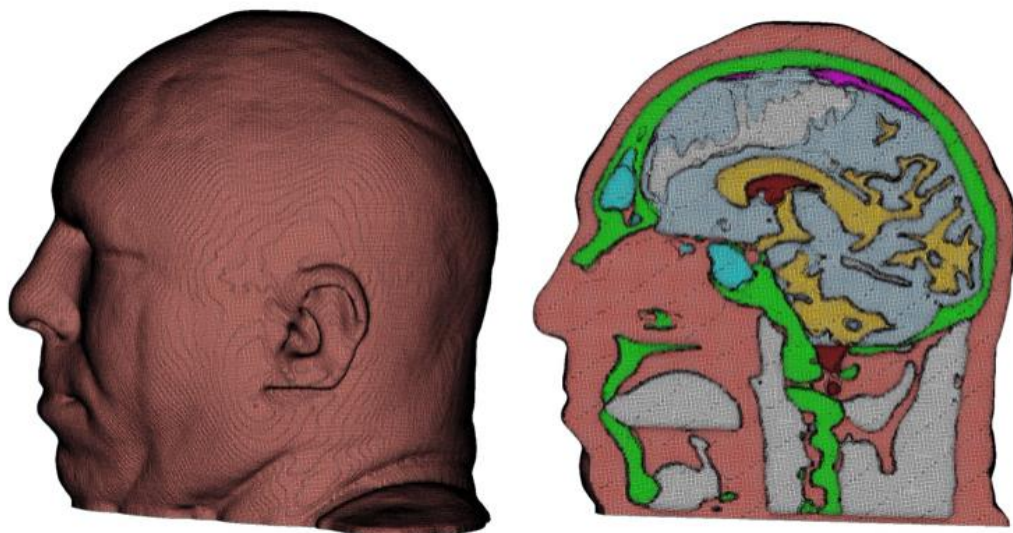

Figure 1. The procedure for generating a hex mesh using the Sculpt overlay grid method

New meshing capabilities let you cut out the overlay mesh using the STL geometry definition. This is useful when the block definition in the source mesh does not exactly match the STL geometry. Also, a new `calculate_ss_stats` option will report the surface area statistics of the resulting side parts in the original mesh. This is often useful for microstructures where it is important to know the interface area between materials.



New options for creating a hexahedral mesh using the Sculpt method

Voxel Mesh

Applies to: Volumes.

Summary: A voxel mesh will be create for a volume.

Settings: Command Panel, Mode - Mesh, Entity - Volume, Action - Mesh, Voxel.

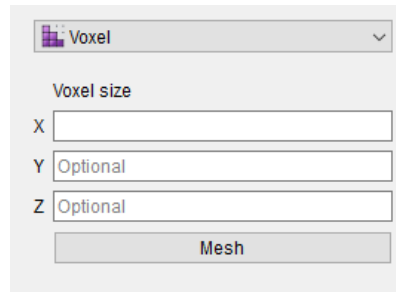

Syntax:

```
voxelmesh x [y ] [z ] [use_api]
```

Where

- x, y, z - voxel sizes;
- use_api - a parameter indicating the use of api during grid generation (set by default).
- When constructing a voxel mesh, a block is created for each layer, to which a material must be assigned in the future.

Discussion: The word voxel is derived from the word VOLume and the abbreviation piXEL (pixel stands for PICTURE'S ELEMENT, image element). That is, it is translated as “element of the volumetric image” or “element of the volume of the image”. A voxel is an element of a three-dimensional image. An analogue of a hexagonal mesh.

Voxel mesh examples

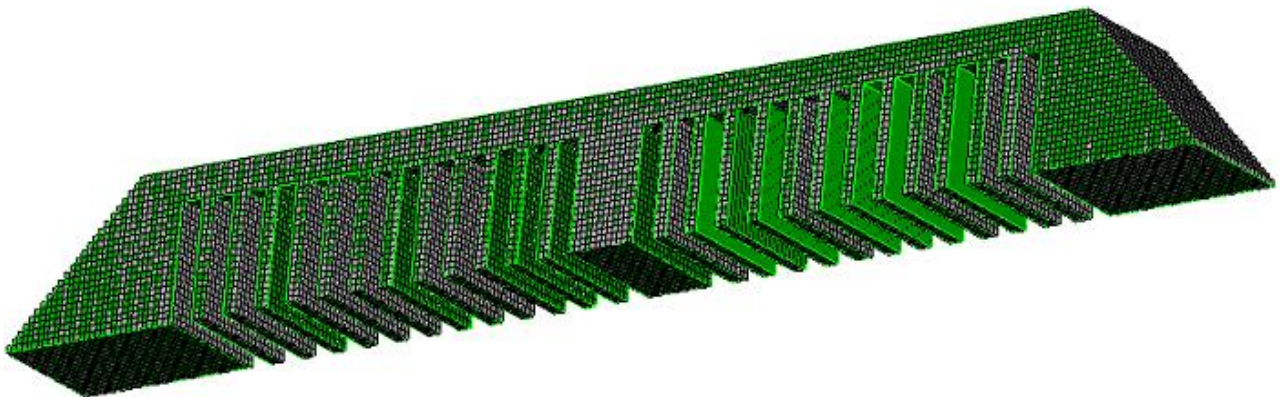

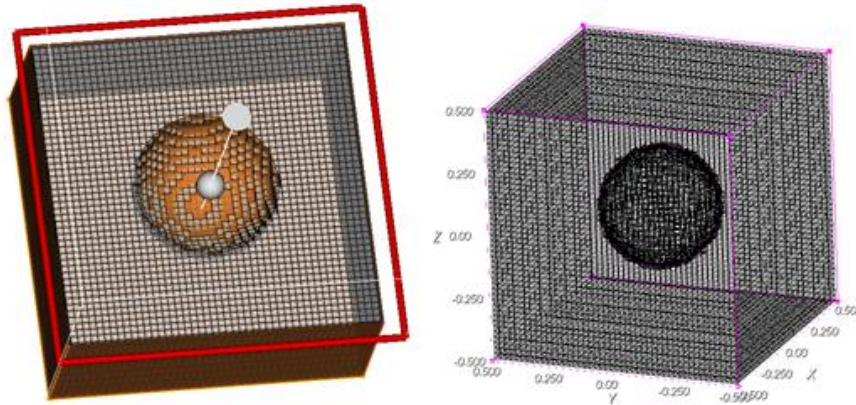

Setting Material

Set the Material

CAE Fidesys supports the following materials:

- Hooke material;
- Orthotropic material;
- Transversely isotropic material;
- Mooney Rivlin material;
- Material Blatza-Ko;
- Murnaghan material;
- Elastoplastic material (Mises criterion, Drucker-Prager);
- Thermoelastic material;
- Poroelastic material (Bio Model).

For Mooney-Rivlin and Murnaghan materials, the following defining relations are used.

Mooney-Rivlin potential:

$$W = C_1(\bar{I}_1 - 3) + C_2(\bar{I}_2 - 3) - D(J - 1)^2,$$

where D , C_1 , C_2 are Mooney-Rivlin material constants.

Relation of D , C_1 , C_2 and Poisson's ratio ν :

$$D = \frac{C_1 + C_2}{1 - 2\nu}.$$

Murnaghan potential:

$$\Sigma_{0,n}^0 = \lambda(\varepsilon \cdot I)I + 2G\varepsilon + 3C_3(\varepsilon \cdot I)^2I + C_4(\varepsilon \cdot I)I + 2C_4(\varepsilon \cdot I)\varepsilon + 3C_5\varepsilon^2$$

where λ , G , C_3 , C_4 , C_5 are Murnaghan material constants.

To set the new material, select the setting material properties section on Command Panel (Mode –**Materials**, Entity – **Materials Management**).

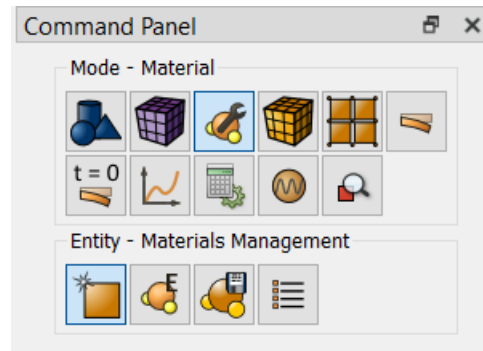

Material properties are set in the Materials Management widget.

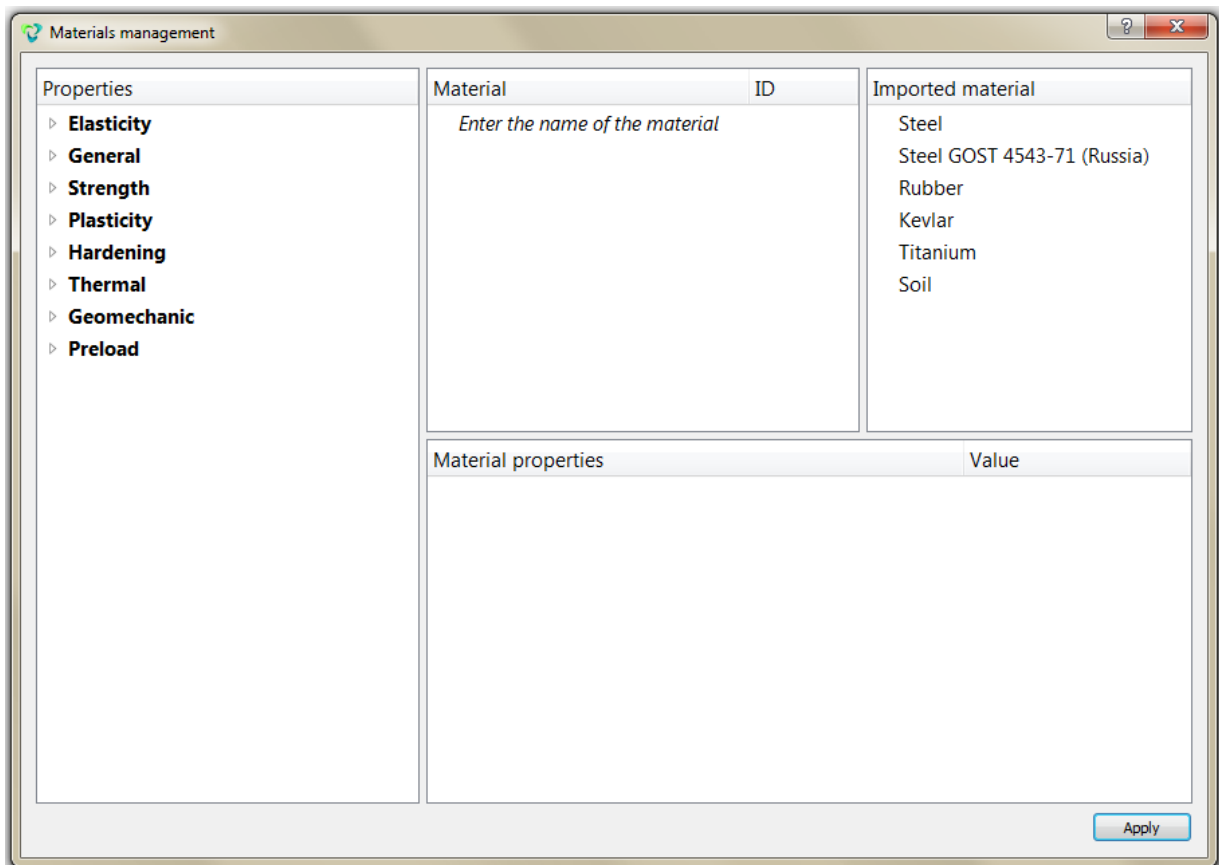

Next, using the “drag & drop” method, add the necessary characteristics from the left column to the Material Properties column.

Select the desired characteristic with the mouse. Hold down the left mouse button and drag the label to Material Properties. Double-click in the Value field opposite the property that appears and specify the correct value.

The right column shows the preset materials. To use these materials in the calculation also drag the material of interest into the Materials column (where the active materials are located). Click the **Apply** button.

Upon successful addition, the created materials should appear in the Model Tree in the Materials section.

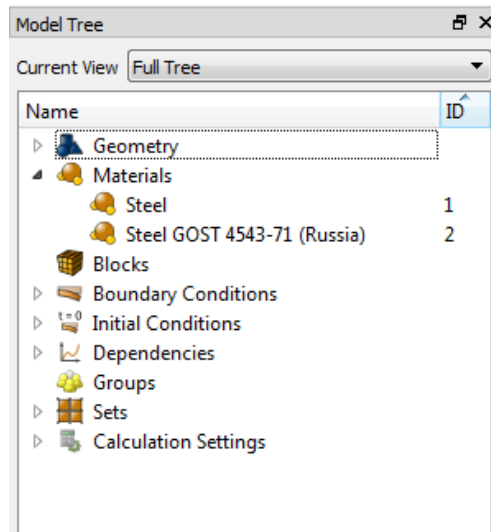

Note: Use **Block** to link the material and the model.

Setting tabular dependencies for materials

To create tabular dependencies for material characteristics, double-click in the Value field opposite the desired property. A button with a triple point will appear. Click this button. The **Edit Table** widget opens, where you can set table dependencies.

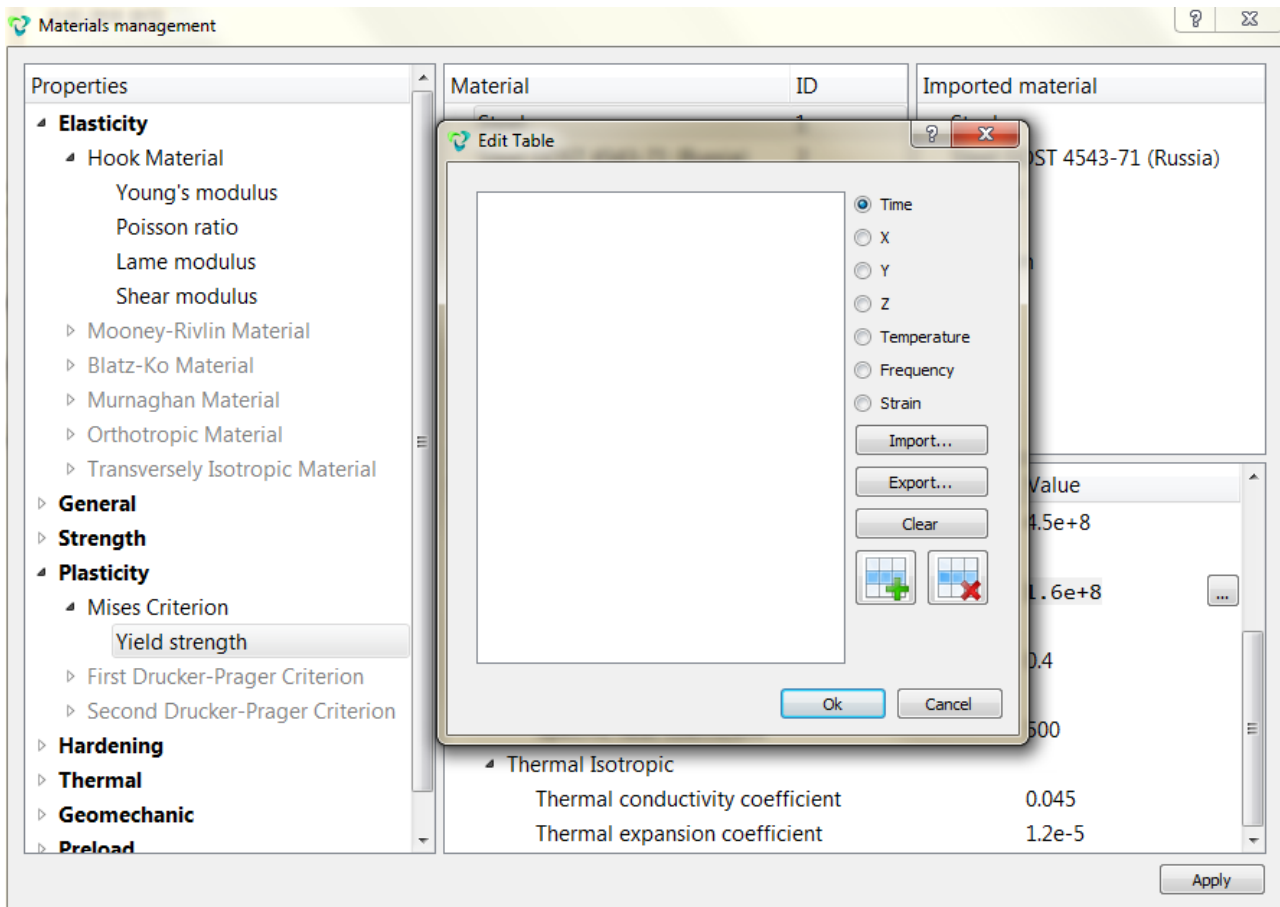

To specify a formula dependence, enter the appropriate formula in the Value field and then click **Apply**.

Material properties	Value
▼ Hook Material	
Young's modulus	200*t
Poisson ratio	0.3521
▼ Second Drucker-Prager Criterion	
Cohesion	1.505e+7
Internal friction angle	31.1066
Dilatancy angle	31.1066
▼ Thermal Isotropic	
Thermal conductivity coefficient	8e-6

Import/Export Material

To import materials right-click in the Imported Material column. Select Import in the context menu. Specify the path to the imported material.

Panel settings for an existing material change, if an added material with the same name already exists in previously imported materials:

- If it is allowed to overwrite it, tick the Overwrite checkbox.
- If you need to add a new one, put the Append checkbox, and the material will be added with renaming.
- By default, the check is set to Ignore - the material is not imported, the previous material remains.

Click **Apply**. Next, drag the imported material into the active materials column (Material). Click **Apply**.

CAE Fidesys supports importing material in XML format.

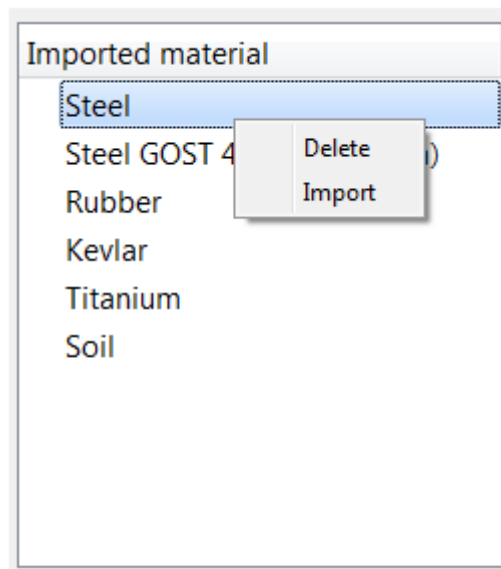

To export the created material, right-click the material name, select Export in the context menu. Specify the path to save the file, click **Apply**.

Material	ID
Steel	1
Steel GOST 4543-71 (Russia)	2

Enter the name of the material

- Delete
- Export

If the value of a property is not entered, then by default it is assumed to be zero (except for the shear modulus, which is determined automatically based on the entered values of E and ν).

Setting the Yielding Model

The choice of the correct model of the material plastic flux is very important to obtain a proper solution of the problem. Plasticity problems are nonlinear, therefore, they require substantial computer resources and solving problems with large plastic strains may take a long time. The Fidesys system of strength analysis for the Hook material realizes two criteria of transition into plasticity: the Mises criterion and the Drucker-Prager criterion. Problems are solved both for perfectly elastoplastic models and for models with linear hardening. An approach taking into account finite strains in the elastic zone is currently implemented; the linear formulation of the problem is used in the zone of plastic flux.

Von Mises Yield Criterion

To add the Mises plasticity to the Hook material, select the section for setting material properties on the Command Panel (Mode - **Blocks**, Entity - **Materials Management**).

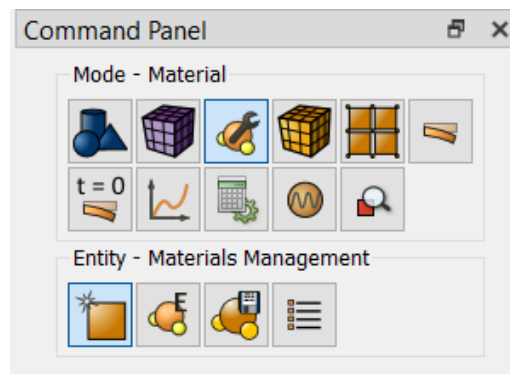

Specify the name of the material. From the left column, drag the Hooke Material inscription into the Material Properties column. Fill in the Values fields accordingly:

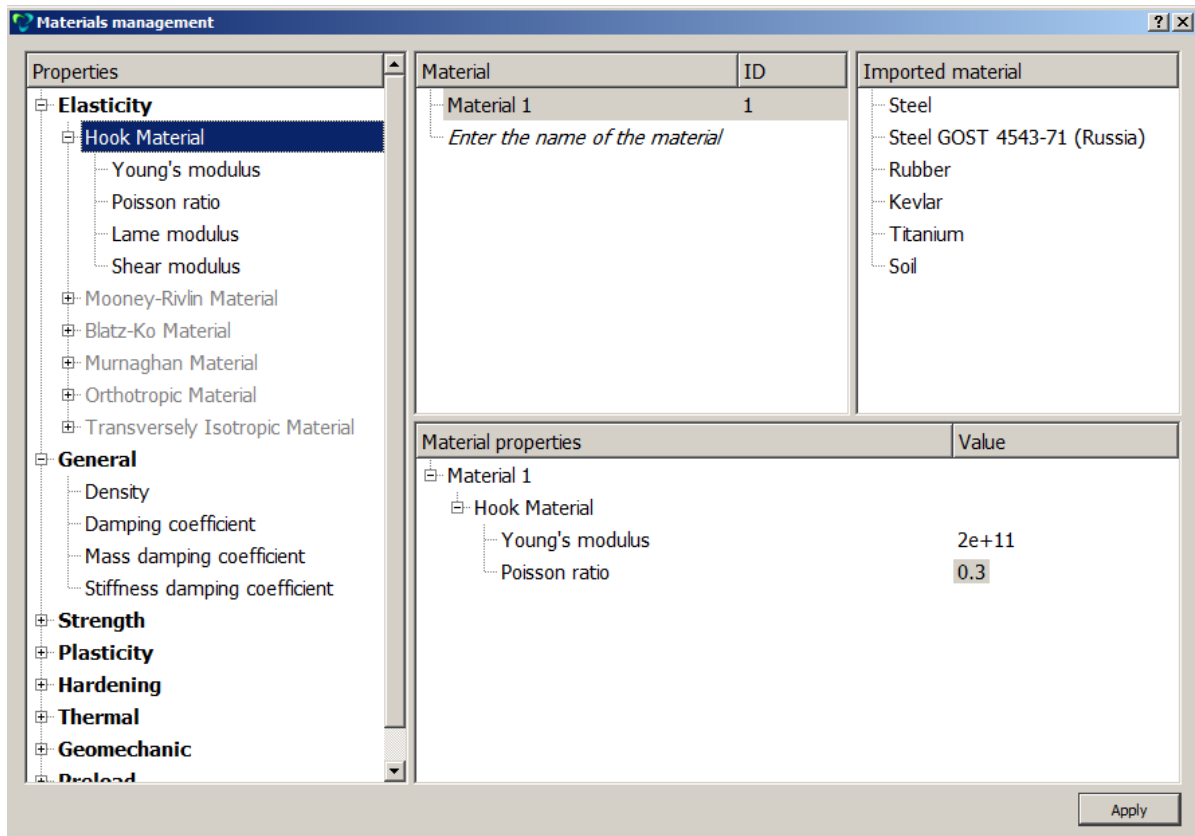

To create the model with the von Mises plasticity without hardening, set elastic properties of the Hook material as well as the **yield strength**:

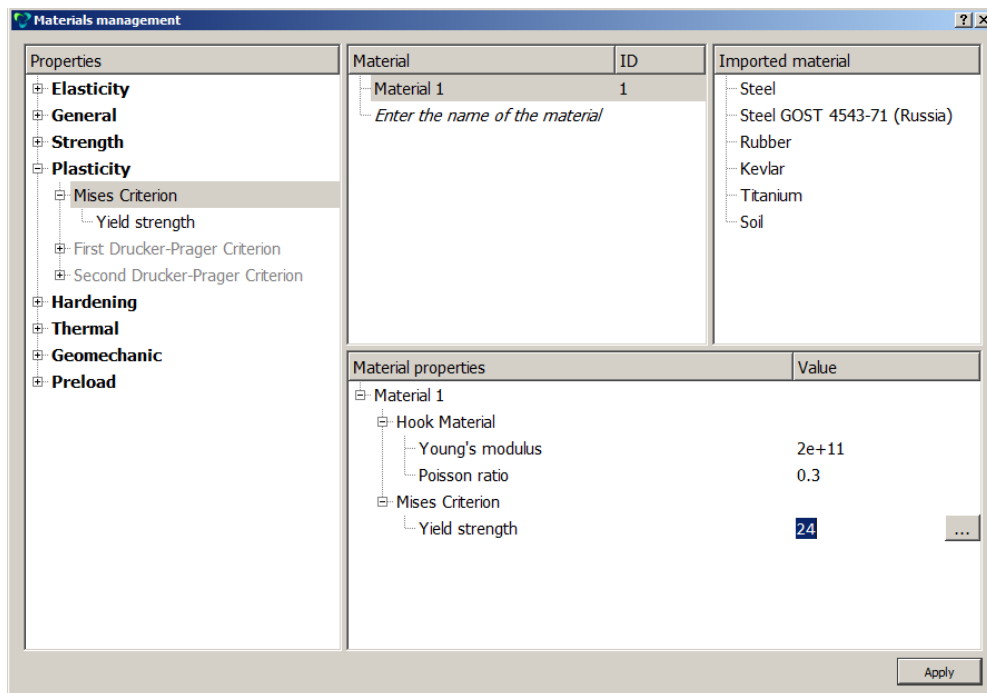

To obtain a model with von Mises plasticity with linear hardening, it is also necessary to enter either the tangential modulus (type 1) or the ultimate tensile strength and ultimate plastic tensile strains (type 2):

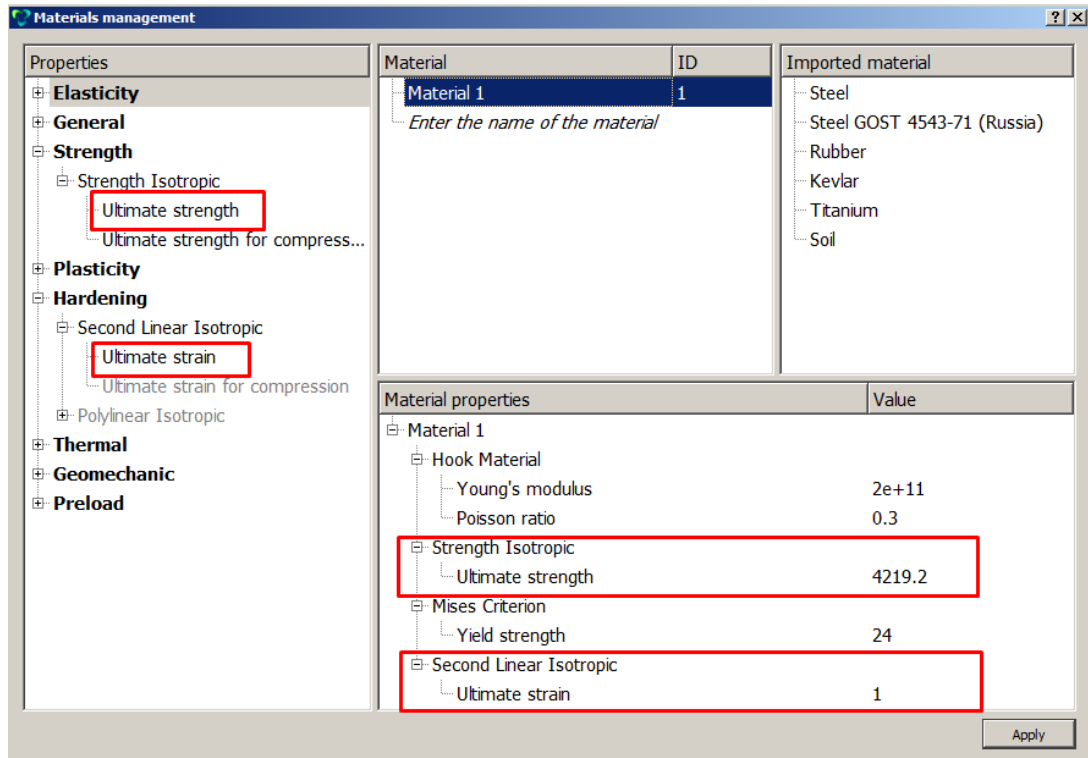

Drucker-Prager Yield Criterion

There are two ways to specify the Drucker-Prager plastic model in the *CAE Fidesys* software package - “**First Drucker-Prager Criterion**”, “**Second Drucker-Prager Criterion**”, which become available in the “Materials Management” widget after specifying elastic constants.

“**First Drucker-Prager Strength Criterion**” implies the setting of the material properties “**Yield strength**”, “**Yield strength for compression**”:

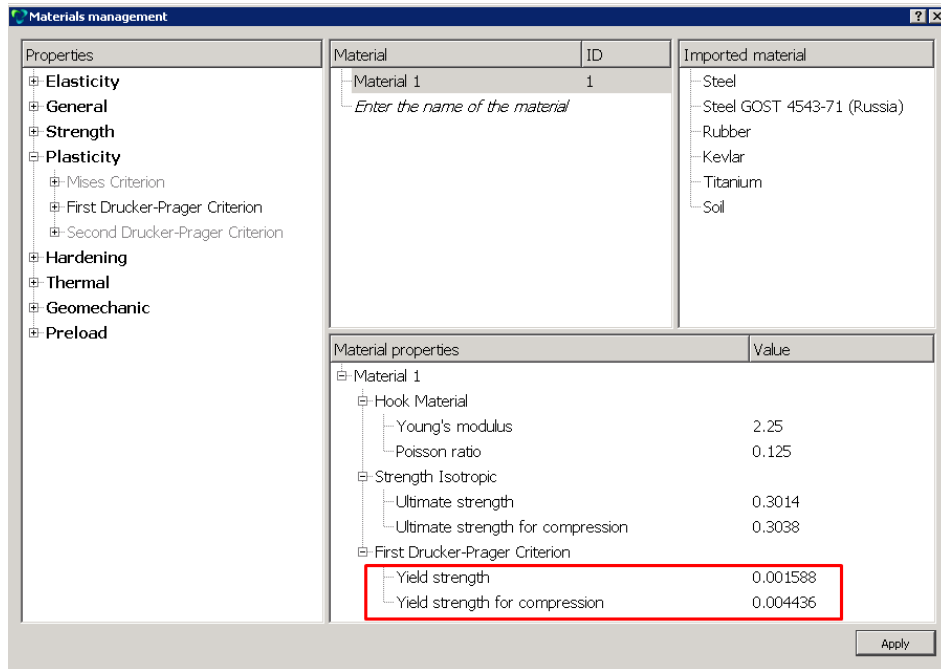

To use the "**Drucker-Prager Second Criterion**" it is necessary to enter the properties of the material "Cohesion", "Internal friction angle", "Dilatancy angle":

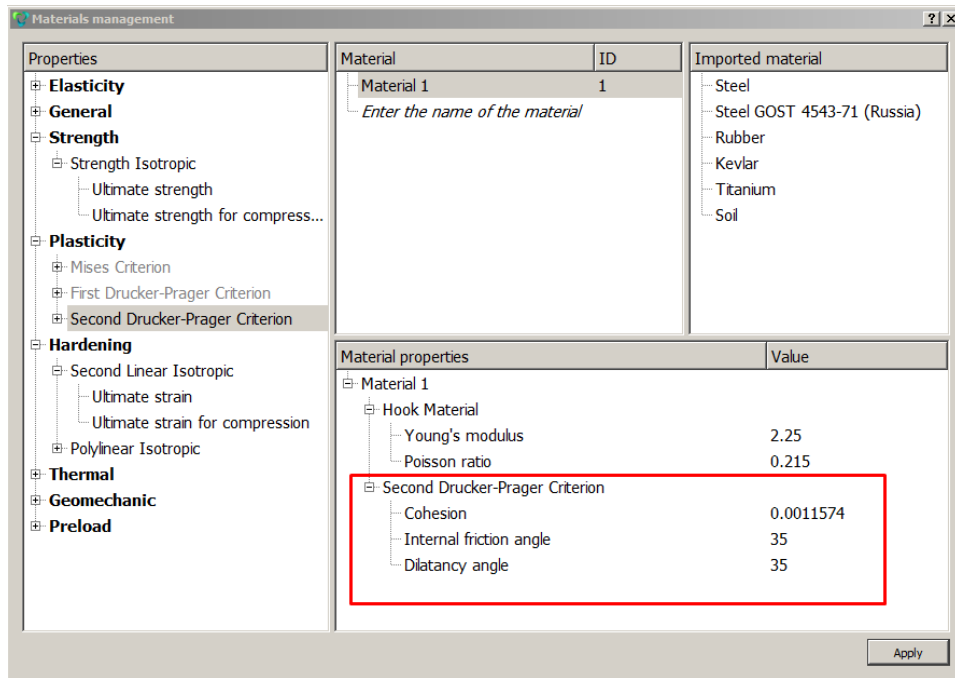

To obtain a Drucker-Prager plasticity model with hardening, also specify the limits of strength and ultimate strain for tensile and compression (available for both the first and the second plasticity criterion according to Drucker-Prager):

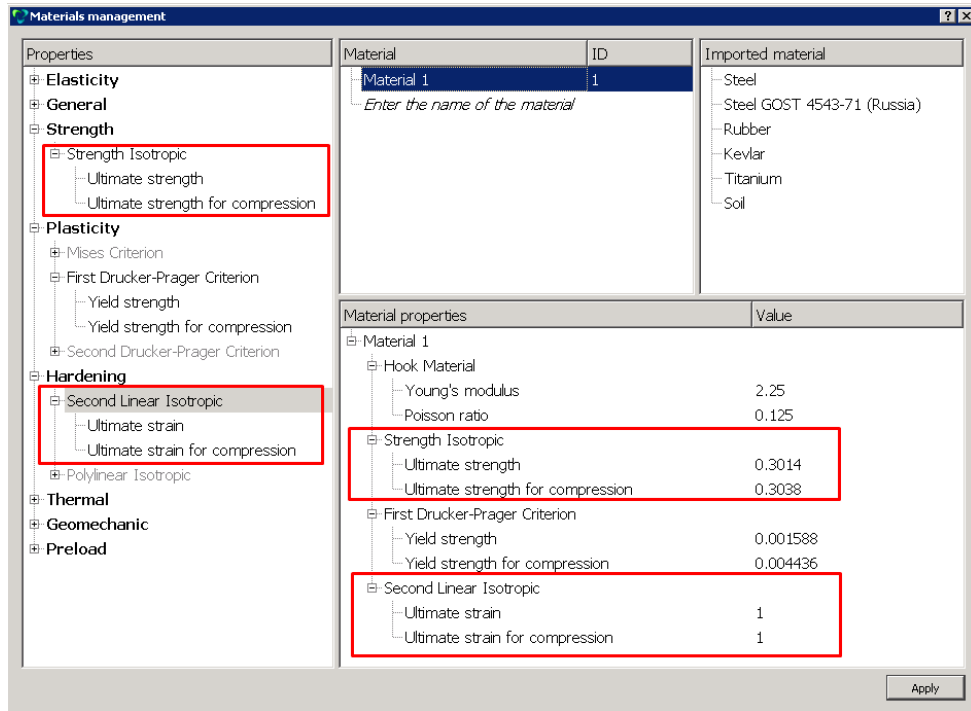

Polylinear hardening

Also, with the Mises plasticity or Drucker-Prager plasticity more general type of hardening is available in CAE Fidesys - polylinear hardening, for which you need to fill in the table property of the material “**Sigma(epsilon) curve**” material (in the table pairs of values from the strain on plastic component “plastic component of deformations ϵ_{11} ” - “true stress S_{11} ”):

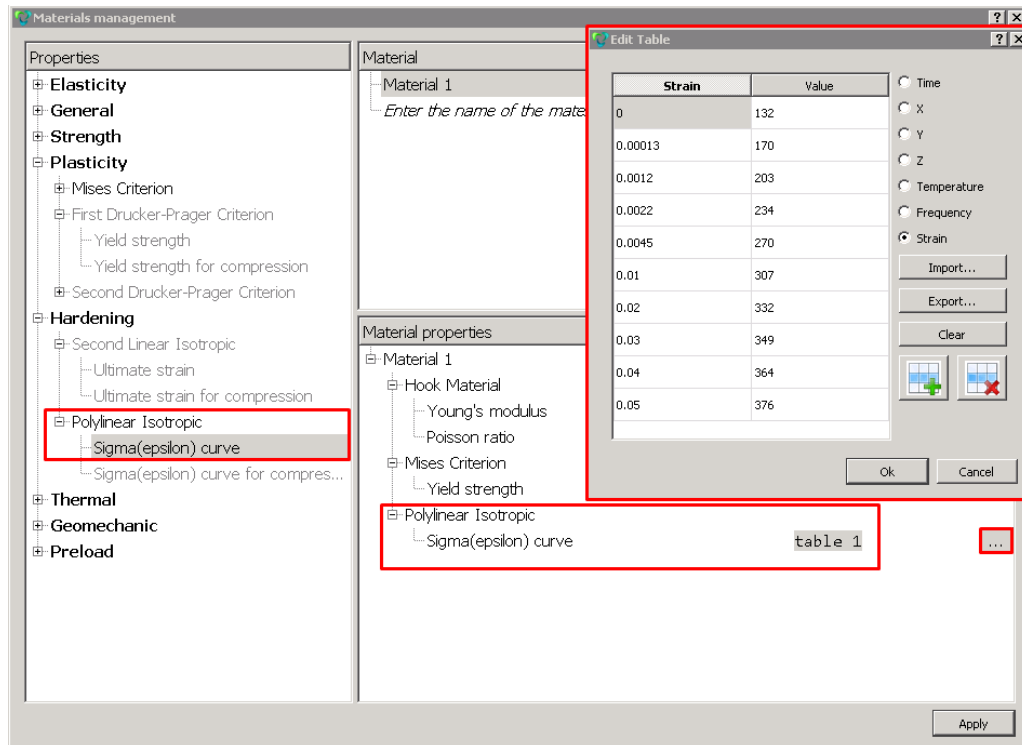

Element Types (for Yielding Models)

CAE Fidesys supports the solution of elastoplastic problems for the following types of already existing finite elements:

- Solid elements (3D/2D).

Orthotropic Thermoelasticity

To calculate orthotropic thermoelasticity, it is necessary to set elastic ($E_x, E_y, E_z, \nu_{xy}, \nu_{xz}, \nu_{yz}, G_{xy}, G_{xz}, G_{yz}$) and thermoelastic ($\alpha_1, \alpha_2, \alpha_3$) characteristics of the material. In the case of calculating an orthotropic volumetric body, the constants will refer to the CS of the block, in the case of orthotropic thermoelasticity of shells, to the CS of the shell elements. The CS of the shell elements are determined by projecting the CS of the shell block onto the plane of each element, taking into account the fact that in each shell element the Z axis will necessarily be perpendicular to the element plane, X will be the projection of the CS block onto the element plane, and Y will be perpendicular to X and Z.

Blocks Operations

A block contains an element type, ID and the name of the geometric model of the material. It is recommended to create several blocks if several materials or several types of geometric entities are used in the calculation.

For example, if a structure contains solid and shell elements, it is necessary to create a block for each type of element. If the construction consists of beams with different types of sections, then for each type of section you need to create your own block.

The sequence of operations with blocks can be schematically represented as follows:

- Create block specifying geometric Entity ID;
- Assign the material to the block;
- Assign the element type to the block.

Let us consider these steps in detail.

1. To create a new block go to Mode – **Blocks**, Entity – **Block**, Action – **Add**.
2. In the Entity list drop-down menu, select the type of geometric objects that will be included in the block.

Click **Apply**.

You can find out the ID of the geometrical entities united into the block as follows:

- in the Model Tree on the left;
- by clicking on geometrical objects you are interested in – their ID will automatically appear in the appropriate field.

The block ID field requires a serial number.

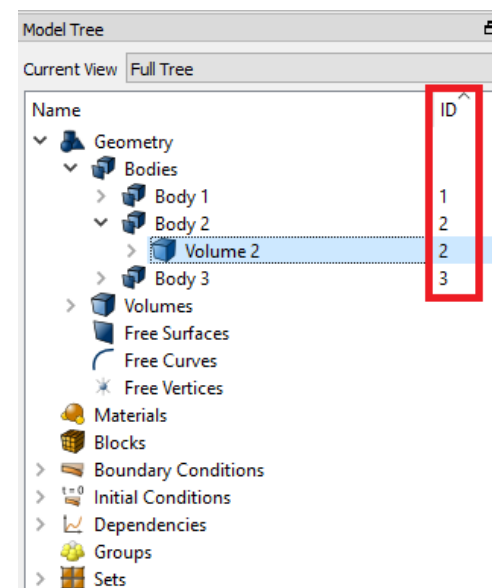

Note: Created block is displayed in the Model Tree on the left in the section **Blocks**.

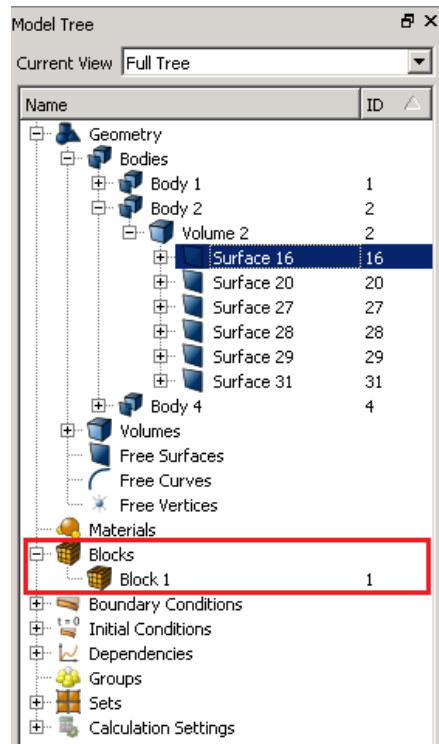

To look through the list of the geometric entities united into the block, enter in Command Line

List block 1.

In the Console, you will see the list of entities united into the block.

3. To assign the material and the element type to the block, select **Block – Block Properties/Parameters**.

To assign a material to a block, select one of the available (pre-created) materials in the Material drop-down list.

To set a coordinate system for a block, select one of the available (pre-created) coordinate systems in the corresponding drop-down list.

The choice of the category of elements depends on the desired characteristics of the model itself. In the Category field, select the item that corresponds to the entity of the object added to the block. The following categories are available in CAE Fidesys for the respective element types:

- **Solid:** SOLID
- **Plane (2D):** PLANE
- **Shell:** SHELL
- **Beam:** BEAM
- **Spring:** SPRING
- **Point mass:** LUMPMASS
- POINT

For more information about the types of elements, see the section Types of elements (CAE Fidesys Help).

If no element type is assigned to the block, the program selects it by default based on the type of geometric object contained in the block. In this case, the following rules are used:

- In volumes, meshes are generated from SOLID elements
- Meshes are generated on surfaces from SHELL or PLANE elements
- Curves generate meshes from BEAM or SPRING elements
- Vertices correspond to single-node LUMPMASS elements
- Spring: SPRING
- Point mass: LUMPMASS

Depending on the selected element category, a special button may appear below to set specific properties of a beams, shells, springs or point mass elements. When you click on the button, a new window should appear with fields for entering the properties of the specified elements.

To set the order of the element, specify. Thus, order 2 corresponds to the choice of an element of the second order, where intermediate nodes are added on the faces. The order of element 3 and further means that the calculation will be carried out by The Spectral Element Method of the corresponding order.

NOTE: Nodes corresponding to the higher order of approximation are positioned according to curved geometry by default. To change this rule, you can use the command:

set node constraint [ON | off | smart]

The off setting corresponds to the arrangement of higher-order nodes without regard to curved geometry. They occupy middle positions between the corner nodes of the elements: at the midpoints of straight edges, at the centers of flat faces, etc. The smart setting ensures that curvature is taken into account only when it does not degrade the quality of the elements.

Setting Shell Properties

CAE Fidesys supports shell elements SHELL.

To calculate thin-walled structures modeled by shell finite elements, it is necessary to specify the geometric parameters of shell sections: thickness and eccentricity. These geometric parameters are assigned to the element block.

CAE Fidesys supports SHELL / SHELL4 / SHELL8 / TRISHELL / TRISHELL3 / TRISHELL6 shell finite elements, spectral shell elements are also supported.

To set the properties of the shells - thickness and eccentricity - go to **Mode - Blocks, Object - Block - Action - Block Properties/Parameters**. The category when assigning an element type to a block must be Shells.

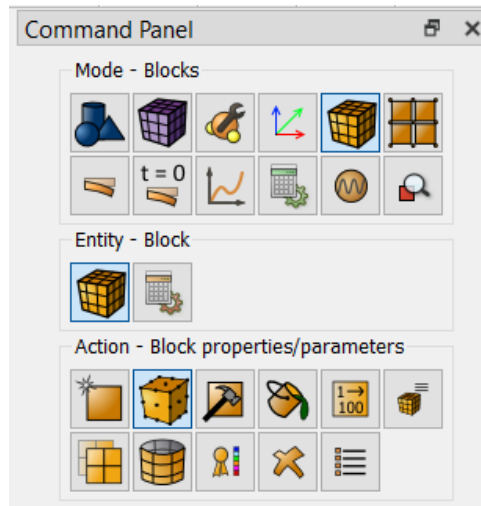

When you select the Shell category, the Block Properties ID button should appear. In this case, it is possible to create a new section of the shell or select existing IDs.

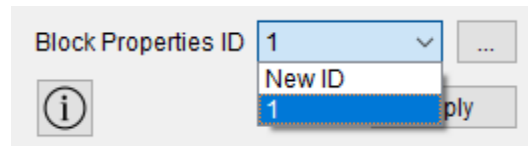

When you click on the "ellipsis" button, a new window opens for setting the necessary parameters. Specify:

- The thickness of each layer of the shell
- Material for each layer of the shell
- Angle
- Coordinate system
- Eccentricity

NOTE: The eccentricity for the shell element varies from 0 to 1 and determines the distance between the shell surface, considered in the framework of the geometric or mesh model, and the middle surface of the shell (in fact, the thickness offset of the middle surface relative to the upper surface of the shell in lobes). By default, the eccentricity is set to 0.5.



Viewing a shell section in a 3D view is possible in the CAE Fidesys preprocessor by clicking the Show 3D View button.



3D shell cross section view is possible in the *Fidesys Viewer* postprocessor by clicking 3D-view button in the default string.

Multilayer Shells

To specify a multi-layer shell, add another row to the table and fill in as required by the task condition.

Set Shell Properties 1 ×

	Thickness	Material	Angle
2	1	Steel	0
1	1	Steel	0

Clear

Thickness

Eccentricity

Invert Layers Direction

Shell thickness change for SEM

Apply

Rotation of the Stress-Strain State of the Layer in the Element Coordinate System

In the case of modeling multilayer laminates with layers lying at an angle to any coordinate system, first a coordinate system is created for a block with shell elements. This coordinate system is projected onto each element and, accordingly, its own coordinate system is formed in each element.

When setting the laminate reinforcement scheme, it is necessary to set the thickness of each layer and the angles of their reinforcement relative to the SC of the block elements. Thus, to analyze the stresses in the layers, it is necessary to derive the stresses in the SC of the layer. In this case, XX stresses can be interpreted as stresses along the fibers, YY stresses across the fibers, and XY as shear stresses in the layer.

To display stresses in the element (and layer) coordinate system, it is necessary to use the "Coordinate systems" filter in the postprocessor: Filters - Alphabetical index - Coordinate systems.

Derivation of Stresses by Layers

To display stresses in a layer of a multilayer shell in Fidesys Viewer, you must use the "Coordinate system Conversions" filter.

In the "Properties" of the applied filter, it is necessary to select the voltages in the corresponding layer as an input array and select the corresponding layer number in the "Layer coordinate systems" tab.

The screenshot shows the 'Properties' panel on the left and a list of available data items on the right. The 'Properties' panel has tabs for 'Properties', 'Information', and 'Points information'. Under 'Properties', there are buttons for 'Apply', 'Reset', 'Delete', and a help icon. A search bar is present with the text 'Search ... (use Esc to clear text)'. Below that, the 'Properties (CoordinateSystem)' section is active, showing a dropdown menu for 'Stress (shell layer 1)'. There are checkboxes for 'To spherical coordinates' and 'To cylindrical coordinates'. The 'Center' field has three input boxes with values 0, 0, and 0. The 'Z Axis' field has three input boxes with values 0, 0, and 1. The 'Layer Coordinate Systems' section has a tree view with 'layer 1' checked and 'layer 2' unchecked. The 'Display (UnstructuredGridReq)' section has several icons. The list of available data items on the right includes: Displacement, Local Coordinate System Vector X (shell layer 1), Local Coordinate System Vector X (shell layer 2), Local Coordinate System Vector Y (shell layer 1), Local Coordinate System Vector Y (shell layer 2), Local Coordinate System Vector Z (shell layer 1), Local Coordinate System Vector Z (shell layer 2), MiddleSurfaceForces, MomentsShell, Normal, Normal in Current, Rotation, Strain, Strain (shell layer 1), Strain (shell layer 2), StrainBottomSide, StrainBottomSide (shell layer 1), StrainBottomSide (shell layer 2), StrainTopSide, StrainTopSide (shell layer 1), StrainTopSide (shell layer 2), Stress, **Stress (shell layer 1)**, Stress (shell layer 2), StressBottomSide, StressBottomSide (shell layer 1), StressBottomSide (shell layer 2), StressTopSide, StressTopSide (shell layer 1), and StressTopSide (shell layer 2).

After applying this filter, an array of stresses in this layer will appear in the coordinate system of this layer.

The screenshot shows a filtered list of data items. The items are: Stress, Stress (shell layer 1), **Stress (shell layer 1)_CS layer 1**, Stress (shell layer 2), StressBottomSide, StressBottomSide (shell layer 1), StressBottomSide (shell layer 2), StressTopSide, StressTopSide (shell layer 1), and StressTopSide (shell layer 2). The item 'Stress (shell layer 1)_CS layer 1' is highlighted in blue.

Result:

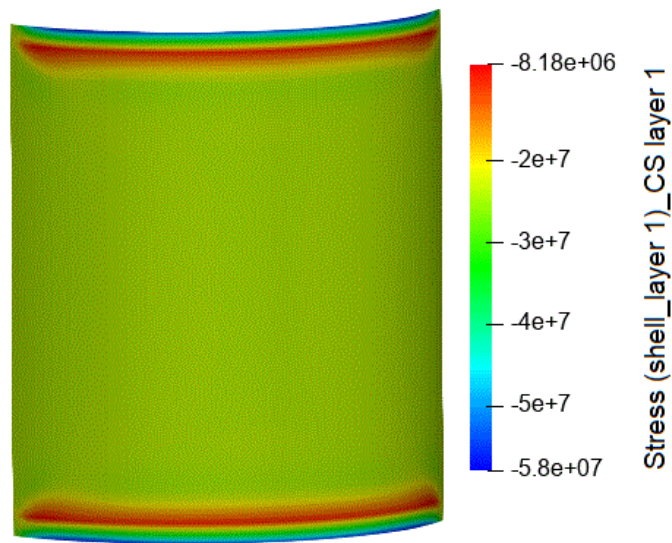

Setting Beam Properties

CAE Fidesys supports beam elements BEAM.

To calculate structures modeled by beam finite elements, it is necessary to specify the geometric parameters of the sections of these elements. The geometric parameters of the sections are assigned to a block of elements.

CAE Fidesys supports first and second order beam elements -BEAM / BEAM2 and BEAM3, respectively. To define the sections of beams using geometric characteristics or moments of inertia, go to **Mode - Blocks, Object - Block - Action - Properties / block parameters**. The category when assigning the element type to a block must be Beams.

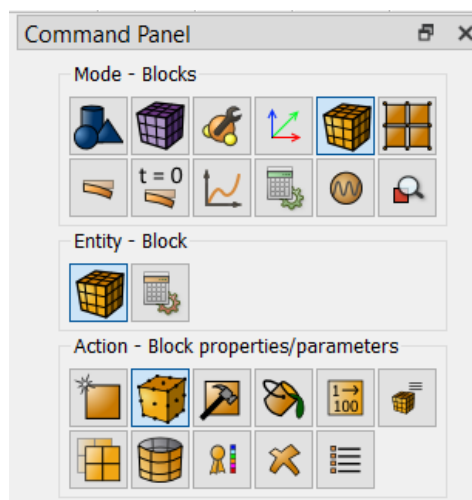

When you select the Beam category, the Block Properties ID button should appear. In this case, it is possible to create a new section of the beam or select existing IDs.

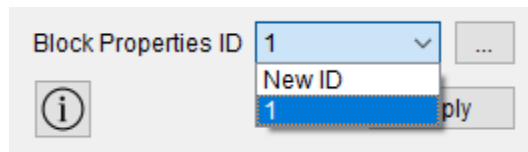

When you click on the "ellipsis" button, a new window opens for setting the necessary parameters. Specify

- block ID;
- quality of the cross-section mesh;
- angle of rotation of the local coordinate system;
- section profile and corresponding dimensions to it.

Click Apply.

CAE Fidesys supports the following beam cross sections types:

- Rectangle;
- Ellipse;
- I-Beam;
- Channel;
- Corner;
- T-Beam;
- Z-Beam;
- Hollow Rectangle;
- Trough profile;
- Circle With Offset Hole;
- setting the section using moments of inertia.



The 3D view of the beam section is possible in the CAE Fidesys preprocessor by clicking the Show 3D Beam View button.



3D beam cross section view is possible in the **Fidesys Viewer** postprocessor by clicking 3D-view button in the default string after the calculation is complete

For sections defined using moments of inertia only, the 3D view is not available.

Specifying Sphere Element Properties

CAE Fidesys supports point masses (lumpmass elements).

To set the properties of the point mass, go to **Mode - Blocks, Object - Block - Action - Properties / block parameters**. The category when assigning the element type to the block must be Lumpmass.

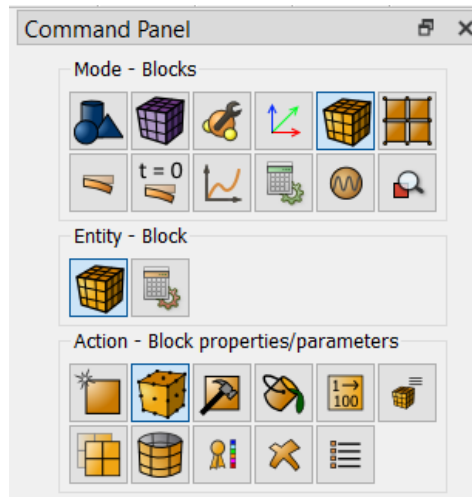

When you select the Point Mass category, the Set Sphere Elements Properties button should appear. When you click on it, a new window opens for setting the required parameters. Indicate:

- block ID;
- mass;
- Inertia moment.

Click **Apply**



View cross sections of the beam in 3D form are possible in the preprocessor **CAE Fidesys** when by clicking the Show 3D view of the beam button



3D point mass view is possible in the **Fidesys Viewer** postprocessor by clicking 3D-view button in the default string.

Set Spring Properties

CAE Fidesys supports springs (spring elements).

To set the properties of the spring, go to **Mode - Blocks, Object - Block - Action - Properties / block parameters**. The category when assigning the element type to the block must be Springs.

When you select the Spring category, the Block Properties ID button should appear. In this case, it is possible to create a new section of the spring or select existing IDs.

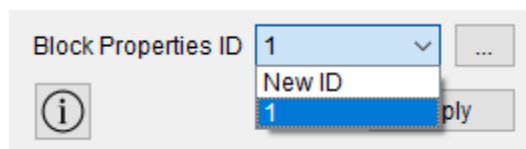

When you click on the "ellipsis" button, a new window opens for setting the necessary parameters. Specify:

- block ID;
- Spring type;
- Corresponding to the type of spring parameters.



3D spring view is possible in the **Fidesys Viewer** postprocessor by clicking 3D-view button in the default string.

Local Coordinate Systems

CAE Fidesys can define the following local coordinate systems:

- Cartesian;
- Cylindrical;
- Spherical.

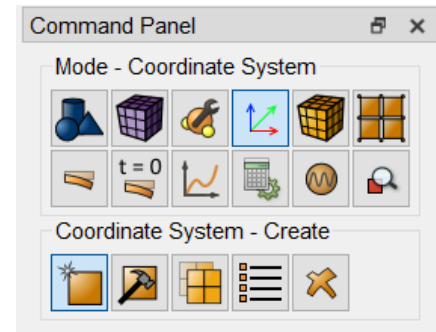
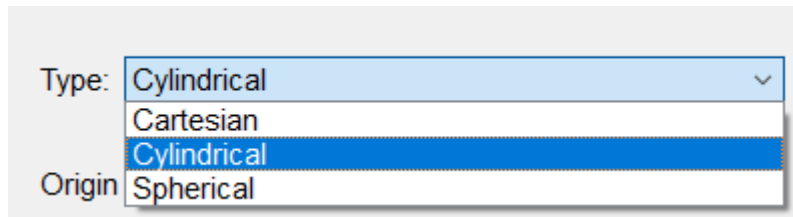

Cylindrical Coordinate System

Cylindrical coordinate system (CCS) is usually used in axisymmetric problems, i.e., in such problems in which the axis of rotation can be distinguished. CCS is used for fastening in radial, tangential or axial direction.

In CAE Fidesys, for the correct use of the CCS, the X axis must be located along the axis of rotation, while the position of the Y and Z axes is not so important. In this case, the X direction will be responsible for the radial direction, Y for the tangential direction, Z for the axial direction. When setting the boundary conditions in which the CCS will be used, this should be taken into account - which axis in the CCS is responsible for which direction.

For example, for the cylinder segment shown in Figure 1, the X-axis of the CCS must be directed along the Z-axis of the global coordinate system. In this case, the X component of the boundary condition in the CCS will be responsible for the radial direction, Y for the tangential direction, and Z for the axial direction.

In the coordinate system settings widget, you can use direction cosine values in the global coordinate system, numbers of reference nodes or vertices.

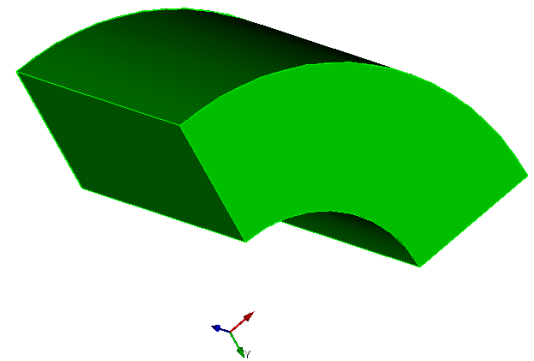

Type: Cylindrical

Origin Entity: Coordinates

X 0 Y 0 Z 0

Direction 1 Entity: Coordinates

X 1 Y 0 Z 0

Direction 2 Entity: Coordinates

X 0 Y 1 Z 0

Apply

Spherical Coordinate System

Spherical CS (SCS) are used for fastening in the radial direction and around two axes Y and Z. Thus, when specifying spherical CS, it is necessary to specify the center point of the CS, from which the radius will be counted, and the direction of the X and Y axes. The Z axis will be perpendicular to them.

In the figure below, X-clamping means radial clamping, Y and Z-clamping means rotational clamping around these axes, respectively.

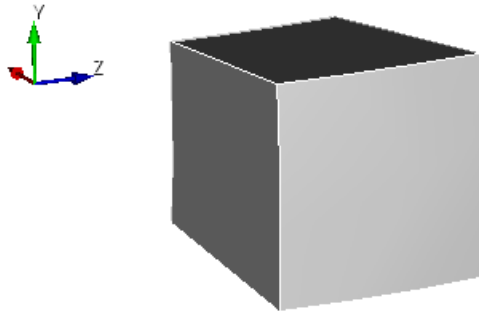

It should be noted that fixation along the Y component will mean fixation of the theta angle, which is in the plane of the radius vector from the center of the CS to the node and the Z axis. Thus, depending on the position of the body relative to the axes, fixation along Y can mean either fixation from rotation y-axis, or fixation from rotation around the x-axis, as shown in the example below.

When you rotate a segment around the Z-axis by 90 degrees, pinning along the Y-axis in a spherical CS will result in pinning around the X-axis.

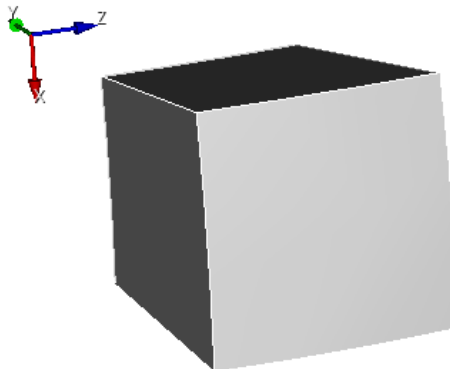

Setting Boundary Conditions

Types of Boundary Conditions

CAE Fidesys supports boundary conditions of the following types:

- Force;
- Pressure;
- Displacement;
- Distributed Force;
- Gravity;
- Stress;
- Acceleration;
- Velocity;
- Angular Velocity;
- Coupling Constraint;
- Contact;
- Absorbing BC;
- Temperature;
- Convection:
- Heatflux;
- Pore Pressure;
- Directional Restraint;
- Periodic BC;
- Radiation;
- Heat Source;
- Volume Heat Source;
- Fluid Flux;
- Fluid Source;
- Volume Fluid Source;
- Additive Printing.

To set boundary conditions, follow these steps:

1. Select Mode— **Boundary conditions** on Command Panel.
2. Select Boundary Condition Type in **Entity** block.
3. Select Action — **Create**. Set the following parameters:
 - ID/Name (assign a new ID, enter a name using letters and/or numbers, or use the system assigned ID);

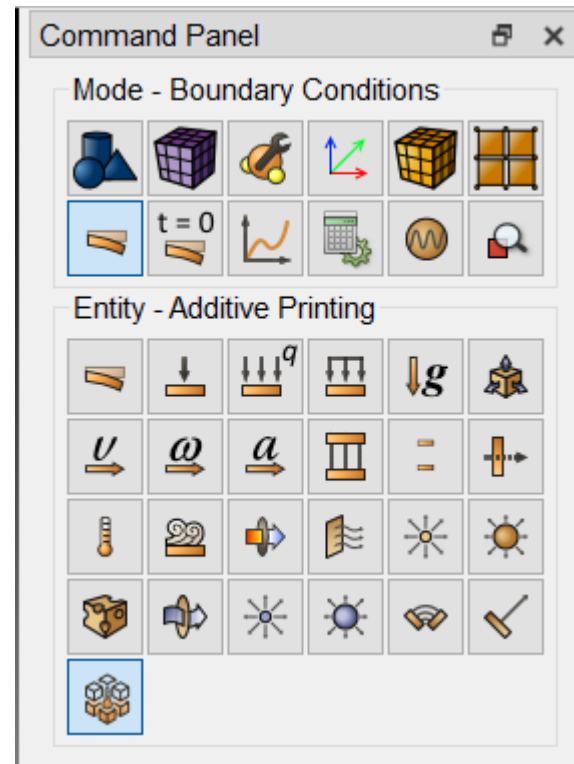

- Entity where the boundary condition is applied (Volume, Surface, Curve, Edge, Vertex, Node, Nodeset, Element, Side, Sideset);
- Entity ID(s) (point mouse cursor at the field Entity ID(s) and select the necessary entities with a mouse, their numbers will be entered into the field automatically. If you need to specify several entities, mark them holding down the Ctrl key);
- Other parameters (Value, DOFs, etc.).

4. Click **Apply**.

Using the functionality available on Command Panel you can also see the list of Boundary Conditions, modify or delete the boundary condition you previously set.

Setting Initial Conditions

Types of Initial Conditions

CAE Fidesys supports the following initial conditions

- displacement
- speed
- angular velocity
- temperature
- pore pressure
- initial stress (set in Materials Management)

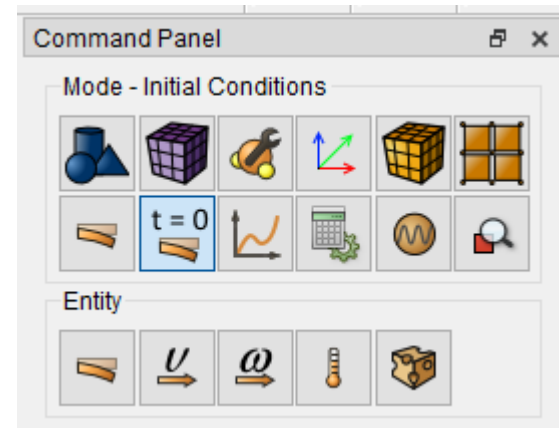

Time/Coordinate Dependency

The time/coordinate dependency can be specified separately for each type of boundary conditions using tabular and formulaic dependencies.

The boundary conditions are set in advance (Mode – Boundary Conditions)..

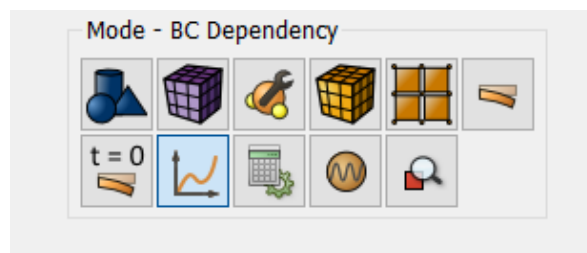

To set the formulaic dependency on Command Panel, select **Mode – BC Dependency**, and in the appeared form:

- Select BC Type;
- Select an individual component or an entire vector for time dependency application;
- Select Dependency Type (formula can be entered manually, you can use the standard formulae for the time dependency);
- Set Dependency Parameters.

Click **Apply**.

To view a tabular data or graphs plotted by a given formula, go to the corresponding tabs in the window BC Dependency. In addition, there is a possibility to export tabular data or to import new tables.

The screenshot shows the 'BC Dependency' window with the 'Formula' tab selected. On the left, a table lists BC types and names:

BC Type	BC Name	ID
Displacement		1
Displacement		3
Displacement		2
Pressure		1

The main area contains a formula editor with the text '-100*sin(x)'. Below the editor is a grid of mathematical function buttons: Clear, +, -, *, /, ^, sin, cos, tan, sqrt, if(A,B,C), (), asin, acos, atan, exp, log, log10, sinh, cosh, tanh, abs, ceil, floor. A note below the grid lists available variables: t (time), x (x-coordinate), y (y-coordinate), z (z-coordinate), T (temperature), w (frequency). An 'Apply' button is located at the bottom right.

Here are standard formulae for the time dependency:

This screenshot shows the same 'BC Dependency' window, but with a dropdown menu open over the formula input field. The dropdown menu lists the following options: Custom (selected), Exponent, Ricker, Berlage, Harmonic, and Delta. The rest of the interface, including the table on the left and the function buttons, is identical to the previous screenshot.

Viewing of the tabular data corresponding to the formula $-100*\sin(x)$:

BC Dependency

BC Type	BC Name	ID
Displacement		1
Displacement		3
Displacement		2
Pressure		1

Formula Table Plot

X	Value
-10	-54.4021
-9.8	-36.6479
-9.6	-17.4327
-9.4	2.47754
-9.2	22.289
-9	41.2118
-8.8	58.4917
-8.6	73.4397
-8.4	85.4599
-8.2	94.0731
-8	98.9358
-7.8	99.8543
-7.6	96.792

Time
 X
 Y
 Z
 Temperature
 Frequency
Import...
Export...
Clear

Apply

Viewing of the graph corresponding to the formula $-100*\sin(x)$

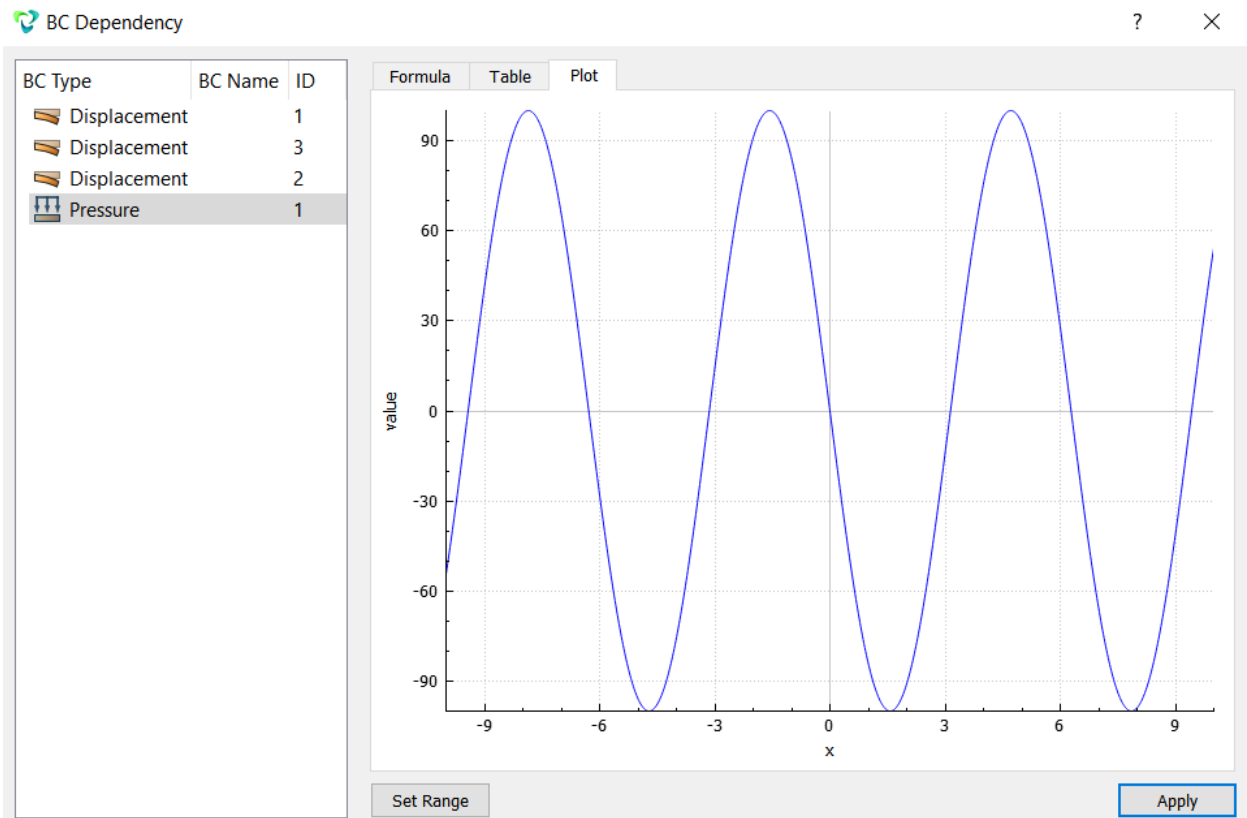

Setting Contact Interaction

Contact problems are highly nonlinear and require significant computer resources to be solved. Thus, to select the model resulting in the most effective solution, it is very important to understand the physical content of the problem. Two factors determine nonlinear nature of contact problems. Firstly, the contact area and therefore the boundary conditions are unknown until you get the solution. Secondly, it is necessary to take friction into account in many contact problems. Effects related to the friction can result in poorly converging problems.

Contact Region

To set contact areas, select the Contact dialogue (Mode - **Boundary conditions**, Entity - **Contact**)

CAE Fidesys implements node-surface and node-curve contact interactions.

Note: if contact conditions are not specified, then the parts in the assembly do not interact. The interaction of assembly parts through the specified contact area means an obstacle to the mutual penetration of parts and the transfer of loads.

It's recommended to assign contact zones to separate surfaces in 3D and lines in 2D. The contact regions should be large enough so that the process of interaction of bodies does not outstep, but at the same time it is recommended to minimize these regions to save computer resources.

Specify which of the entities will be the Master, and which - the Slave.

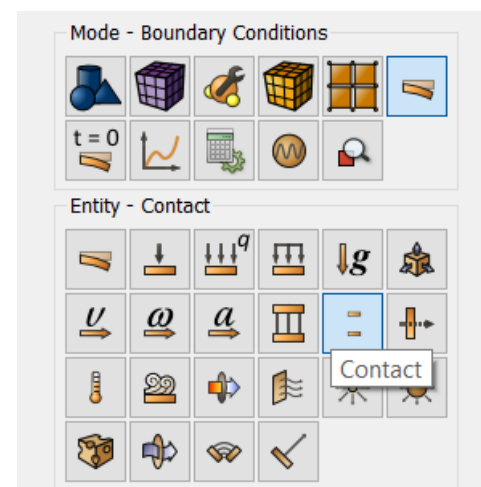

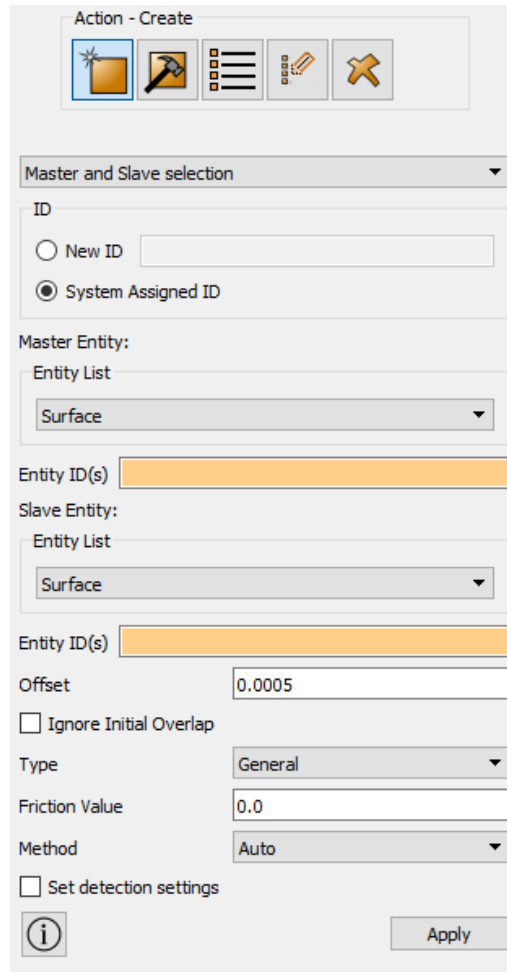

The screenshot shows the 'Action - Create' dialog box. At the top, there is a toolbar with icons for creating, deleting, and editing. Below the toolbar is a 'Master and Slave selection' dropdown menu. The 'ID' section has two radio buttons: 'New ID' (unselected) and 'System Assigned ID' (selected). The 'Master Entity' section has an 'Entity List' dropdown set to 'Surface' and an 'Entity ID(s)' text box. The 'Slave Entity' section also has an 'Entity List' dropdown set to 'Surface' and an 'Entity ID(s)' text box. The 'Offset' is set to 0.0005. There is a checkbox for 'Ignore Initial Overlap' which is unchecked. The 'Type' dropdown is set to 'General'. The 'Friction Value' is set to 0.0. The 'Method' dropdown is set to 'Auto'. There is a checkbox for 'Set detection settings' which is unchecked. At the bottom, there is an information icon and an 'Apply' button.

The Master is simulated by surfaces, and the Slave - by nodes.

When building a contact pair, you should keep in mind that the choice of Master and Slave can cause various results and influence the accuracy of the solution.

Recommendations for the selection of Master and Slave entities:

- If one surface (A) is flat or concave, and the other surface (B) is a sharp edge or bulge, then surface A should be the Master.
- If both contacting surfaces are convex, then the Master surface is assumed to be less convex.
- If both surfaces are flat, the choice of Master and Slave entities is arbitrary.
- If one contact surface has a sharp edge, and the other one does not have it, then the first is taken as a Slave surface.
- If one of the contacting bodies is rigid, then its surface is assumed to be the Master.
- In some cases it is useful to create a symmetrical contact. In addition, each surface is defined as the Master, and as a Slave. It's possible to simulate, for example, the contact of two areas with sharp edges or grooved (undulating) surfaces by this methods.

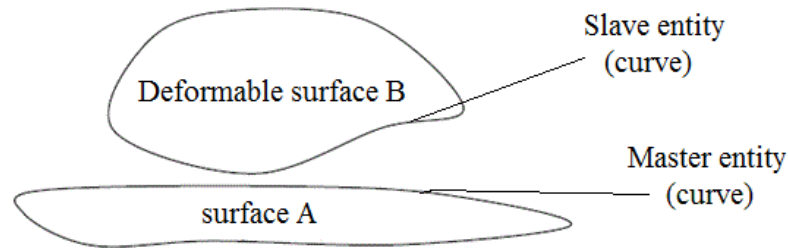

Contact Types

General - the type of contact, which takes into account the force of sliding friction, proportional to the normal reaction. The area of contact can be different.

It contains both areas of adhesion and areas of sliding, which occurs with an increase in the modulus of the tangential force of the limiting value of the friction force (static friction). The indicated coefficient of friction must be non-negative.

Tied - a type of contact in which the main and side objects are connected ("tied") to each other and the contact area does not change under the action of the applied load. Slippage between faces or ribs, as well as their separation (disconnection) is not allowed.

Tied Normal - a type of contact similar to connected, in which the separation of the main and secondary objects in the normal direction is not allowed, but slipping of the contact surface is allowed.

Tied Tangent - a type of contact, similar to the connected one, in which the slipping of the main and secondary objects along the tangent is not allowed, but the opening of the contact surfaces is allowed.

Autoselection of Contact

CAE Fidesys implements the automatic definition of contacting entities. To do this, select Autoselect in the drop-down list and select the corresponding entity in the Geometry panel.

You will see the applied contact pairs on the left side of the screen in the objects tree. Click the name of the desired contact region in the Model Tree to visualize, and it will be highlighted on the model.

Offset - is the distance between bodies at which contact interaction started. It can be considered as the size of a rigid body between the contacting bodies.

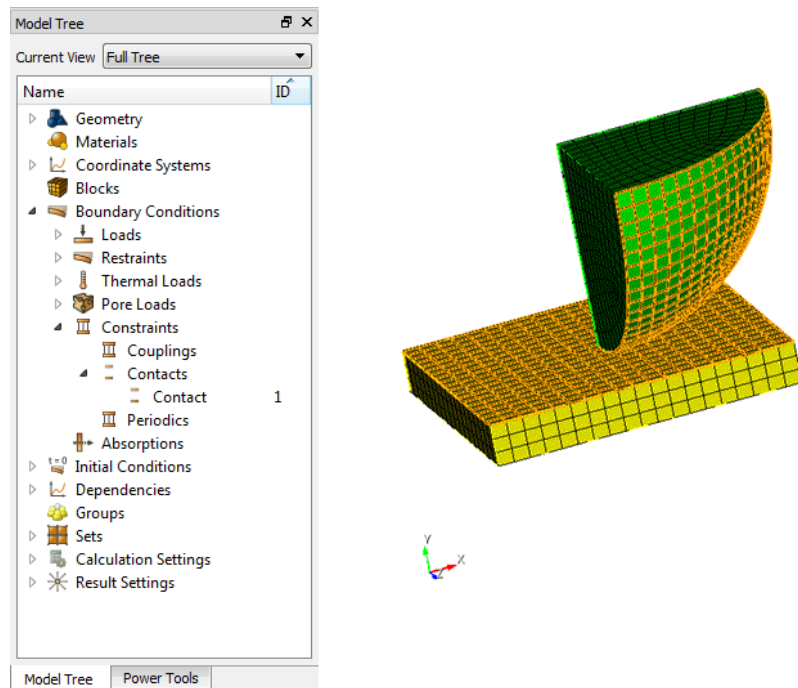

Each contact pair has an individual number (ID) and a set of properties. The number of contact pairs is not limited. To visualize the created contact pair, click the name of the required contact pair on the left in the same tree of objects. The selected pair will be highlighted in yellow on the model.

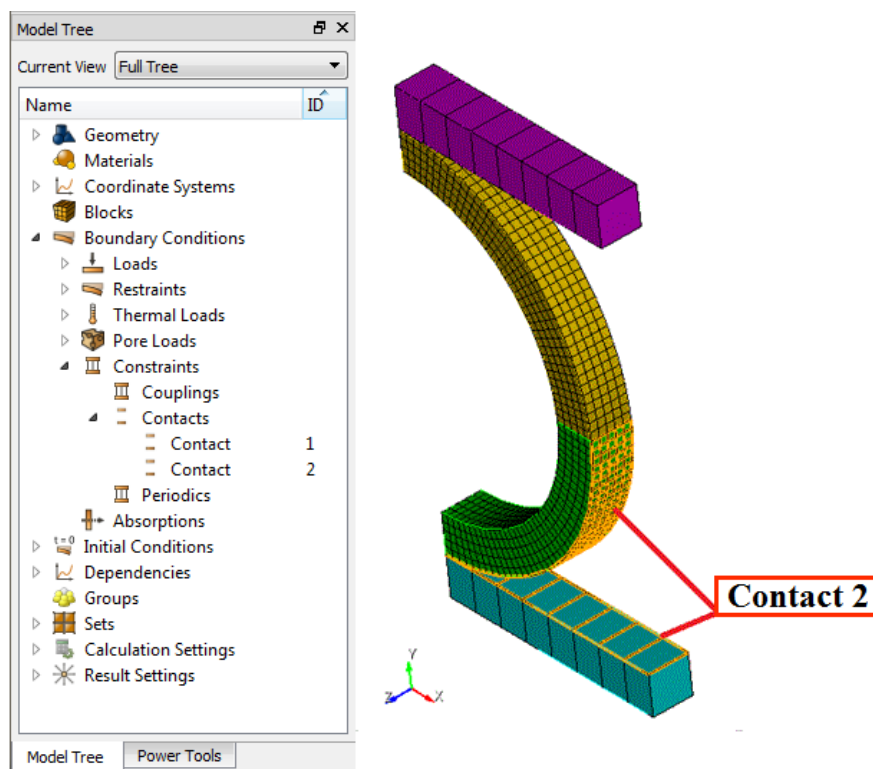

The following contact pair settings are available in *CAE Fidesys*:

- Tolerance (affects the search for contact pairs, as well as the behavior of the contact interaction)

- throughout the calculation)
- Type (General, Tied, Tied Normal, Tied Tangent)
- Friction Value (for general contact)
- Offset (for bolt preload)
- Method

To simulate a bonded contact, select the type of contact **Tied**. Then, if the contact is created, Master and Slave entities merge in all directions so that displacements and stresses are continuous through the contact zone.

If the motion of a rigid body is limited only by contact conditions, it is important to ensure that the elements of the contact pair are in interaction in the initial state. However, in some cases, the definition of interaction can be difficult. This can occur in the following cases:

- body contours can be complicated, and it is difficult to define the point at which the first contact will occur;
- in spite of the fact that the geometric model is constructed without gaps, floating point errors arising while meshing the model can lead to the appearance of small gaps/overlaps between the elements.

For the same reasons, an initial penetration of the Master entity into the Slave one can occur. In these cases, excessively large reactive forces may appear in the contact elements, and this may lead to a **divergence of the solution**.

Therefore, the definition of initial contact is perhaps the most important aspect of building a model for contact analysis.

Contact Algorithm

CAE Fidesys implements the following contact algorithms:

- Penalty,
- Multipoint Constraint (MPC).

For the Auto method, the program automatically selects one of the listed algorithms for solving the contact problem.

The Penalty method is a contact method that requires the setting of contact stiffnesses, that is, the stiffnesses of elastic elements (virtual springs) added by the program to connect between contacted objects.

The stiffness value is calculated by the program independently depending on the properties of the material of the deformable elements, but the user can scale it by multiplying by the required coefficient.

The choice of an appropriate contact stiffness factor is an important task, since an overestimated value can lead to a divergence of the problem, and a too small one can lead to mutual penetration of the contacting bodies.

By default, the contact stiffness multiplier is equal to 1 along the normal and 0.5 along the tangential.

The MPC method is a contact method using connection equations; not nodes are used, but integration points (Gaussian). The MPC method imposes the requirements of lack of penetration and equality of normal stresses, for which the direct elimination method is used. This approach does not require selection of stiffness and gives a solution in one iteration (if the contact zone does not change).

General recommendations for choosing a multiplier for normal contact stiffness:

- for problems with a predominance of bending and movements of rigid bodies, a value from 0.001 to 0.1 is recommended;
- for problems with pair contact, the normal coefficient of contact stiffness can be up to 1000, and for other contact models up to 1.

General recommendations for choosing a multiplier for tangential contact stiffness:

- for problems with a predominance of bending and tangential displacements of rigid bodies, it is recommended to reduce the value;
- The maximum value is 0.5, the minimum value is limited to 0, but it is not recommended to set values less than 0.01.

Elements Type

CAE Fidesys computational algorithms make it possible to simulate a contact with non-conformable mesh. It **does not require** the use of any special finite elements in the contact area to denote the interaction of parts. This approach allows to easily set the conditions for interaction in contact or for connected surfaces.

CAE Fidesys supports the solution of elastoplastic problems for the following types of existing finite elements:

- Solid elements (3D);
- Plane elements (2D).

Contact Status

The behavior of each contact element can be visualized in *Fidesys Viewer* by the **Contact Status** field.

This field has one component, which has one of the following values:

- STATUS = 0 – no contact;
- STATUS = 1 - the contact is defined for the master surface;
- STATUS = 2 - contact defined for slave surface;
- STATUS = 3 – contact without tangential slip;
- STATUS = 4 - Tangential sliding contact.

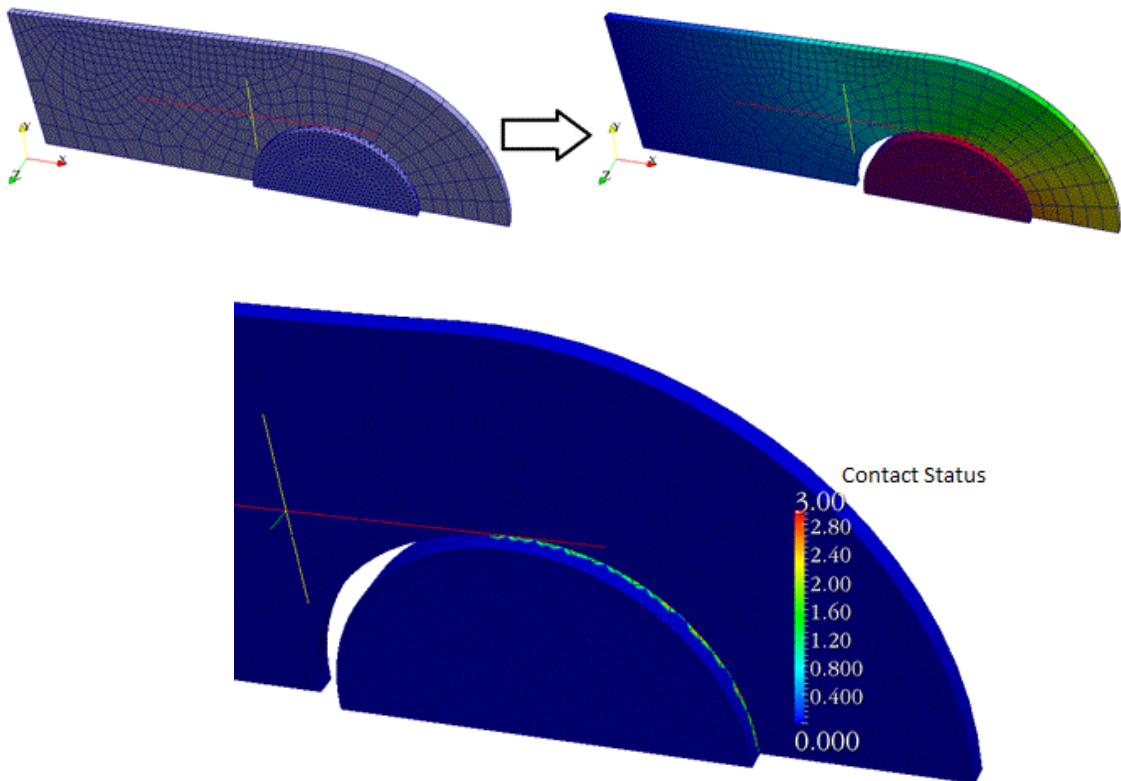

Bolt Pretension

Bolt pretension - a specific type of load that occurs when bolts and studs are tightened - tensile stresses occur in the body of the bolt / stud. Pretension can be modeled using CAE in two ways:

- direct modeling of a threaded connection, taking into account the contact in the threads and threads and the rotation of the nut/bolt, which is an unreasonably resource-intensive procedure
- engineering approach - when tensile stresses are created by cutting the bolt in half and applying forces to the cut surface, thereby creating interpenetration of the bolt halves into themselves. To implement this type of loading, CAE Fidesys uses such a type of contact as "tangentially connected", which allows the contact surfaces to interpenetrate each other, but does not allow their relative transverse displacement (due to which the integrity of the bolt body is violated). supported) and also allows you to set the preload in Newtons via the pin settings.

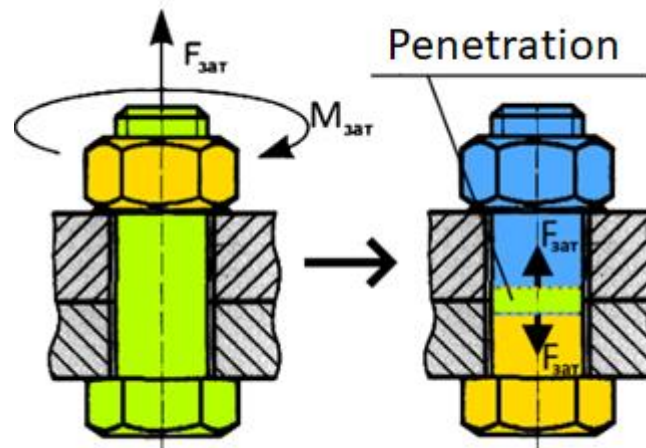

The result, after turning off the flange display through the "Threshold" filter, will look like this:

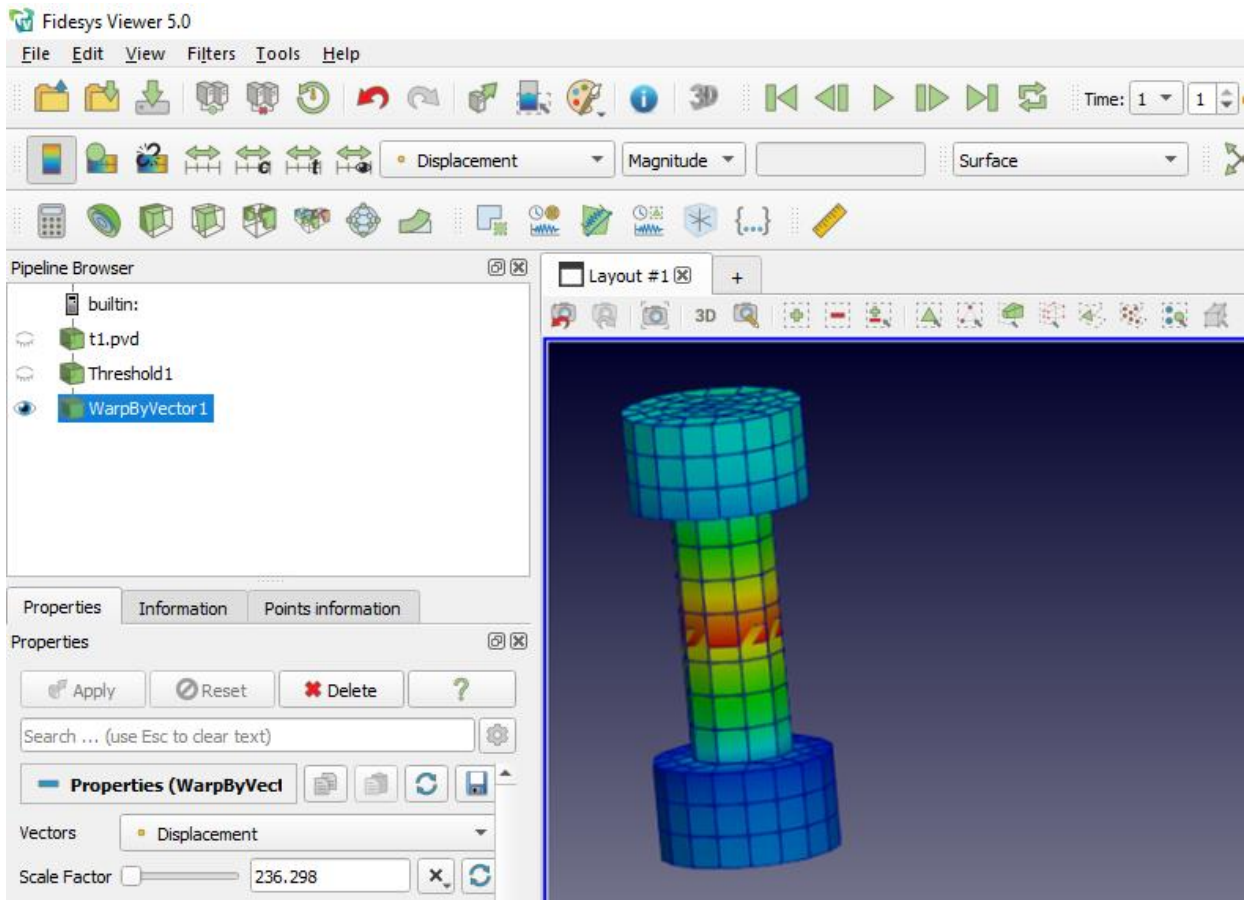

Starting Calculation

Analysis Types

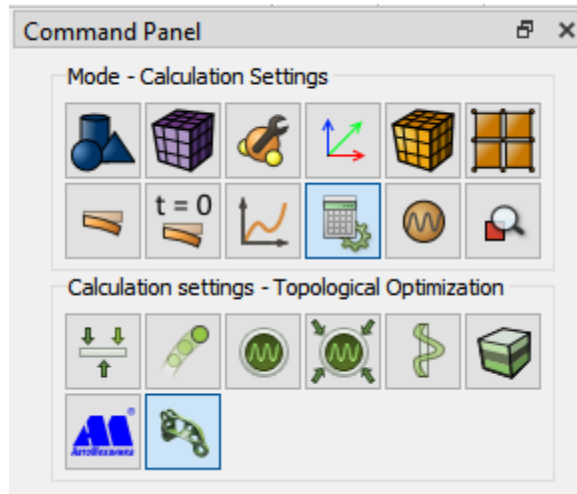

CAE Fidesys includes the following types of analysis:

- Static;
- Dynamic (transient);
- Modal;
- Frequency Analysis (Harmonic);
- Buckling;
- Effective Properties;
- External Integration MBD;
- Topological Optimization;
- Additive Printering (by commands).

When starting calculation follow these steps:

1. Select Mode – **Calculation settings** on Command Panel.
2. Select the necessary type of analysis: Static, Dynamic, Modal, or Effective properties analysis.
3. Set the parameters of the type of analysis you chose: solver type, coordinate system, fields, scheme, time settings (for dynamic analysis), etc.
4. Click **Apply**.
5. Click **Start Calculation**.

You may see the process of calculation in the console. It will also output the messages for the user, including the errors in case of unsuccessful or incorrect end of the calculation. If the system ends the calculation successfully, you will see the “*Calculation finished successfully at <date> <time>*” message in the console.

All the calculations are made in Cartesian coordinate system by default. If necessary, you can also convert the results into cylindrical and spherical coordinate systems (use the appropriate filters in *Fidesys Viewer*).

The dimension of the calculated problem is 2D or 3D. The following types of 2D problem are included:

- Plane stress;
- Plane strain.

Stress, strain and displacement fields are calculated by default. If necessary, you can also calculate principal stresses, strains, and Mises stress intensity (use the appropriate filters in *Fidesys Viewer*).

The following types of solvers of linear systems (systems of linear algebraic equations (SLAE)) appearing while discretizing the problem, are available:

- Direct (LU)
- Iterative.

The following solvers for problems of modal analysis at systems of linear algebraic equations (SLAE) are available:

- Krylov- Schur;
- Arnoldi.

For dynamic load, one of the two calculation schemes can be used:

- Explicit
- Implicit.

Mechanical Models

The following mechanical models are supported:

- Elasticity;
- Plasticity;
- Nonlinear geometry;
- Heat transfer;
- Pore Fluid Transfer.

To choose a model, the user selects the appropriate checkboxes. Selecting multiple checkboxes simultaneously allows setting various combinations of models. For example, the selection of the checkboxes Elasticity and Plasticity gives an elastoplastic model and the selection of the checkboxes Elasticity and Thermal conductivity gives a model of thermoelasticity.

To improve the convergence of nonlinear problems, use the following settings:

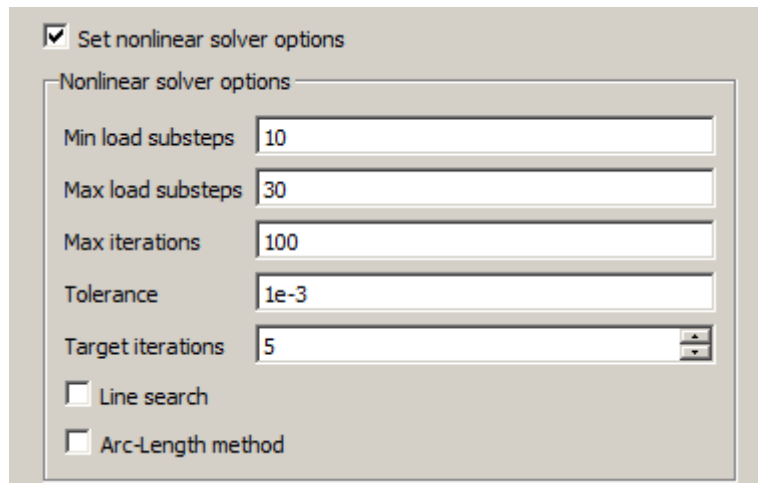

Set nonlinear solver options

Nonlinear solver options

Min load substeps

Max load substeps

Max iterations

Tolerance

Target iterations

Line search

Arc-Length method

For nonlinear problems, check convergence of iterations at each loading step in the file `Convergence.txt`. The file is downloaded into the folder that is created next to the file `*.pvd` which stores the calculation.

For effective performance of several calculations you can use the **Results** on Command Panel (see the section **Result Analysis**).

For visualization and analysis of the obtained results you can use the program *Fidesys Viewer* included into the package.

Multistep Solution

Setting Steps for Boundary Conditions

In *CAE Fidesys* it is possible to specify a multi-step loading through tabular dependence on time or through explicit assignment of steps.

The tabular dependency is set in the section Set time and/or coordinate BC dependency, and you should set the time dependency flag. Setting the load like:

Time	Value
1	5
2	0

means a linear decrease of the value from 5 to 0.

Explicit assignment of steps for boundary conditions occurs in the Load step settings window (Mode - Calculation settings – Static - Set load steps count).

Enter the required number of calculation steps. To open the window of load step settings, click the icon .

Next, specify the required settings:

- Select the BC;
- Click in the left column for the boundary condition for which you want to set active steps of calculation.
- Set the active calculation steps for the selected boundary condition in the corresponding field.
- Setting active steps is possible in the format: "all", "1 2 3 to 5", "1 to 5".

Click **Apply**.

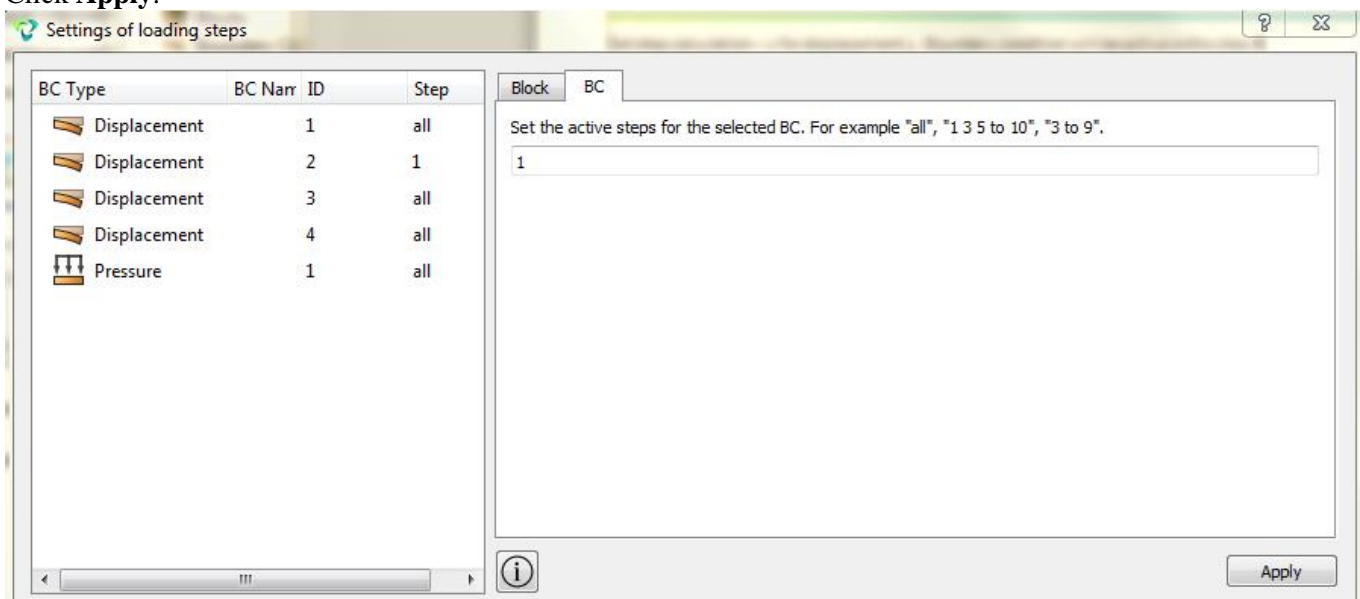

An example of a problem using active calculation steps for boundary conditions (at each step a new movement is added):

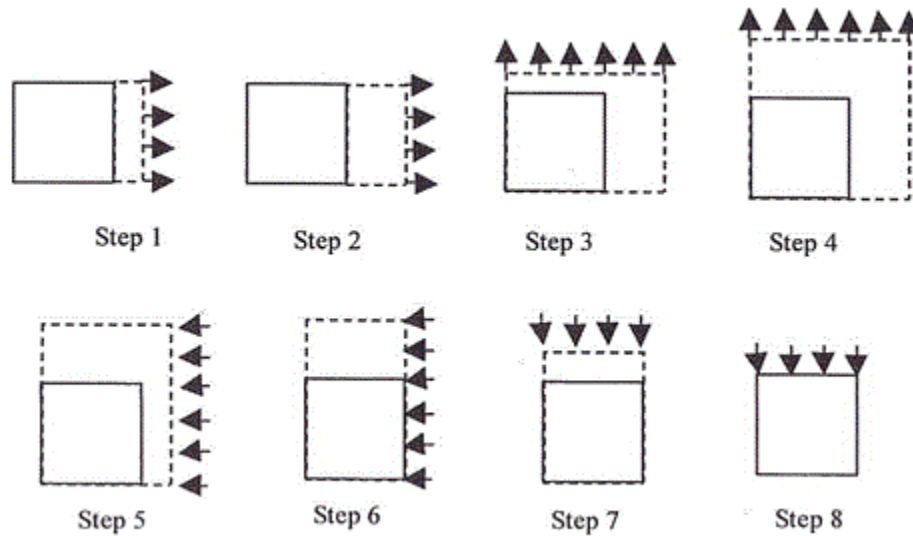

[The solution of the same problem in CAE Fidesys:](#)

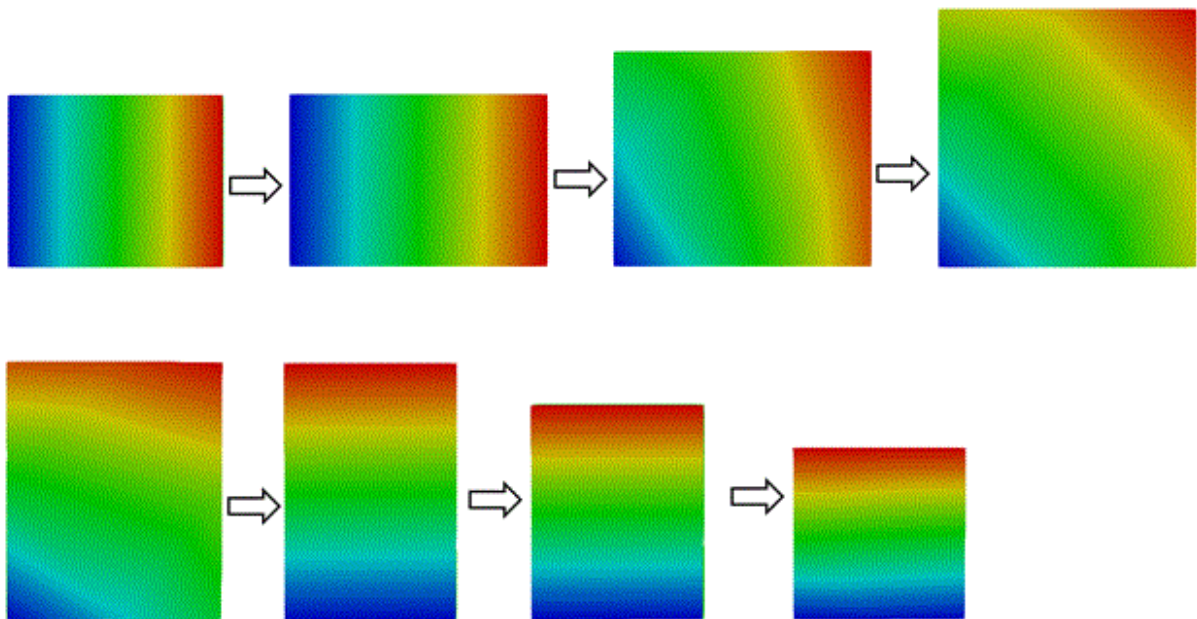

Setting Steps for Blocks (Volumes)

CAE Fidesys allows you to add or remove blocks (volumes \ surfaces added to the block) at specified loading steps.

Adding or excluding blocks in the calculation process takes place in the Setup of load steps window (Mode - Calculation Settings - Static / Transient / Buckling - Set load steps count). In this case, all operations occur on the basis of blocks, therefore for all geometric entities it is better to create a block in advance.

Go to the Settings loading steps window. On the general solver settings panel, enter the required number of calculation steps and click the icon .

Next, specify the required settings:

- Select the Blocks;
- Click on the block in the left column;
- Set the active calculation steps for the selected block in the corresponding field;
- Setting active steps is possible in the format: "all", "1 2 3 to 5", "1 to 5".

Click **Apply**.

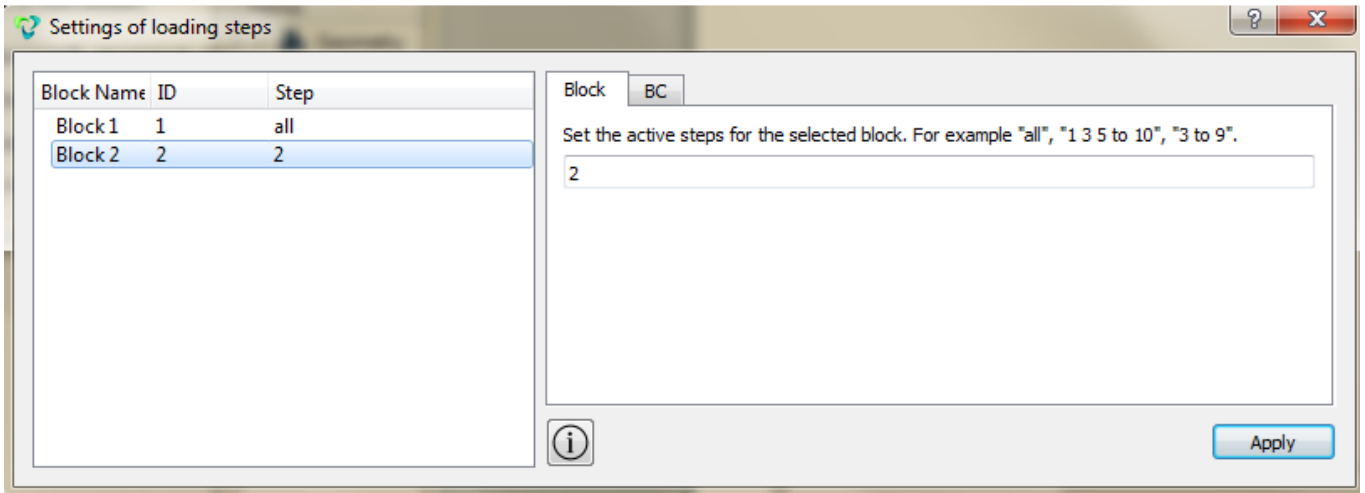

An example of a problem with using active calculation steps for boundary conditions (at the first step, the model is compressed, at the second step one of the fixings is removed, a new volume is added to the deformed model, now two volumes are combined to compress):

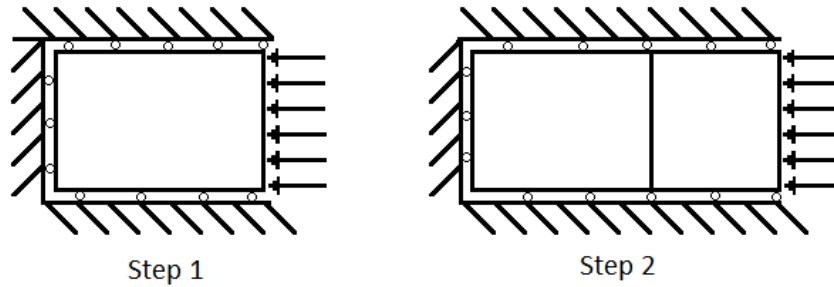

[The solution of the same problem in CAE Fidesys:](#)

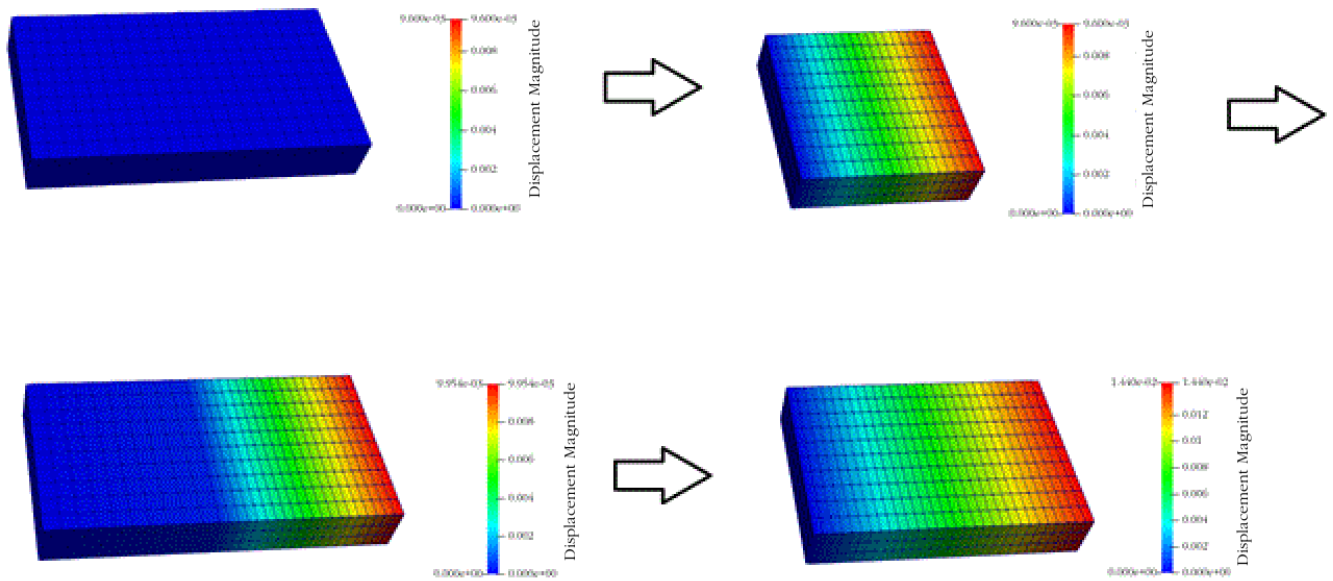

Detailed examples are given below in the Step-by-Step User Guide.

Spectral Element Method

It is a unique feature of *CAE Fidesys* that, in addition to the finite element method (FEM) used by default, enables calculations by spectral element method (SEM).

SEM Brief Description and Advantages

Spectral element method (SEM) is a FEM modification where piecewise functions are used as basic functions consisting of high degree polynomials.

The main advantages of SEM in comparison to FEM:

1. High computational speed as there is no need to solve the system of linear algebraic equations due to diagonal form of mass matrix. The latter is obtained by specific quadrature formula for volume integration.
2. High precision of solution approximation at coarse meshing (low number of elements). The solution error is estimated as

$$\| [u]_{\mathbf{h}} - u_{\mathbf{h}} \| \leq C(N),$$

where

$$C(N) = C_2 h^N \text{ for FEM}$$

and

$$C(N) = C_1 h^N e^{-N} \text{ for SEM.}$$

C_1 and C_2 are constants, h is a characteristic element size, N is an element order, $u_{\mathbf{h}}$ is a numerical solution, $[u]_{\mathbf{h}}$ is an exact solution in mesh nodes.

3. Ability of effective paralleling for OpenMP, MPI and CUDA.

SEM is most effective for the dynamic analysis using an explicit time scheme.

Here are the results of classical problem of wave propagation in 2D plate (size 1x1).

To achieve the computational error 2% and less, it is necessary to generate one of the following meshes:

- 3-noded triangular mesh of 6 390 197 elements (characteristic element size is $4e-4$);
- 4-noded quadrilateral mesh of 1 640 961 elements (characteristic element size is $3e-3$);
- coarse spectral element mesh with 4th element order (only 16 elements are required).

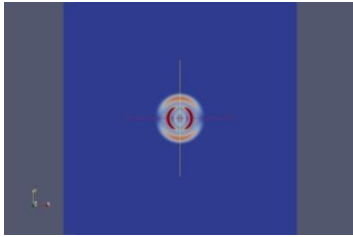

Fig.1. The distribution of the field of displacement magnitude U across the plate at the time t_1

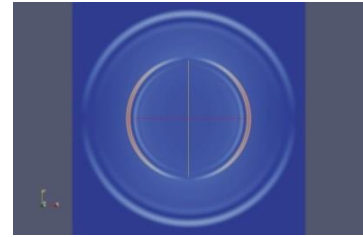
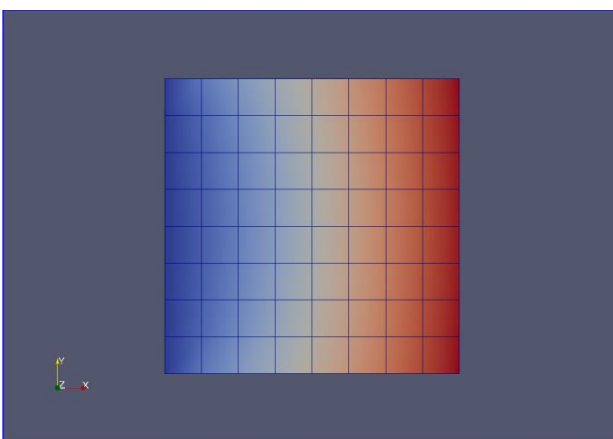
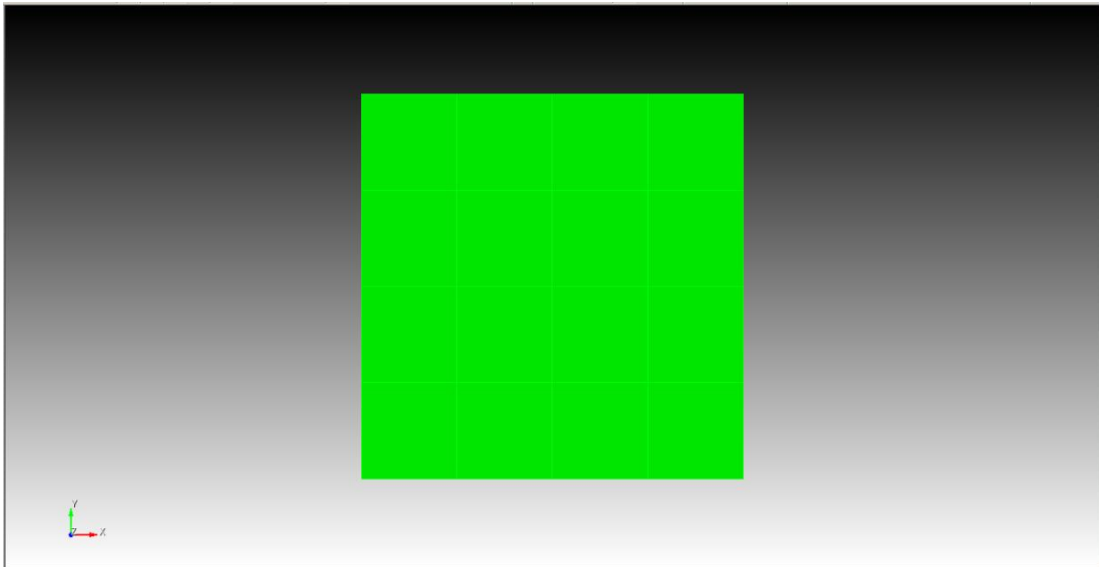
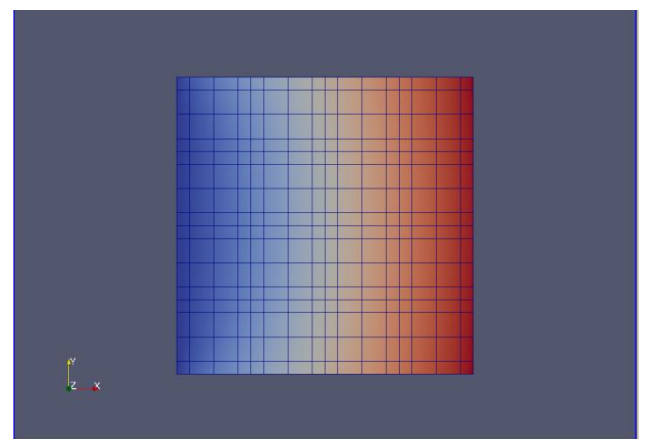

Fig.2. The distribution of the field of displacement magnitude U across the plate at the time t_2

Here are the examples of computation results for different spectral element orders:



2nd spectral element order



4th spectral element order

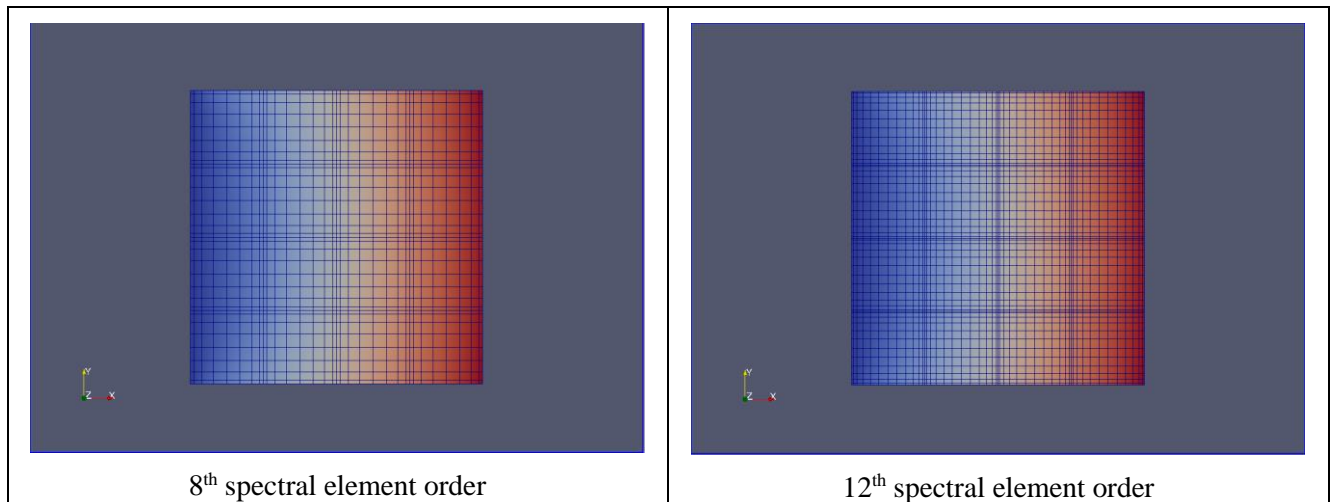

SEM Usage

To use the method of spectral elements instead of the finite element method to solve the problem, set the order of elements 3 and higher (except springs and sphere elements):

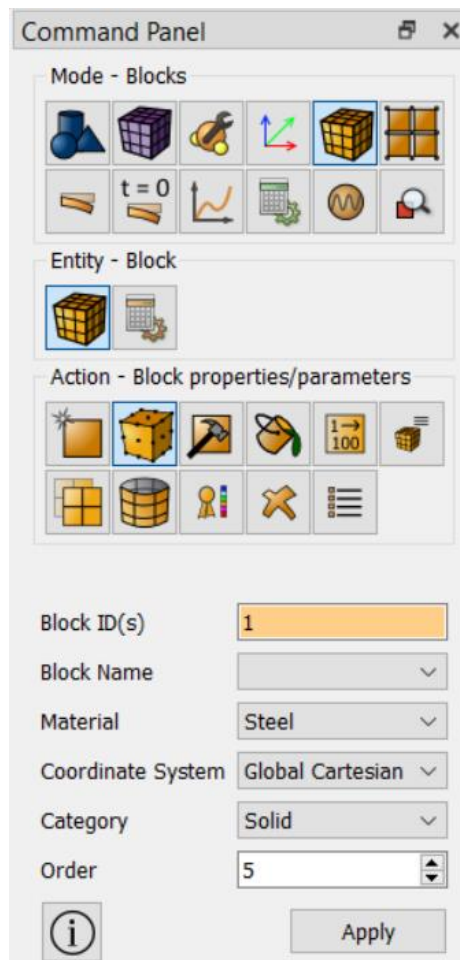

Heterogeneous Materials Effective Property Calculation

In *CAE Fidesys* there is the possibility of calculating the effective properties of an heterogeneous material, for example, composite or porous material.

Geometry of the Model for Effective Property Calculation

A representative volume is a geometric model for calculating the effective properties of the material of nonperiodic structures, i.e. the volume of the material by which you can judge the behavior of the material under deformation in general. This typically means that the size of the representative volume should be approximately an order of magnitude greater than the characteristic pore size or the inclusions in the material. A periodicity cell may be a geometric model for the calculation of the effective properties of periodic structure material.

It is important that the geometric model for the calculation of the effective properties must always be a fragment of material «cut» out of it in the form of a **rectangular parallelepiped**. When calculating, this fragment should be positioned so that the edges of the parallelepiped were strictly parallel to the coordinate planes. The system doesn't provide the automatic checking of the model form and position to calculate the effective properties, so the user should control this – otherwise the calculation can be correctly completed but the results will be misleading.

Examples of valid models for the calculation of the effective properties are shown below. If the tested material is solid (left), then the model for calculating its effective properties must be a solid rectangular parallelepiped with edges parallel to the coordinate planes. If the material contains pores or cavities, then the model for the calculation must contain cavities that may come to the surface (as shown on the right).

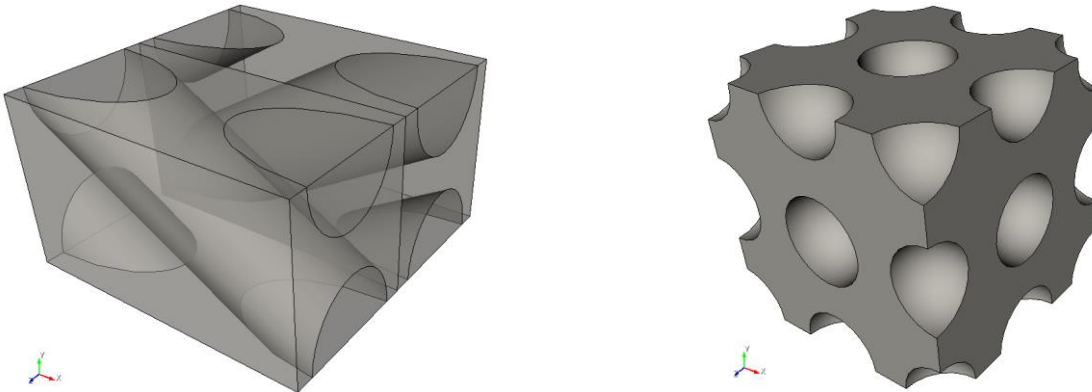

CAE Fidesys can perform the generation of periodicity cell geometry of some composite materials with periodic structure automatically. In the geometry control mode, there is a button «Create Composite» as shown below.

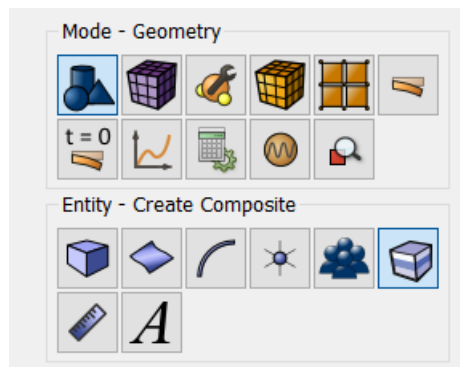

You can create periodicity cells of the following composite types

- Fiber-layered (two-layer) composite;
- single-layer fiber;

- single-layer fiber with shells;
- dispersed fiber reinforced (spherical inclusions);
- dispersed fiber reinforced with shells.

The user needs only to set the parameters of materials and click "Create" - the geometry will be generated automatically by means of the *CAE Fidesys* interface. The user can also create the geometry for the calculation manually by means of the interface or by import. The most important thing is that the geometric model for the calculation of the effective properties is «cut» out of the material in form of the rectangular parallelepiped with edges parallel to the coordinate system in the *CAE Fidesys* interface.

Starting Calculation

After creating the geometry, it is necessary to carry out the same actions as when calculating for static load: blocks creation, finite element mesh generation, material properties setting, etc, except for the boundary conditions application. To calculate the effective properties, it is unnecessary to apply the boundary conditions to the model: when calculating a number of boundary conditions types are automatically applied to the model sequentially; the static load problem is solved for each type; results of all the problems are averaged and, as a result of averaging, the effective properties of the material are calculated. The user only needs to choose the type of boundary conditions: periodic or nonperiodic.

Periodic boundary conditions are preferred if the effective properties of the material of periodic structure are calculated, and the periodicity cell serves as a model for the calculation. For example, if the material is a composite with matrix and inclusions, moreover, the stiffness of the inclusions is much higher than the one of the matrix, and the inclusions are located on the surface of the model for the calculation – in this case it is necessary to use periodic conditions. If the effective properties of the material of irregular structure are studied and a representative volume is a model for the calculation, then the nonperiodic boundary conditions are preferred.

In *CAE Fidesys* the SLAE direct solver is available to calculate the effective properties.

Element Types

CAE Fidesys supports the effective properties calculation for the following existing finite elements:

- Solid elements (3D);
- Plane elements (2D);
- Shell elements (3D);
- Beam elements (3D).

Beam and shell elements can only be used in 3D analysis. Beam elements can be used to model threads / rods, the diameter of which is much (two orders of magnitude or more) smaller than the size of the representative volume (periodicity cells). Shell elements - for modeling membranes / planes, the thickness of which is much (two orders of magnitude or more) less than the size of the representative volume (periodicity cells). The use of beam and shell elements to simulate sufficiently thick rods and membranes is fraught with large errors in calculating the effective properties of the model. It is advisable to model such rods and membranes with volumetric elements.

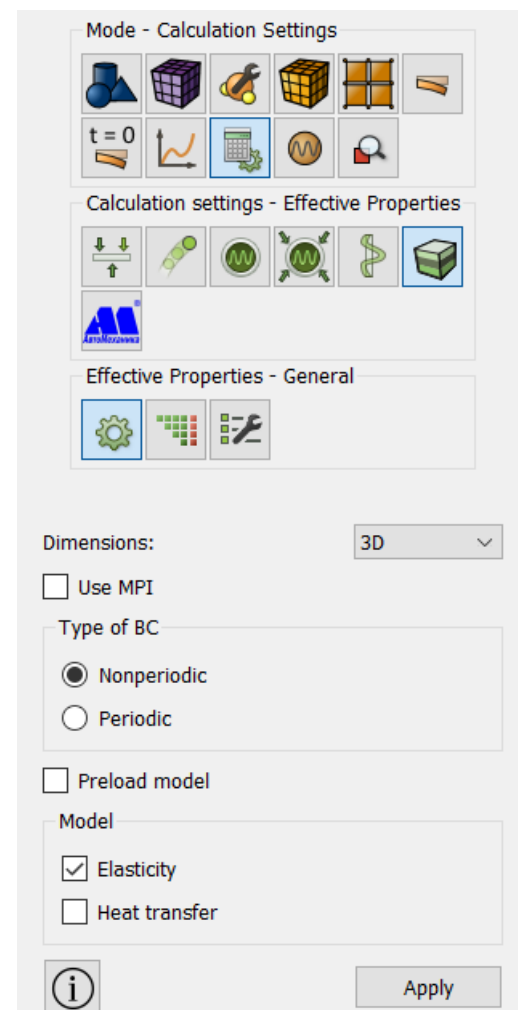

A representative volume or a periodicity cell can only consist of beam and / or shell elements (for example, in the case of calculating the effective characteristics of lattice structures, metamaterials, etc.). But in this case, it is important that the differences between the maximum and minimum coordinates of the model along all three axes (ie, its “overall dimensions”) are non-zero. If, for example, you build a rectangle in the XY plane and specify shell elements of non-zero thickness on it, the calculation of effective properties on such a model will not work, since the difference between the maximum and minimum coordinates along the Z axis is zero.

Effective Property Calculation and Its Results

CAE Fidesys supports the calculation of such effective properties as:

- 1) elasticity moduli
- 2) density
- 3) coefficients of thermal expansion
- 4) thermal conductivity coefficients.

1. Effective Elasticity Moduli

To set effective linear elastic properties calculation click "Elasticity" in the settings for calculating effective properties. To calculate effective properties the model undergoes a series of strains. The following types of strains are used:

- tension (along each of the coordinate axes);
- shears (in each of the coordinate planes).

The strain magnitude is 0.2% for all types.

Effective properties are evaluated in the form of the generalized Hook's law:

$$\sigma_{ij} = C_{ijkl} \varepsilon_{kl}$$

The result of the calculation is effective elastic modules C_{ijkl} displayed to the command line and in the file called Cijkl.txt in the working directory. The modules are evaluated in the coordinate system where the calculation was carried out (in which coordinate planes are parallel to the edges of calculation model).

Modules C_{ijkl} contain 21 independent constants – it is often more than it is necessary to describe effective properties of the tested heterogeneous material. That is why there is a possibility of the automatic conversion of the obtained effective elastic modules into constants of orthotropic, transversally isotropic or isotropic material. After completing the calculation of the effective properties, the window «Process effective properties data» opens. In the window, obtained effective elastic modules C_{ijkl} are shown at the bottom right in the form of a symmetric matrix sized 6x6 (the matrix part below the main diagonal is not displayed because of the symmetry).

If the calculated effective elastic moduli are unphysical, immediately after opening the data processing window a message will pop up, warning that the matrix is not symmetric with sufficient accuracy or is not positive definite. In this case you should check again the correct choice of model for calculation:

- if it is a rectangular parallelepiped with faces parallel to the coordinate planes
- in the two-dimensional case, if it is a rectangle with sides parallel to the coordinate axes
- if it is a periodicity cell in case of calculation with periodic boundary conditions.

If the model is correct, it is necessary to improve (grind) the grid.

When the calculation is complete, the window opens automatically. If the user closes it, it can be re-opened in the mode **Material > Effective properties:**

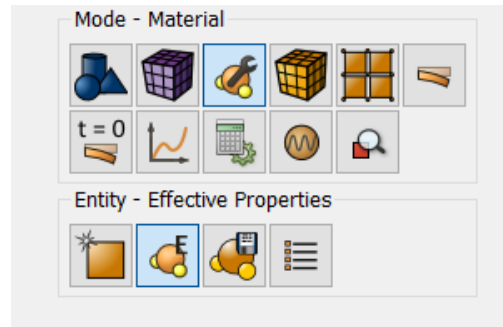

The user can assess whether the matrix with obtained C_{ijkl} corresponds to orthotropic materials with the acceptable tolerance. For the exact orthotropic material, the matrix should look as follows (where the letters X denote those components that can be nonzero).

$$\begin{pmatrix} X & X & X & 0 & 0 & 0 \\ & X & X & 0 & 0 & 0 \\ & & X & 0 & 0 & 0 \\ & & & X & 0 & 0 \\ & & & & X & 0 \\ & & & & & X \end{pmatrix}$$

Since the components of the matrix are the result of numerical calculation of effective properties - they tend to contain some errors. If, from the user's point of view, the matrix corresponds to orthotropic materials with acceptable tolerance, select the «Orthotropic» type of material and click «Process Data», and the system will calculate nine constants of orthotropic material. If the material is not orthotropic with sufficient accuracy or if orthotropic constants turned out to be unphysical, when you click "Process data" the system will show you a message with a warning.

If orthotropic constants do not depend on the direction (i.e., for example, different Young's moduli are the same or differ from each other within the acceptable error) then you can select the type of material «isotropic» and click «Process data» again. The system will calculate two constants of an isotropic material – Young's Modulus and Poisson's Ratio. If the material is not isotropic with sufficient accuracy or if Young's modulus and / or Poisson's ratio are unphysical, when you click "Process data" the system will show you a message with a warning.

2. Effective Density

Density is an additive quantity. Therefore, the effective density is calculated as the mass of the model divided by the effective volume (including pores and voids in the material). Density is calculated automatically for any calculation of effective elastic moduli.

3. Effective Coefficients of Thermal Expansion.

Calculation of effective coefficients of linear thermal expansion is set in the settings for calculating effective properties by checking the box "Thermal expansion". To calculate the effective coefficients of thermal expansion, the model is subjected to uniform heating. The heating value is 1 K.

Effective thermal expansion is estimated as:

$$\varepsilon_{ij}^{th} = \alpha_{ij} \Delta T$$

The results of the calculation are effective coefficients of thermal expansion, which are output to the command line and to a JSON file called EffProps.json located in the working directory. Coefficients are calculated in that coordinate system, in which the calculation was carried out (to the coordinate planes / axes of which the faces / sides of the calculation model are parallel).

Coefficient matrix α_{ij} contains 6 independent constants, often this is more than enough to describe the effective linear thermal expansion of the studied heterogeneous material. Therefore, it is possible to automatically recalculate obtained effective coefficients of linear thermal expansion into constants of an orthotropic or isotropic material. The window "Process data on effective properties" will appear after the calculation is completed. You may see the effective coefficients of thermal expansion α_{ij} on the "Temperature" tab on the right in the form of a symmetric matrix of thermal expansion of size 3x3 (the part of the matrix below the main diagonal is not displayed due to symmetry).

If the calculated effective thermal conductivities are unphysical, immediately after opening the data processing window, the system will show a warning that the matrix α_{ij} is not symmetric with sufficient accuracy or is not positively definite. In this case you should check again the correct choice of model for calculation:

- if it is a rectangular parallelepiped with faces parallel to the coordinate planes
- in the two-dimensional case, if it is a rectangle with sides parallel to the coordinate axes
- if it is a periodicity cell in case of calculation with periodic boundary conditions.

If the model is correct, it is necessary to improve (grind) the grid.

The user can assess whether the matrix with obtained α_{ij} corresponds to orthotropic materials with the acceptable tolerance. For the exact orthotropic material, the matrix should look as follows (where the letters X denote those components that can be nonzero).

$$\begin{pmatrix} X & 0 & 0 \\ & X & 0 \\ & & X \end{pmatrix}$$

Since the components of the matrix are the result of numerical calculation of effective properties - they tend to contain some errors. If, from the user's point of view, the matrix corresponds to orthotropic materials with acceptable tolerance, select the «Orthotropic» type of material and click «Process Data», and the system will calculate nine constants of orthotropic material. If the material is not orthotropic with sufficient accuracy or if orthotropic constants turned out to be unphysical, when you click "Process data" the system will show you a message with a warning.

If orthotropic constants do not depend on the direction (i.e., for example, different Young's moduli are the same or differ from each other within the acceptable error) then you can select the type of material «isotropic» and click «Process data» again. The system will calculate two constants of an isotropic material – Young's Modulus and Poisson's Ratio. If the material is not isotropic with sufficient accuracy or if Young's modulus and / or Poisson's ratio are unphysical, when you click "Process data" the system will show you a message with a warning.

4. Effective Biot Coefficients

The calculation of the effective Biot coefficients is set in the settings for calculating the effective properties by checking the Poroelasticity checkbox. To calculate the effective Biot coefficients, fixing boundary conditions are imposed on the outer boundary of the model (i.e., not allowing its deformation). All internal surfaces are subjected to the same pressure.

The effective poroelasticity of a material is estimated in the form of the Biot-Terzaghi law:

$$\sigma_{ij} = C_{ijkl} \varepsilon_{kl} - \beta_{ij} p I$$

The result of the calculation is the effective Biot β_{ij} coefficients output to a JSON file named EffProps.json located in the working directory. The coefficients are calculated in the coordinate system in which the calculation was performed (the coordinate planes/axes of which are parallel to the faces/sides of the calculation model).

The matrix of coefficients β_{ij} contains 6 independent constants, which is often more than enough to describe the effective poroelasticity of the investigated inhomogeneous material containing pores. Therefore, it is possible to

automatically recalculate the obtained effective Biot coefficients into the constants of an orthotropic or isotropic material. When the calculation is completed, the "Process Effective Properties Data" window also appears. The effective Biot coefficients β_{ij} are shown on the Poroelasticity tab on the right as a symmetrical 3x3 poroelasticity matrix (the portion of the matrix below the main diagonal is not displayed due to symmetry).

If the calculated effective combat coefficients are not physical, immediately after opening the data processing window, a window appears with a corresponding warning about the matrix β_{ij} asymmetry with sufficient accuracy. In this case, one should once again check the correctness of the choice of the model for calculation: whether it is a rectangular parallelepiped with faces parallel to the coordinate planes (in the two-dimensional case, a rectangle with sides parallel to the coordinate axes), and whether it is a periodicity cell in the case of calculation with periodic boundary conditions. If the model is built correctly, it is likely that the mesh needs to be improved (refine).

The user can evaluate whether the matrix corresponds to the received β_{ij} orthotropic material with the accuracy that satisfies him. For an exact orthotropic material, this matrix should look like this (here X denotes those components that can be non-zero).

$$\begin{pmatrix} X & 0 & 0 \\ & X & 0 \\ & & X \end{pmatrix}$$

But, since the matrix components are the result of a numerical calculation of the effective properties, they usually contain some error. If, from the user's point of view, the matrix corresponds to an orthotropic material with acceptable accuracy, you can select the poroelastic property type "Orthotropic" and click the "Process Data" button, which will calculate the three orthotropic material constants. If the material is not orthotropic with sufficient accuracy, or if the Biot orthotropic coefficients are found to be non-physical, pressing the "Process data" button will open a window with a corresponding warning.

If the orthotropic constants do not depend on the direction (different Biot coefficients are the same or differ from each other within the acceptable error), then you can select the material type "Isotropic" and click the "Process data" button again. One constant will be calculated - the isotropic coefficient of the Biomaterial. If the material is not isotropic with sufficient accuracy, pressing the "Process data" button will open a window with a corresponding warning.

5. Effective Thermal Conductivity.

To set the calculation of the effective thermal conductivity tick "Thermal conductivity" in the settings for calculating the effective properties. To calculate the effective thermal conductivity coefficients, the model undergoes a series of heatings: the system sets different temperatures corresponding to a certain temperature gradient in the model on its faces. The system uses gradients directed along each coordinate axis. The effective thermal conductivity of the material is estimated in the form of the Fourier law of thermal conductivity:

$$q_i = -\lambda_{ij} (\nabla T)_j$$

The result of the calculation is the effective thermal conductivity coefficients λ_{ij} , output to the command line and to a JSON file with the name EffProps.json located in the working directory. The program calculates the coefficients in the coordinate system in which the calculation was carried out (to the coordinate planes / axes of which the faces / sides of the calculation model are parallel).

The coefficient matrix λ_{ij} contains 6 independent constants. Often this is more than enough to describe the effective linear thermal conductivity of the studied inhomogeneous material. Therefore, it is possible to automatically convert the obtained effective coefficients of linear thermal conductivity to the constants of an orthotropic or isotropic material. After the calculation is completed, the "Process data by effective properties" window also appears. Temperature tab, bottom right,

shows effective thermal conductivity λ_{ij} coefficients in the form of a symmetric thermal conductivity matrix of size 3x3 (a part of the matrix below the main diagonal is not displayed due to symmetry).

If the calculated effective thermal conductivities are unphysical, immediately after opening the data processing window, the system will show a warning that the matrix λ_{ij} is not symmetric with sufficient accuracy or is not positively definite. In this case you should check again the correct choice of model for calculation:

- if it is a rectangular parallelepiped with faces parallel to the coordinate planes
- in the two-dimensional case, if it is a rectangle with sides parallel to the coordinate axes
- if it is a periodicity cell in case of calculation with periodic boundary conditions.

If the model is correct, it is necessary to improve (grind) the grid.

The user can assess whether the matrix with obtained λ_{ij} corresponds to orthotropic materials with the acceptable tolerance. For the exact orthotropic material, the matrix should look as follows (where the letters X denote those components that can be nonzero).

$$\begin{pmatrix} X & 0 & 0 \\ & X & 0 \\ & & X \end{pmatrix}$$

Since the components of the matrix are the result of numerical calculation of effective properties - they tend to contain some errors. If, from the user's point of view, the matrix corresponds to orthotropic materials with acceptable tolerance, select the «Orthotropic» type of material and click «Process Data», and the system will calculate nine constants of orthotropic material. If the material is not orthotropic with sufficient accuracy or if orthotropic constants turned out to be unphysical, when you click "Process data" the system will show you a message with a warning.

If orthotropic constants do not depend on the direction (different coefficients of thermal conductivity are the same or differ from each other within the acceptable error) then you can select the type of material "Isotropic" and click "Process Data" again. The system will calculate one constant - isotropic coefficient of linear thermal conductivity of the material. If the material is not isotropic with sufficient accuracy, when you click "Process data" the system will show you a message with a warning.

The calculation of the effective thermal conductivity of an inhomogeneous material can be carried out separately or together with calculations of effective elastic properties (in the second case, in the calculation settings it is necessary to tick the checkboxes "Elasticity" and "Thermal conductivity"). If the thermal expansion coefficients of at least one material in the model are specified in the joint calculation, the effective moduli of elasticity, the effective coefficients of thermal expansion, and the effective coefficients of thermal conductivity will be calculated. In the window for processing results, both thermal conductivity coefficients and thermal expansion coefficients are located on the "Temperature" tab.

Processing Results and Exporting Effective Material

The picture below shows the window exterior «Process effective properties data».

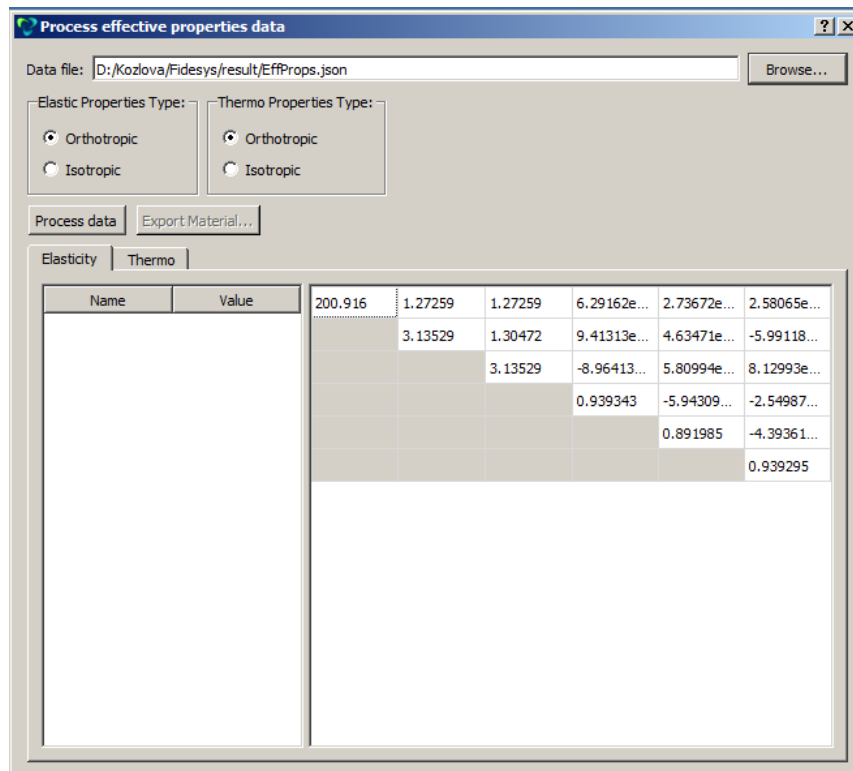

If the processed material constants satisfy the user, the option to export the material into the file XML is available in the same window. You need to select a name for the effective material and the name of the XML file into which it will be exported. When you click «Export Material», the system first creates the material with the name entered and with the obtained effective properties. Then all materials created during the calculation are exported to an XML file with the entered name. You can import these materials from the created file.

If a heterogeneous material, the efficient properties of which are investigated, is orthotropic or isotropic for empirical reasons and the calculation results do not correspond to that – you should try to refine the mesh or to choose a model for calculation differently.

SEG-Y Format

SEG-Y is a sequential trail format designed for storing fully or partially processed seismic data.

<https://en.wikipedia.org/wiki/SEG-Y>

To record the selected calculation results in the SEG-Y format, it is necessary to place the Receivers on the model in the preprocessor (**Command Panel, Mode - Receivers, Operation - Create**).

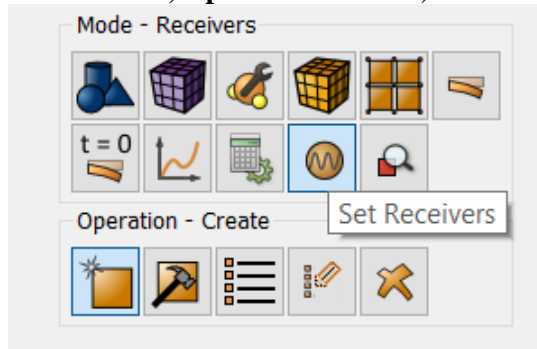

Select from the drop-down list the geometric entities that will be receivers.

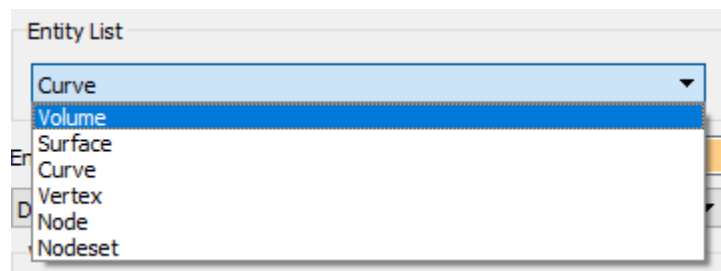

Specify which data fields to save in SEG-Y format.



Installed receiver lines are displayed in the Tree on the left in the Results Settings section.

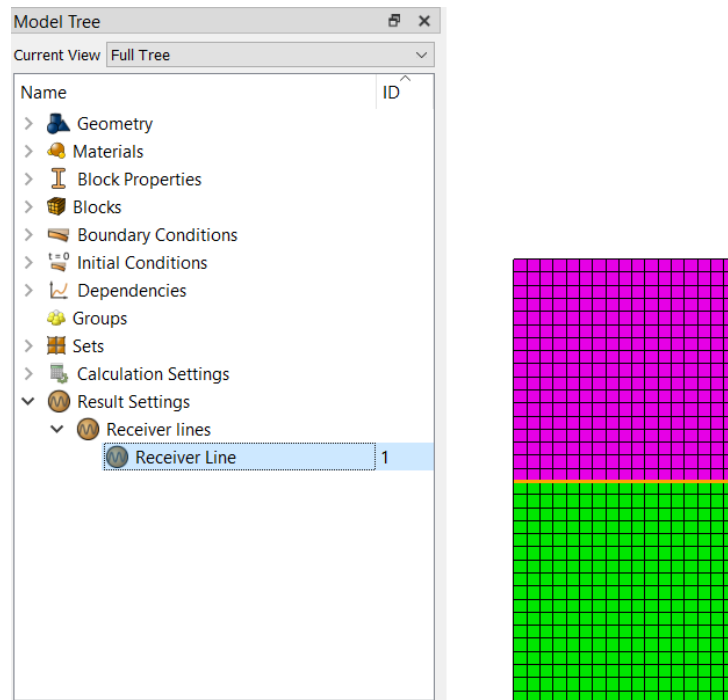

Viewing data in SEG-Y format is possible in the *CAE Fidesys* Viewer postprocessor, and you need to open the file with the .sgy extension.

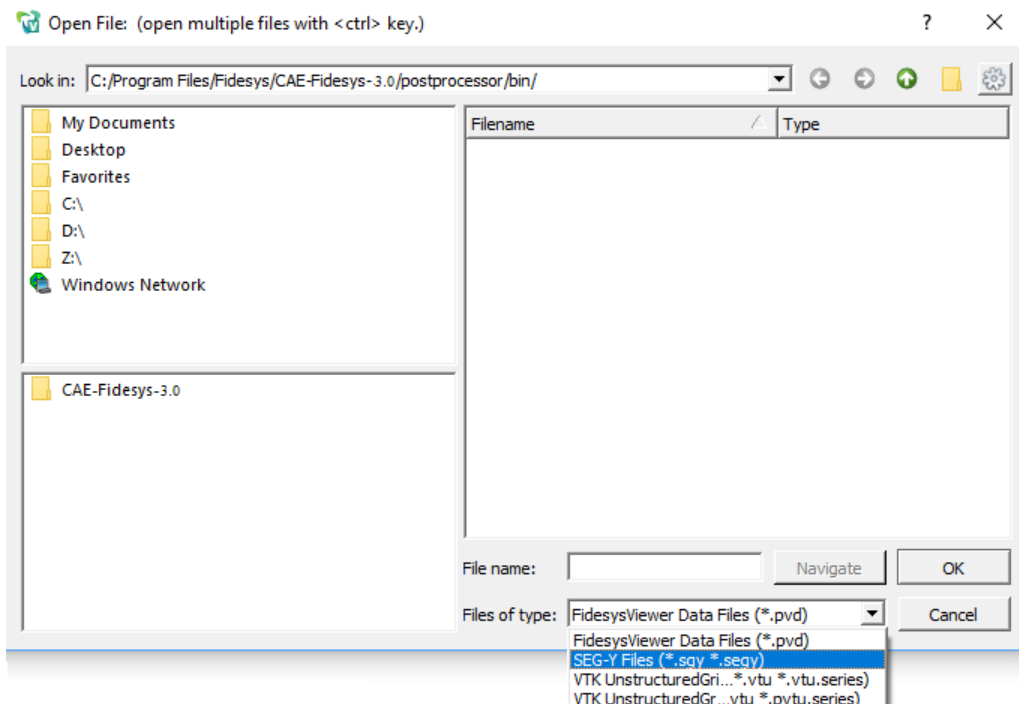

In Fidesys Viewer it is possible to select the required subregions of the model using the Slice / Clip filters (**Menu - Filters - Alphabetical Index - Slice**)

[An example of the resulting SEG-Y file](#) for V_y speed in CAE Fidesys:



Features of writing data to the *.sgy file

- All data in the file header, with the exception of the results themselves, are written in integer form.
- The time step (recording step) is recorded in microseconds.
- The coordinates of the receiver are recorded in meters (If the distance between receivers is less than one meter, then the coordinates of the paths may coincide, and the wave pattern may be incorrect).
- Inline number coincides with the id of the node in which it is specified, the Crossline number matches the line number of the receivers.

Spectral Method for Solving Linear Dynamic Problems Using the Response Spectrum (response spectrum, reaction spectrum)

Modal Analysis

Calculation using the response spectrum is based on modal analysis. Before starting the calculation of natural frequencies and vibration modes, go to the tab Calculation settings – Modal Frequency analysis - Output field and check the Evaluate effective masses.

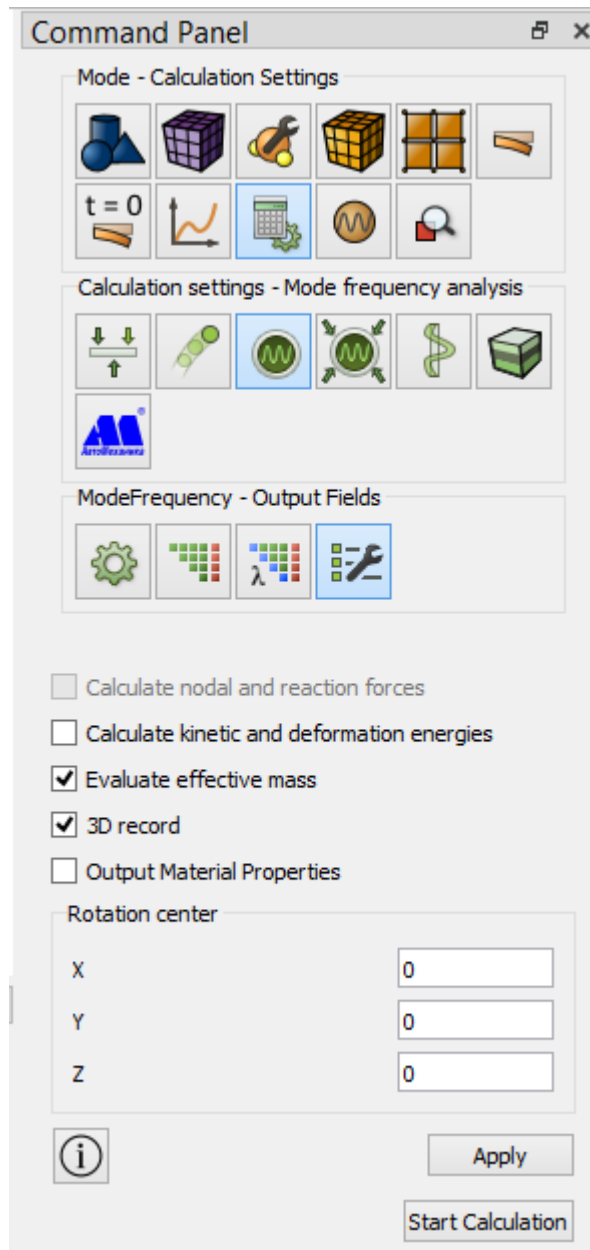

Next, start the calculation and go to Fidesys Viewer.

Response Spectrum Setting

The response spectrum is set in the Fidesys Viewer program. In the main menu, go to Filters - Index – Modal Combinations. The following settings are available in the appeared window of properties of calculation results:

1. The choice of the combination method of the mods Absolute sum, Square root of sum of squares, Complete quadratic combination;
2. Setting the value of the modal damping coefficient Mode Damping Ratio;
3. The way to set the response spectrum of the Dependency Type (CSV File - assignment via the csv format table, Formula - assignment through the formula);

If you select CSV File in step 3, then CSV File - the path of the csv file is selected; if you select Formula in step 3, then Calc Function is the task of the function in which the argument is the natural frequency;

Field Info spectral curve selection - displacement, speed, acceleration.

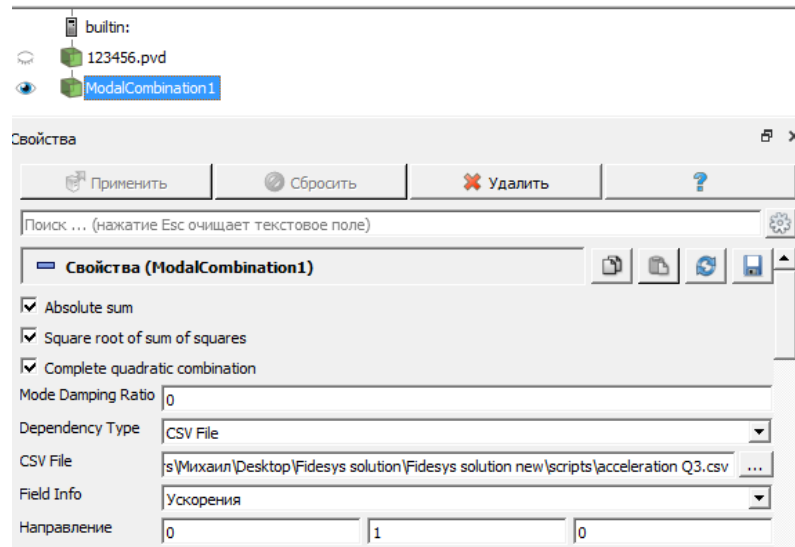

After all the settings, click Apply.

Further, it is possible to open the necessary result plots (for example, displacements obtained by the SRSS method will be available under the name Displacement_SRSS).

Additive Printering

Additive manufacturing is a technology for creating products, which is based on the gradual “building up” of material on a base in the form of a flat platform or axial frame.

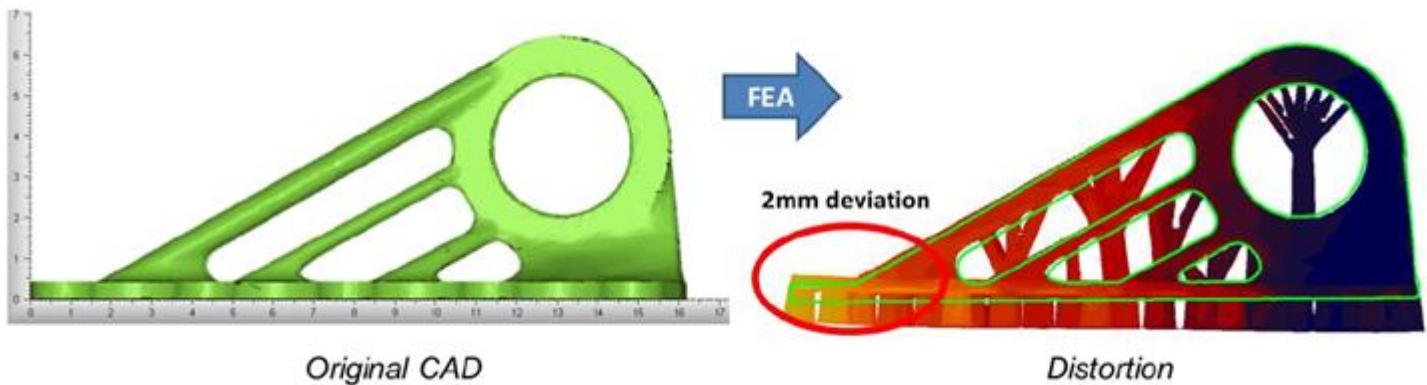

Mathematical modeling of the additive manufacturing process is an important preparatory step in determining the strategy for manufacturing a part. The importance of this stage is primarily justified by the fact that during the production process, the shape of the object may be distorted due to the peculiarities of the technology, which can lead to going beyond the limits of dimensional tolerances or displacement of functional areas.

Voxel Mesh and BCs

For this calculation, a voxel mesh must be built on the model. CAE Fidesys uses the voxelmesh command for this. When using this command, a block is created for each layer, to which you later need to assign a material.

To set boundary conditions when simulating additive printing in CAE Fidesys, you must use the boundary condition Additive printing:

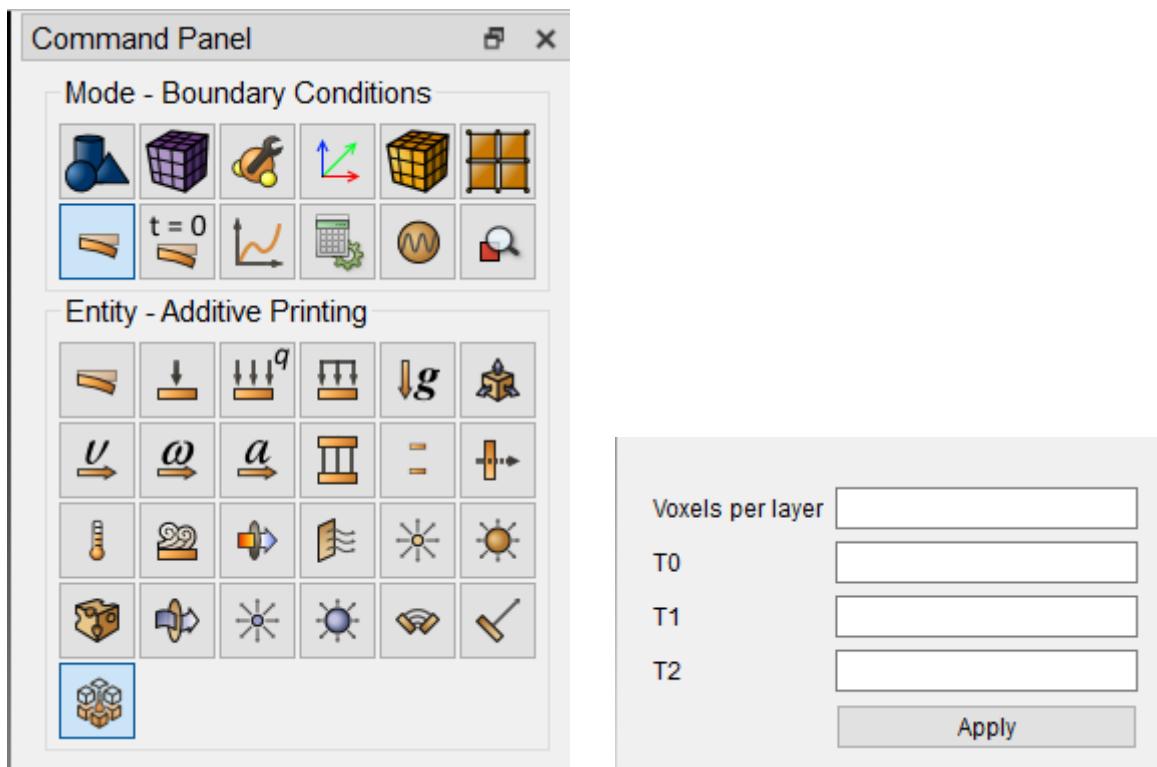

You can also use the voxelbc command.

voxelbc L <value> t0 <value> t1 <value> t2 <value>

L (voxel per layer) - the number of layers added to the calculation in one step (or layer thickness in voxels);

T0 - base (substrate) temperature;

T1 is the temperature of the newly created layer;

T2 - to what temperature the lower layer cools down at the moment of joining the upper one.

Additionally, the voxelbc command:

- sets the fixation in all degrees of freedom on the lower layer;
- sets the number of steps for stepwise calculation ($1+(2*\text{total number of voxel layers}/L)$)

If necessary, changing/disabling blocks is done manually.

Note: For the alpha version of the analysis, blocks and boundary conditions on steps are controlled through the static analysis settings (Set number of loading steps option). The calculation is launched directly from the Calculation Settings - Additive Printing section. In addition, the model must be modified so that the layers grow in the Z direction.

Starting Calculation

The calculation is started from the static analysis with the Additive Manufactured option (Command Panel - Calculation Settings - Static Analysis).

Specify on the command line for static calculation:

- Dimention
- Model: elasticity, thermal conductivity, additive printing, geometric non-linearity (if necessary).
- Number of loading steps

Click "Apply", "Start Calculation".

The command to run on the calculation of additive printing:

```
analysis type static elasticity heattrans slm findefs slm dim3  
calculation path "D:/calc/path_to_file.pvd"
```

You must insert the path to the *.pvd calculation file into the calculation path command.

Modeling example for additive printing.

1. To construct a voxel mesh, voxel sizes $x=y=z=0.25$ are used. The model was also scaled in meters. And moved so that the layers grow along the Z axis. The result:

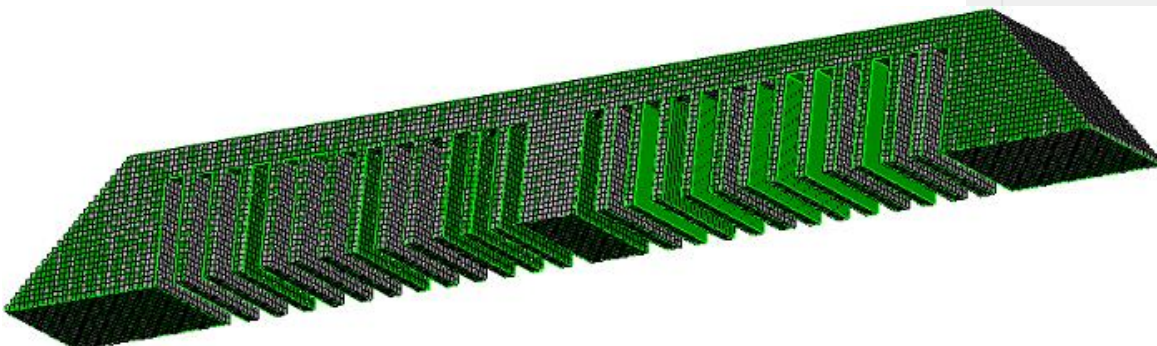
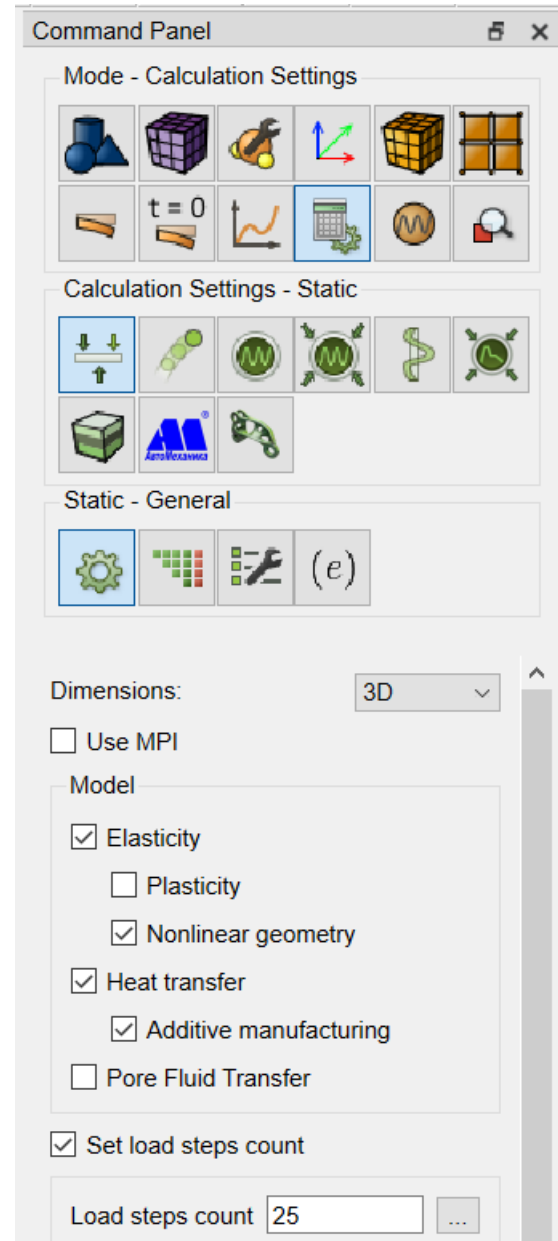

At the same stage, 24 blocks were created (can be checked in the Tree or using the list block all command).

2. You must define a material and assign it to blocks (for example, using the block all material 1 command) or via the GUI.

3. Boundary condition is used Additive printing with parameters:

- Voxels per layer: 1;
- $T_0=100$ $T_1=1300$ $T_2=500$.

Thus, one layer is built up in one step ($L=1$). The total number of steps in step-by-step solution becomes 49. This is ($2*24+1$).

4. Next, a boundary condition is manually added at the last step (fixing the middle of the cut layer) and the order of removing blocks is corrected.

Fastening in the last step simulates cutting off the “legs”. In order not to reassign the automatically created blocks, the faces of the hexahedra are fixed in the middle of the cut layer.

The result of the solution at the last step in the postprocessor (deformed view):

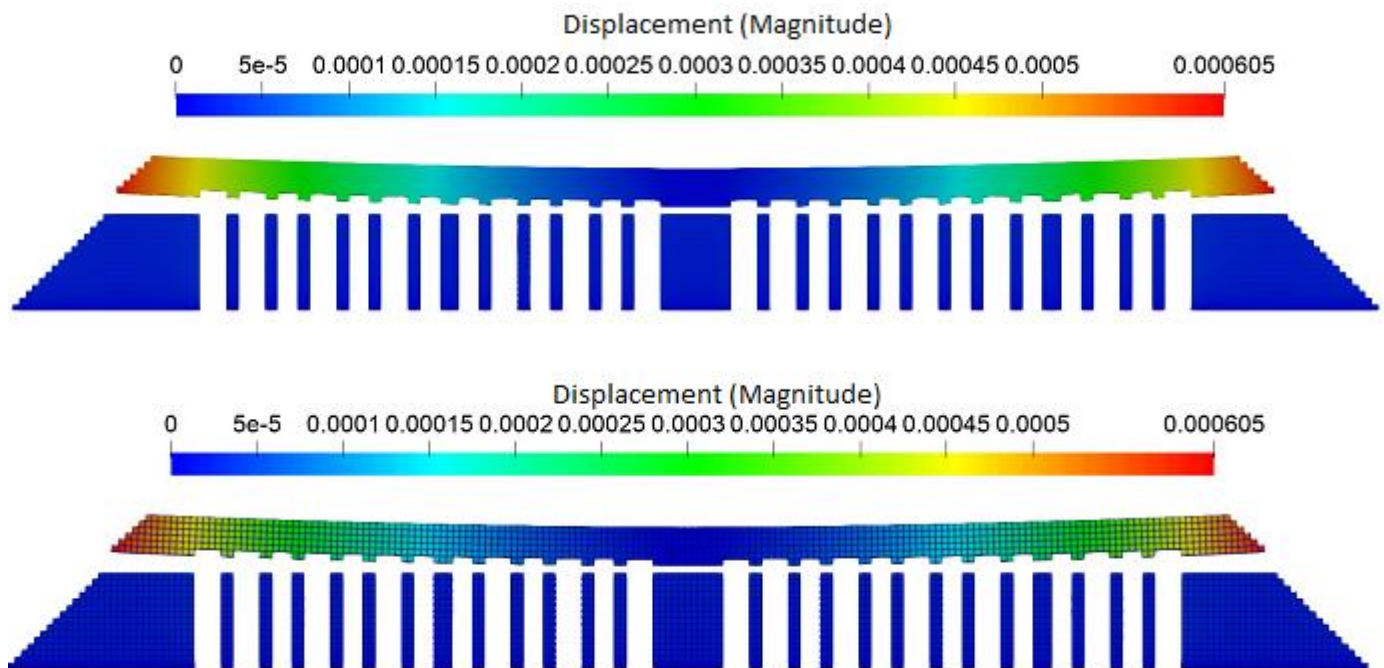

Results Visualization and Postprocessing

About Fidesys Viewer Software

The *Fidesys Viewer* software is used for visualization and analysis of the obtained results:

- Visualization of vector and tensor fields;
- Graph;
- Time dependency analysis;
- SEG-Y files.

You don't need to install *Fidesys Viewer* individually as it is included into the *CAE Fidesys* package. You don't need a license to use *Fidesys Viewer*: the results of calculations obtained by using the *CAE Fidesys* preprocessor are available for viewing in *Fidesys Viewer* even after the license expires.

Main Window

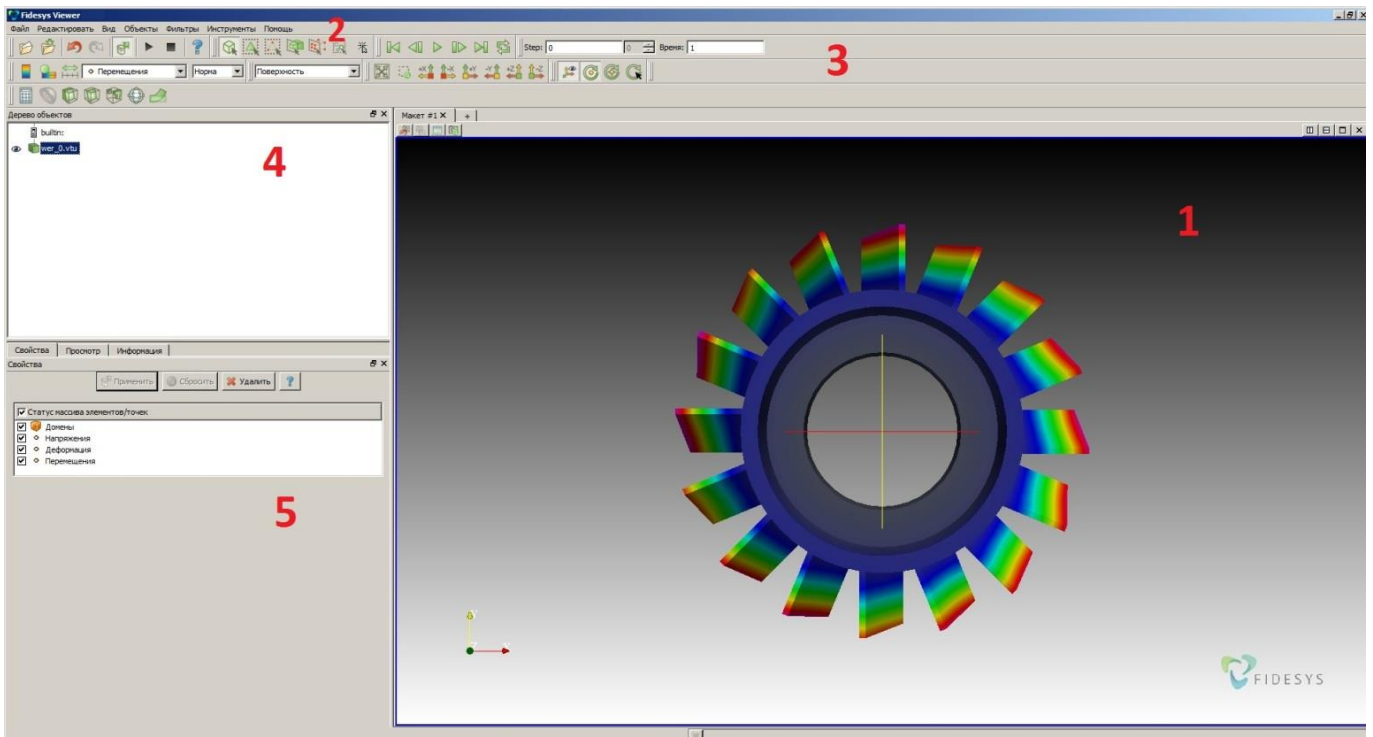

Workbench (1) displays the model and visual effects.

Main Menu (2) includes standard operations for working with files and projects, managing the visualization modes, panel display settings, filters, tools, and help available in the drop-down lists of the menu.

Toolbar (3) comprises the buttons for calling the most frequently used commands while working with the program.

Pipeline Browser (4) includes the opened models and filters applied to them.

Properties Page (5) displays the properties of the selected object in the Workbench or in the Pipeline Browser.

You can show or hide additional panels in the menu **View**.

Basics of the Program

Fidesys Viewer allows you to view and analyze the results. You can do that using multiple filters selected in the item **View** in the menu. Some of them are described below.

Display on the data field and legend model

Fields and components of display can be selected in the Toolbar:

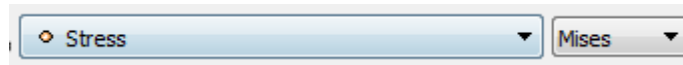

You can also see the Color Map by clicking  in the Toolbar.

Selection

In order to select points or cells, use the following buttons in the Toolbar:



On-screen information display

Numerical results for the data fields can be viewed in the tab **Information**. If the entire model is in focus, the fields of the tab **Information** contain a range of data – from minimum to maximum value.

The values in points can be found using the filter Probe Location (**Filters** → **Alphabetical** → **Probe Location**). Then you need to specify the viewing point coordinates. After applying the filter, data field values are displayed only for the specified point in the tab **Information**.



It is also possible to view the numerical results for the selected points by clicking **Point Information** on the Toolbar.

The values in the points/nodes/elements can be identified and viewed by using **Selection Inspector** (**View** → **Selection Inspector**).

Overview of the strained model

To view the strained model, select **Filters** → **Alphabetical** → **Warp By Vector**. In the Properties tab, you can select the display scale.



To quickly access the filter, click **Warp By Vector** on the top panel.

Spherical/cylindrical coordinate systems

To receive data from the spherical or cylindrical coordinate systems, select **Filters** → **Alphabetical** → **Coordinate systems**. Next, select the data field that you want to represent in new coordinates. After applying the filter, a new data field will appear in the tab Information, for example, Stress (spher.).

Graphing along straight line

To graph along a straight line, select **Filters** → **Alphabetical** → **Graph along a straight line**.

Specify coordinates of the beginning and end of the line. In the tab **View**, select the appropriate data field to display in the graph.

Graphing along curves

To graph along a curve, select nodes (see par. Selection) for which graph will be plotted. Next, use **Filters** → **Alphabetical** → **Extract selected** and then **Filters** → **Alphabetical** → **Show data**.

Graphing in time dependency

To plot a time dependency graph, you should allocate points of interest through the Allocation Inspector or by the button **Select points** in the standard string and then apply the filter **Filters** → **Alphabetical** → **Plot selection over time**.

Estimation of the mesh quality

To estimate the mesh quality, select **View** → **Filters** → **Alphabetical** → **Mesh Quality**. Specify the necessary settings in the tab **Properties**. After applying the filter, new fields will appear based on the analysis of which we can draw conclusions about the quality of the resulting mesh.

Slice

To view the model slice, select **Filters** → **Alphabetical** → **Slice**. Specify the normal or the direction in which you want to make the slice.

Cross section

To view the model cross section, select **Filters** → **Alphabetical** → **Cross section**. Specify the normal or the direction in which you want to make the slice.

Beam and shell 3D-display



To view beams and shells in 3D in the *Fidesys Viewer* postprocessor, you can click on the button **3D** in the standard string.

Margin of Safety

To view the model cross section, select **Filters** → **Alphabetical** → **Margin Of Safety**. If the ultimate strength and yield strength were not specified when preprocessing, you should set them in the tab **Properties**. Margin of safety is calculated by the first theory of strength, energy theory, Tresca theory, Mohr's theory of failure, Pisarenko-Lebedev theory. Obtained values can be viewed in the tab **Information** in the new field **Margin Of Safety**. The first component of the field is the margin of safety by the first theory of strength; the second is the margin of safety by the energy theory, etc.

Formulas for Strength Criteria

σ_t — uniaxial tensile strength;

σ_c — uniaxial compression strength;

σ_m — tension von Mises;

c — soil cohesion;

φ — angle of friction;

σ_1 — first major stress;

σ_2 — second major stress;

σ_3 — third major stress;

n — the field of the margin of safety that needs to be displayed.

1. Calculation according to the first theory of strength.

It is used in the assumption of brittle fracture. By contours σ_1 contours of safety factors are built $n = \sigma_t / \sigma_1$

2. Calculation according to the energy theory of strength (Mises stress).

It is used in the assumption of viscous fracture or if plastic state is not allowed.

By contours σ_i isolines of safety factors are built $n = \sigma_y / \sigma_m$ or $n = \sigma_{0,2} / \sigma_m$, where σ_y or $\sigma_{0,2}$ — physical or conditional yield strength.

3. Calculation according to the Pisarenko-Lebedev theory.

It is used in mixed fracture.

By fields σ_m and σ_1 contours of safety factors are built

$$n = \frac{\sigma_t}{\chi\sigma_m + (1 - \chi)\sigma_1}, \text{ where}$$

$$\chi = \frac{\sigma_t}{\sigma_c}.$$

4. Calculation according to the Mohr's theory, mixed destruction.

Contours of the margin of safety

$$n = \frac{\sigma_t}{\sigma_1 - \chi\sigma_3} = \frac{\sigma_t\sigma_c}{\sigma_c\sigma_1 - \sigma_t\sigma_3}.$$

5. The third theory of strength by Tresk, viscous destruction or prevention of plastic flow.

A special case from Mohr's theory for

$$\chi = 1. n = \frac{\sigma_t}{\sigma_1 - \sigma_3}.$$

6. Mohr-Coulomb Criterion

$$\tau_{max} = A + B\sigma_n$$

$$\tau_{max} = \frac{1}{2}(\sigma_1 - \sigma_3) \cos \phi$$

$$\sigma_n = \frac{\sigma_1 + \sigma_3}{2} + \frac{\sigma_1 - \sigma_3}{2} \sin \phi$$

- normal stress on the fracture plane

$$A = c; B = - \tan \phi$$

or

If strength limits are specified σ_c and σ_t , then

$$\phi = \arcsin\left(-\frac{b}{a}\right),$$

$$c = \frac{\sqrt{\sigma_c \sigma_t}}{2}$$

where

$$a = \sigma_t + \sigma_c;$$

$$b = \sigma_t - \sigma_c < 0 \text{ (with } b > 0 \text{ the angle of internal friction becomes negative, which is unacceptable)}$$

Margin of safety:

$$n = \frac{A}{\tau_{max} - B \sigma_n}$$

7. Mogi-Coulomb Criterion

$$\tau_{oct} = A + B \sigma_{m,2} \cdot \text{rde}$$

$$\tau_{oct} = \frac{1}{3} \sqrt{(\sigma_1 - \sigma_2)^2 + (\sigma_2 - \sigma_3)^2 + (\sigma_3 - \sigma_1)^2}$$

$$\sigma_{m,2} = \frac{(\sigma_1 + \sigma_3)}{2}$$

$$A = \frac{2 \sqrt{2}}{3} c; \quad B = -\frac{2 \sqrt{2}}{3} \tan \phi$$

or

$$A = \frac{2 \sqrt{2}}{3} \frac{\sigma_c \sigma_t}{\sigma_c + \sigma_t}; \quad B = \frac{2 \sqrt{2}}{3} \frac{\sigma_t - \sigma_c}{\sigma_c + \sigma_t};$$

Safety factor

$$n = \frac{A}{\tau_{oct} - B \sigma_{m,2}}$$

8. Drucker-Prager criterion

$$\frac{\sigma_m}{\sqrt{3}} = A + B (\sigma_1 + \sigma_2 + \sigma_3)$$

$$\sqrt{\frac{1}{6} [(\sigma_1 - \sigma_2)^2 + (\sigma_2 - \sigma_3)^2 + (\sigma_3 - \sigma_1)^2]} > A + B (\sigma_1 + \sigma_2 + \sigma_3) \cdot \text{rde}$$

$$A = \frac{2}{\sqrt{3}} \left(\frac{\sigma_c \sigma_t}{\sigma_c + \sigma_t} \right); \quad B = \frac{1}{\sqrt{3}} \left(\frac{\sigma_t - \sigma_c}{\sigma_c + \sigma_t} \right) \cdot$$

or

$$A = \frac{6c \cos \phi}{\sqrt{3}(3 - \sin \phi)}; \quad B = \frac{-2 \sin \phi}{\sqrt{3}(3 - \sin \phi)}$$

Safety margin:

$$n = \frac{A}{\frac{\sigma_m}{\sqrt{3}} - B (\sigma_1 + \sigma_2 + \sigma_3)} = \frac{A}{\sqrt{\frac{1}{6} [(\sigma_1 - \sigma_2)^2 + (\sigma_2 - \sigma_3)^2 + (\sigma_3 - \sigma_1)^2]} - B (\sigma_1 + \sigma_2 + \sigma_3)}$$

This criterion was developed to describe the plastic deformation of clay soils. You can also use it to describe the destruction of rocky soils, concrete, polymers, foam and other pressure-dependent materials.

9. Navier criterion

Another name for the Mohr-Coulomb criterion

$$\tau = A + B\sigma_n$$
$$\sigma_n = \frac{\sigma_1 + \sigma_3}{2} + \frac{\sigma_1 - \sigma_3}{2} \sin \phi \quad \text{- the normal stress at failure;}$$

$$A = c; B = -\tan\phi;$$

The minus is due to the fact that compression should lead to hardening, and compression σ_n corresponds to negative values $c = -\tau_B$ - tensile strength (shear), which is entered by the user for each material, or cohesion;

$$n = \frac{\tau_B}{-B \frac{\sigma_1 + \sigma_3}{2} + \frac{\sigma_1 - \sigma_3}{2} \sqrt{B^2 + 1}}$$

10. Hoek – Brown criterion

Hook-Brown criterion has the form:

$$\sigma_1 = \sigma_3 + \sqrt{A\sigma_3 + B^2},$$

where A, B are constants depending on the material.

Using the average normal stress (σ_{mean}) and maximum shear stress (τ_{max}), we get:

$$\tau_{max} = \frac{1}{2} \sqrt{A(\sigma_{mean} - \tau_{max}) + B^2},$$

Where

$$\tau_{max} = \frac{1}{2}(\sigma_1 - \sigma_3), \quad \sigma_{mean} = \frac{1}{2}(\sigma_1 + \sigma_3).$$

The resulting expression can be transformed to a form similar to the Mohr-Coulomb criterion, resolving it with respect to τ_{max} :

$$\tau_{max} = \frac{1}{8} \left[-A \pm \sqrt{A^2 + 16(A\sigma_{mean} + B^2)} \right]$$

Constants A and B, depending on the material, are related to the ultimate strength in uniaxial tension (σ_t) and ultimate strength in uniaxial compression (σ_c) by the following relationships:

$$A = \frac{\sigma_c^2 - \sigma_t^2}{\sigma_t}, \quad B = \sigma_c.$$

Margin of safety:

$$n = \frac{-8\tau_{max} \pm \sqrt{A^2 + 16(A\sigma_{mean} + B^2)}}{A}.$$

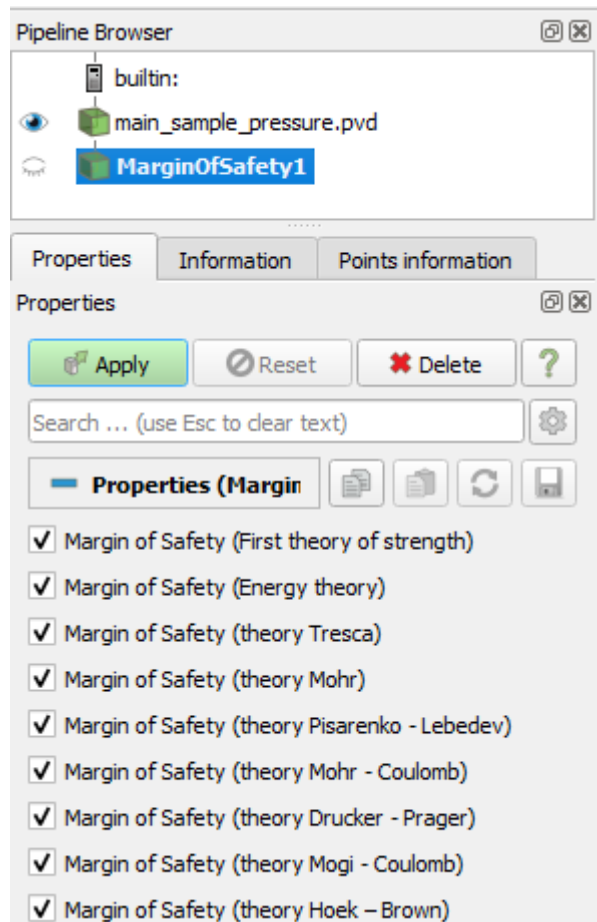



Harmonic analysis

To plot the frequency dependencies after performing a calculation using harmonic analysis, select **Filters** → **Index** → **Harmonic Analysis**. Specify the node number, the characteristics of which will be presented on the graph.

Data saving

To get numerical values of the obtained results, save the data in .csv format. To do it Click **Ctrl+S** or select **File** → **Save**. The saved file is an ordinary table of numerical data which can be opened in any text editor.

For dynamic problems, saving the model variation under deformation is available. To do it Select **File** → **Save Animation**.

Step-by-Step User Guide

Solving any problem using **CAE FIDESYS** package includes 6 basic steps:

- Model generating
- Meshing
- Setting boundary conditions
- Setting the material
- Starting calculation
- Results analysis

See some examples with step-by-step guide below.

Static Analysis (3D)

NAFEMS test “Thick Plate Pressure”, Test No LE10, Date/Issue 1990-06-15/2.

The problem of static load of a plate is being solved.

The pictures below represent a geometric model of the problem:

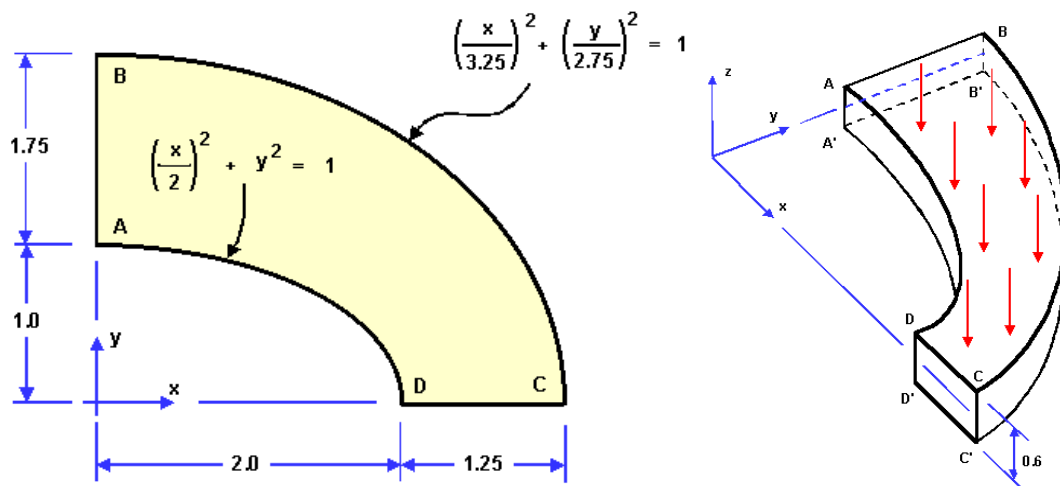

Displacements along the normal to the sides are constrained in the side slices of the plate. All of the points of the outer curvilinear surface are fixed in the XY plane. The outer curvilinear surface is fixed along the middle line of displacements along Z axis. The pressure to the upper side is 1 MPa. The material parameters are $E = 210 \text{ hPa}$, $\nu = 0.3$.

Test pass criterion is the following: stress σ_{yy} at the point D is -5.38 MPa to within 3%.

Geometry Creation

1. Create the first elliptic cylinder.

Select volume geometry generation section on Command Panel (Mode — **Geometry**, Entity — **Volume**, Action — **Create**).

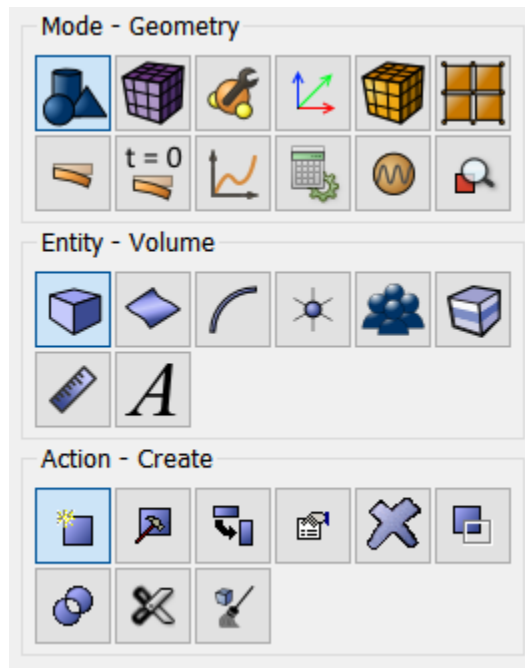

Select **Cylinder** in the list of geometric elements. Specify the cylinder dimensions:

- Height: 0.6;
- Cross Section: Elliptical;
- Major Radius: 2;
- Minor Radius: 1.

Click **Apply**.

2. Create the second elliptic cylinder.

Select volume geometry generation section on Command Panel (Mode — **Geometry**, Entity — **Volume**, Action — **Create**). Select **Cylinder** in the list of geometric elements. Specify the cylinder dimensions:

- Height: 0.6;
- Cross Section: Elliptical;
- Major Radius: 3.25;
- Minor Radius: 2.75.

Click **Apply**.

As a result, two generated entities are displayed in the Model Tree (Volume 1 and Volume 2):

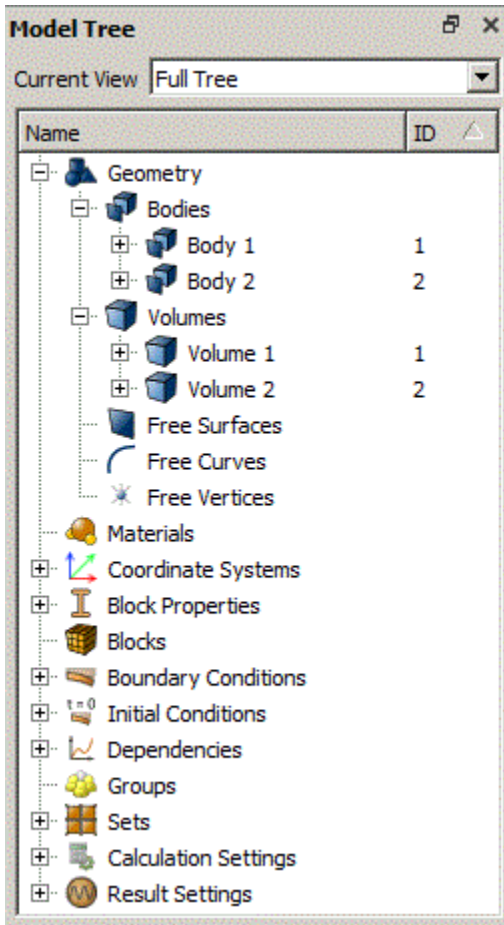

3. Subtract the first cylinder from the second one .

Select volume geometry generation section on Command Panel (Mode — **Geometry**, Entity — **Volume**, Action — **Boolean**).

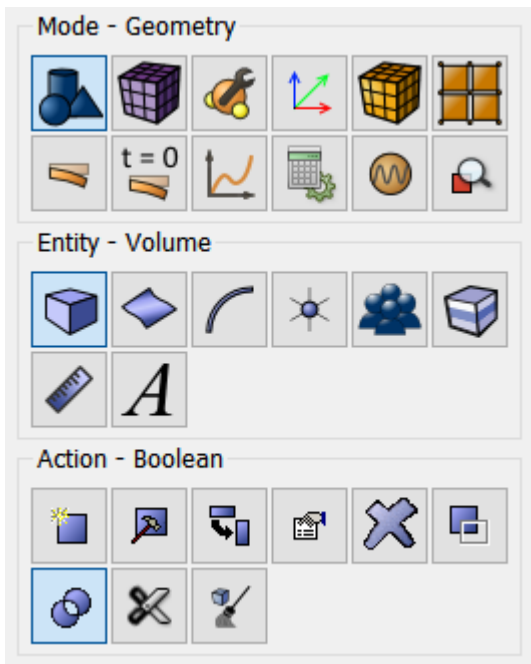

Select **Subtract** in the list of operations. Set the following parameters:

- A Volume ID(s): 1 (*the volumes to be subtracted*);
- B Volume ID(s): 2 (*volumes from which other volumes will be subtracted*);
- Imprint.

Click **Apply**.

As a result, only one volume is displayed in the Model Tree (Volume 2).

4. Leave a quarter of a volume (symmetry of the problem).

Select volume geometry generation section on Command Panel (Mode — **Geometry**, Entity — **Volume**, Action — **Webcut**).

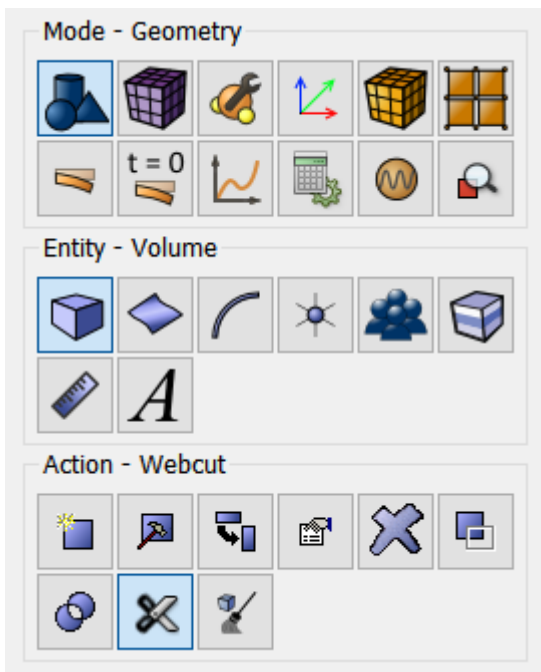

Select **Coordinate Plane** in the list of possible webcut types. Set the following parameters:

- Volume ID(s): 2 (the volume to be webcut);
- Webcut with: YZ Plane;
- Offset Value: 0.

Click **Apply**.

Do the same for the ZX Plane:

- Volume ID(s): 2 (the volume to be webcut);
- Webcut with: ZX Plane;
- Offset value: 0.

Click **Apply**.

As a result, the original volume in the Model Tree is split into three (Volume 2, Volume 3 and Volume 4).

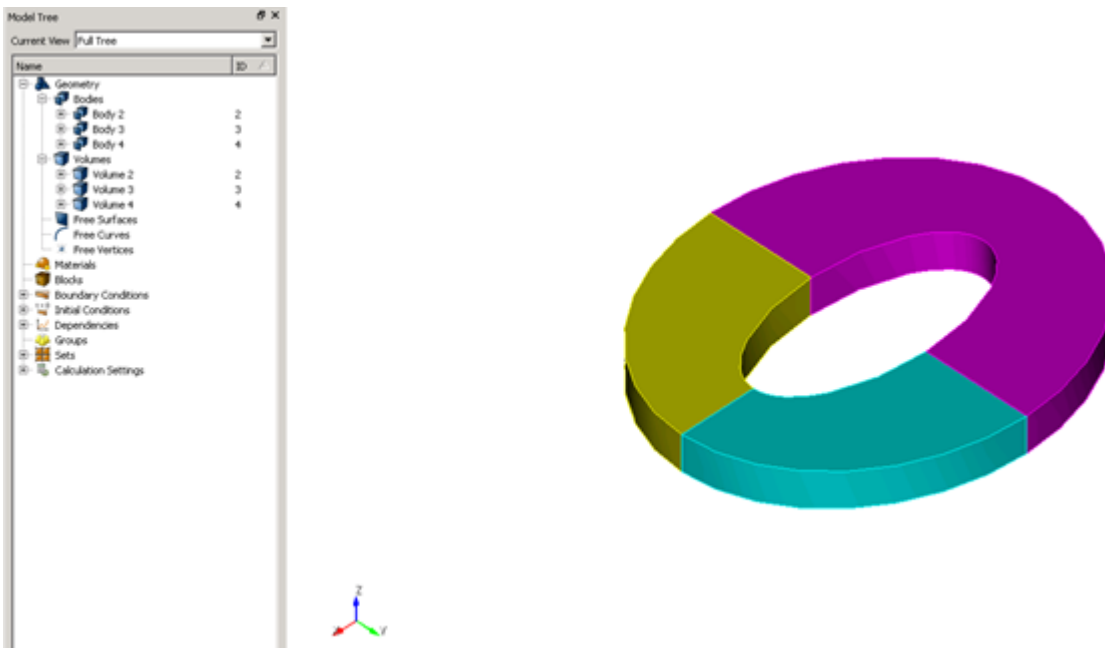

Delete the volumes 2 and 3. To do this, select these volumes in the Model Tree holding down Ctrl and click **Delete** in contextual menu. As a result, a quarter of the original volume is left (Volume 4).

5. Split the outer curvilinear surface into two (it is necessary for restraining this surface from displacements along the middle line).

Select surface geometry modification section on Command Panel (Mode — **Geometry**, Entity — **Volume**, Action — **Webcut**).



Set the following parameters:

- Coordinate Plane;
- Volume ID(s): 4 (*volume to be cut*);
- Plane: XY;
- Offset Value: 0;

- Put a checkmark in the **Merge** box.

Click **Apply**.

The result will be two volumes 4 and 5 glued to each other along the section plane:

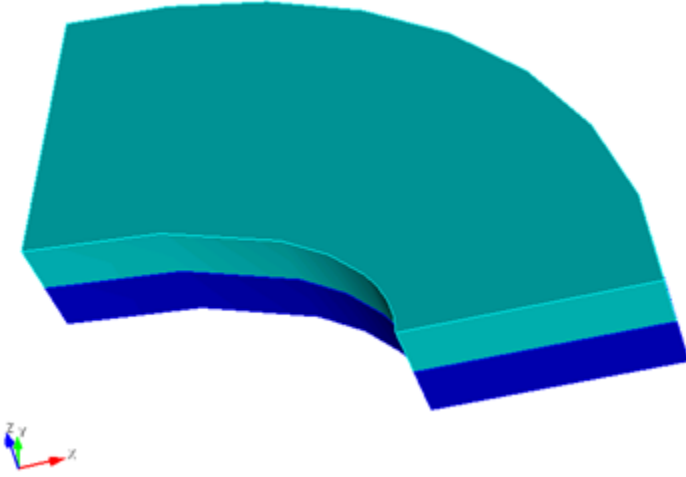

Meshing

1. Select meshing on curves section on Command Panel (Mode — **Mesh**, Entity — **Curve**, Action — **Mesh**).

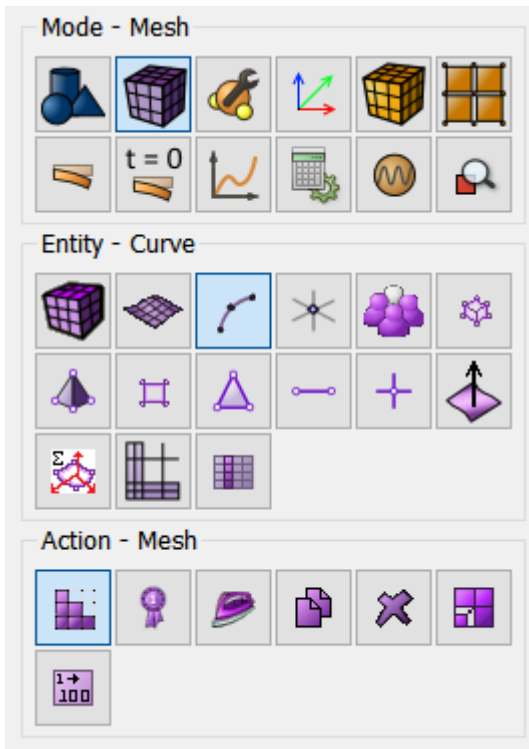

Specify the parameters of mesh refinement:

- Select Curves: 43 44 45 46 (*using space after each curve*);
- Select the way of meshing: Equal;
- Select the checkbox Interval;

- Specify the number of intervals: 6.

Click **Apply Size**.

Click **Mesh**.

2. Select meshing on curves section on Command Panel (Mode — **Mesh**, Entity — **Curve**, Action — **Mesh**).

- Select Curves: 12 14 39 41 (*using space after each curve*);
- Select the way of meshing: Equal;
- Select the checkbox Interval;
- Specify the number of intervals: 4.

Click **Apply Size**.

Click **Apply**.

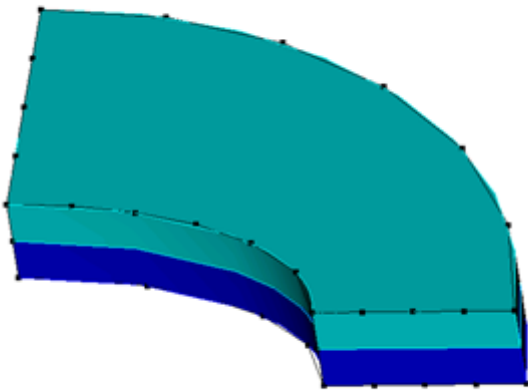

3. On the command panel, select the mesh generation mode on the curves (Mode - **Mesh**, Entity - **Curve**, Action – **Mesh**)

- Select Curves: 51 53 61 62 (through spaces);
- Settings for Curve: Equal;
- Set the Interval flag;
- Indicate the number of interval: 1.

Click **Apply Size**.

Click **Mesh**.

4. Select volume mesh generation section on Command Panel (Mode — **Mesh**, Entity — **Volume**, Action — **Mesh**).

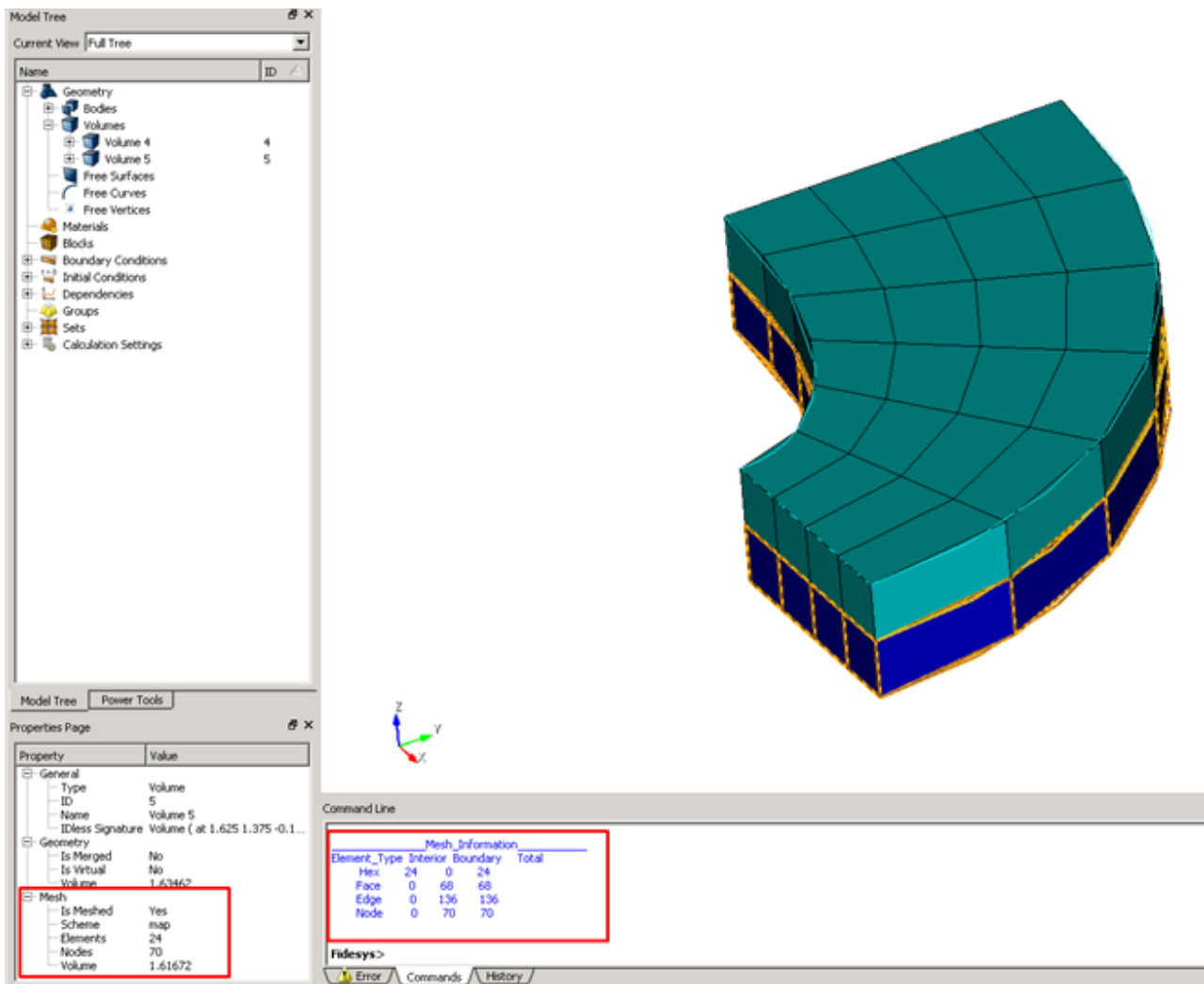

Setting boundary conditions

1. Fix one side (slice) along X axis.

Select on Command Panel (Mode — **Boundary Conditions**, Entity — **Displacement**, Action — **Create**).

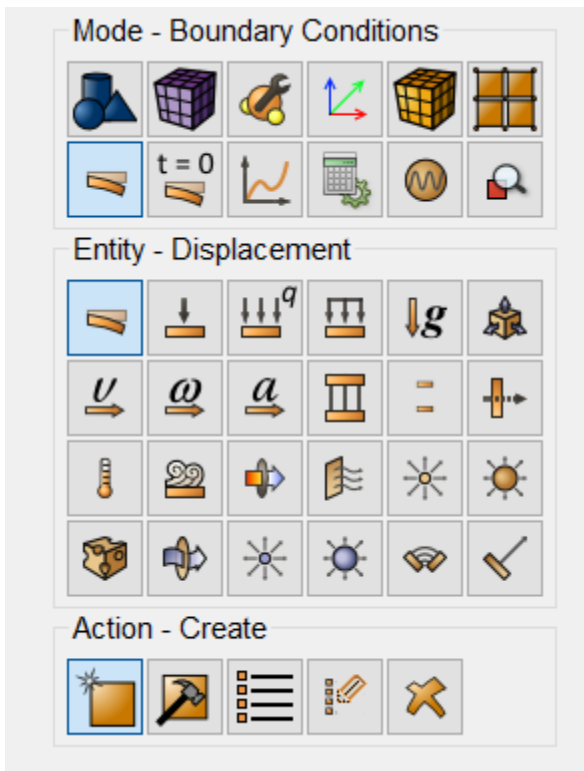

Set the following parameters:

- System Assigned ID;
- Entity List: Surface;
- Entity ID(s): 33 40;
- Degrees of Freedom: X - Translation Disp;
- DOF Value: 0.

Click **Apply**.

2. Fix one side (slice) along Y axis.

Select on Command Panel (Mode — **Boundary Conditions**, Entity — **Displacement**, Action — **Create**).

Set the following parameters:

- System Assigned ID;
- Entity List: Surface;
- Entity ID(s): 35 39;
- Degrees of Freedom: Y - Translation Disp;
- DOF Value: 0.

Click **Apply**.

3. Fix the outer curvilinear surface along X and Y axes.

Select on Command Panel (Mode — **Boundary Conditions**, Entity — **Displacement**, Action — **Create**).

Set the following parameters:

- System Assigned ID;
- Entity List: Surface;
- Entity ID(s): 36 38;
- Degrees of Freedom: X - Translation Disp and Y - Translation Disp;
- DOF Value: 0.

Click **Apply**.

4. Fix the middle line of the outer curvilinear side along Z axis.

Select on Command Panel (Mode — **Boundary Conditions**, Entity — **Displacement**, Action — **Create**).

Set the following parameters:

- System Assigned ID;
- Entity List: Curve;
- Entity ID(s): 50;
- Degrees of Freedom: Z - Translation Disp;
- DOF Value: 0.

Click **Apply**.

5. Apply pressure to the upper side.

Select (Mode – **Boundary Conditions**, Entity – **Pressure**, Action – **Create**).



Set the following parameters:

- System Assigned ID;
- Entity List: Surface;
- Entity ID(s): 31;
- Magnitude Value: $1e6$ (an exponential number format using the Latin letter “e” is supported).

Click **Apply**.

All applied boundary conditions must be displayed in the Model Tree on the left. In addition, the boundary conditions are available for editing from the Model Tree.

To view all the applied boundary conditions also click Show BC on the top panel.

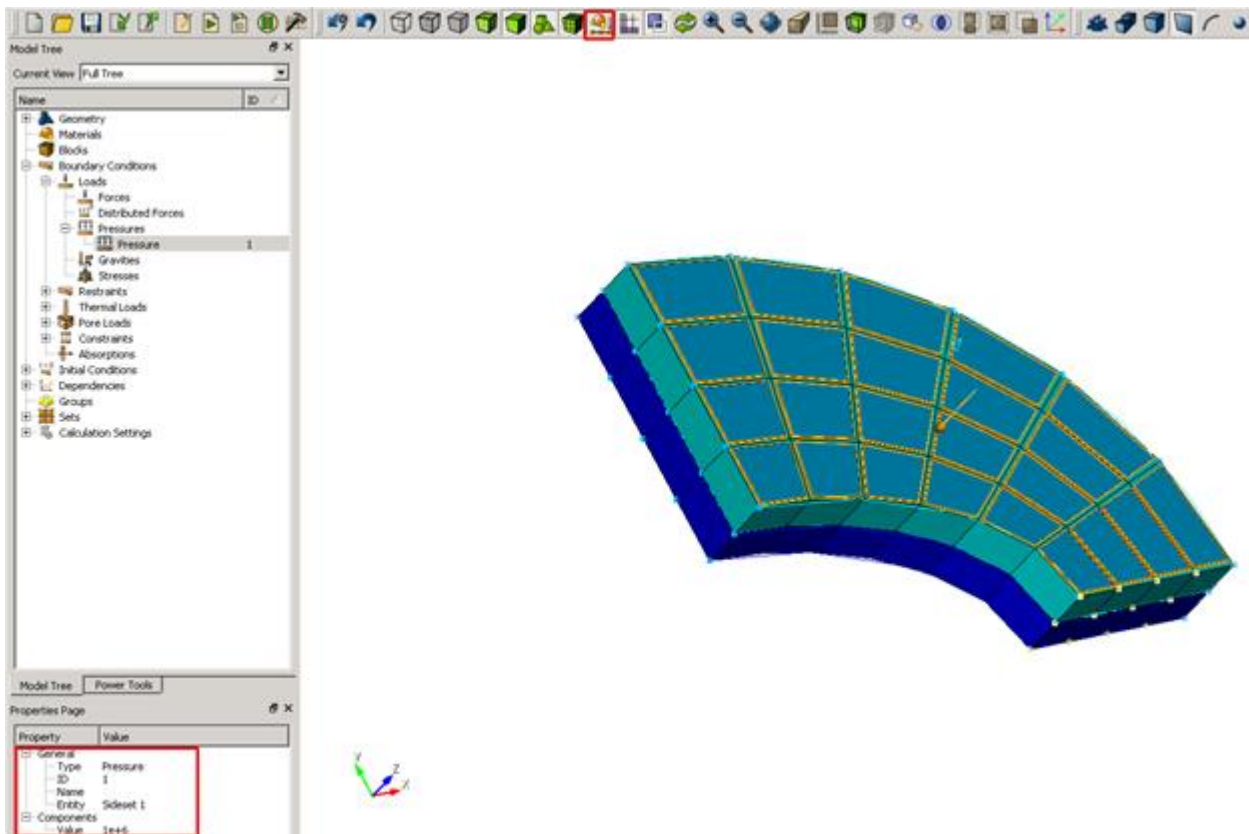

Setting material and block properties

1. Create the material.

Select setting the material properties section on Command Panel (Mode — **Material**, Entity — **Materials Management**).

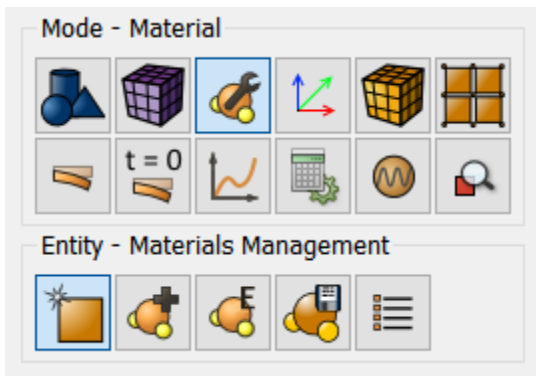

In the Materials Management window that opens, in the second column, double-click on the caption. Enter the name of the material and write “Material 1”. Press the ENTER key.

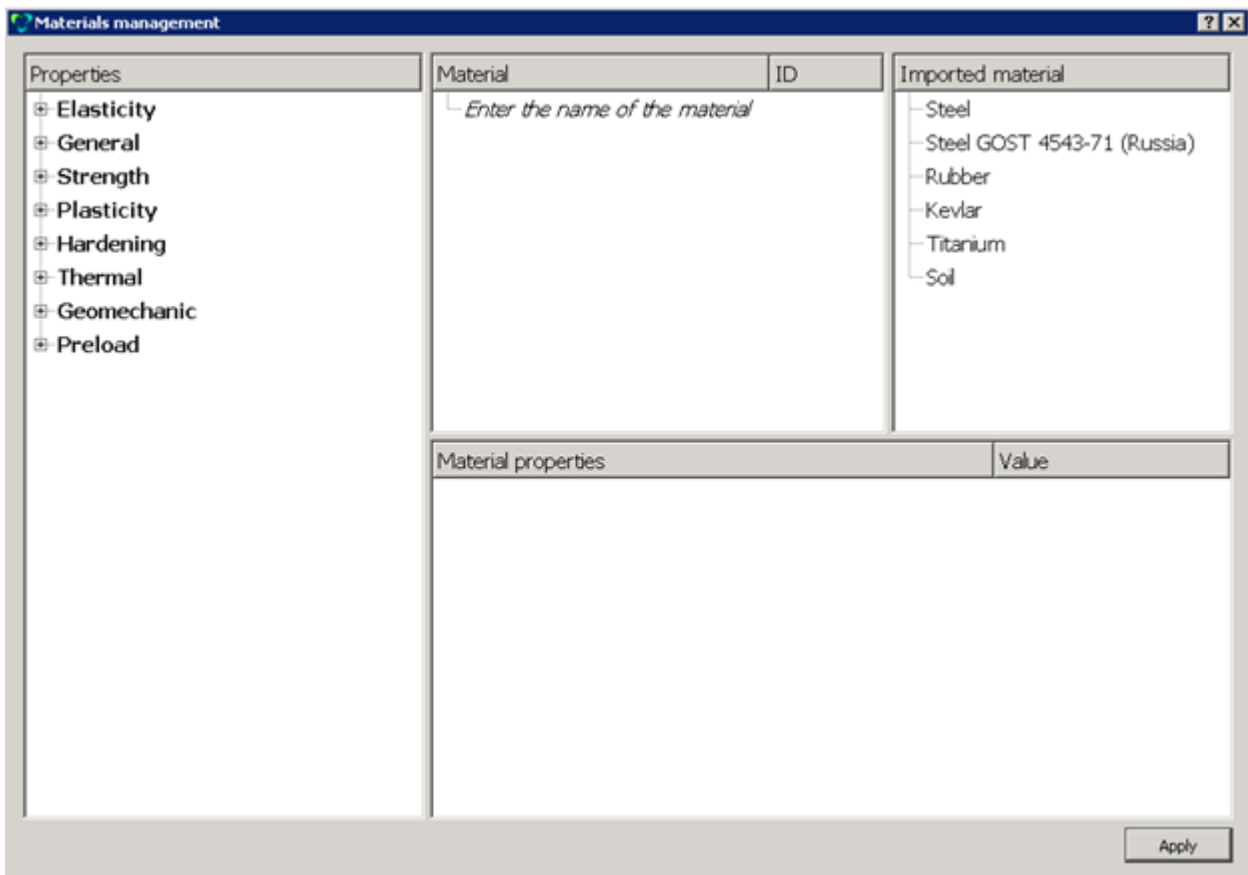

Next, using the “drag & drop” method, add the necessary characteristics from the left column to the Material Properties column.

In the left column, select Elasticity - Hooke Material. Select with the mouse the characteristic Young's modulus. Hold down the left mouse button and drag the label to Material Properties. Double-click in the Value field opposite the Young Module and enter the number 210e9.

Similarly, from the Hooke Material section add the Poisson Ratio 0.3.

Click **Apply**.

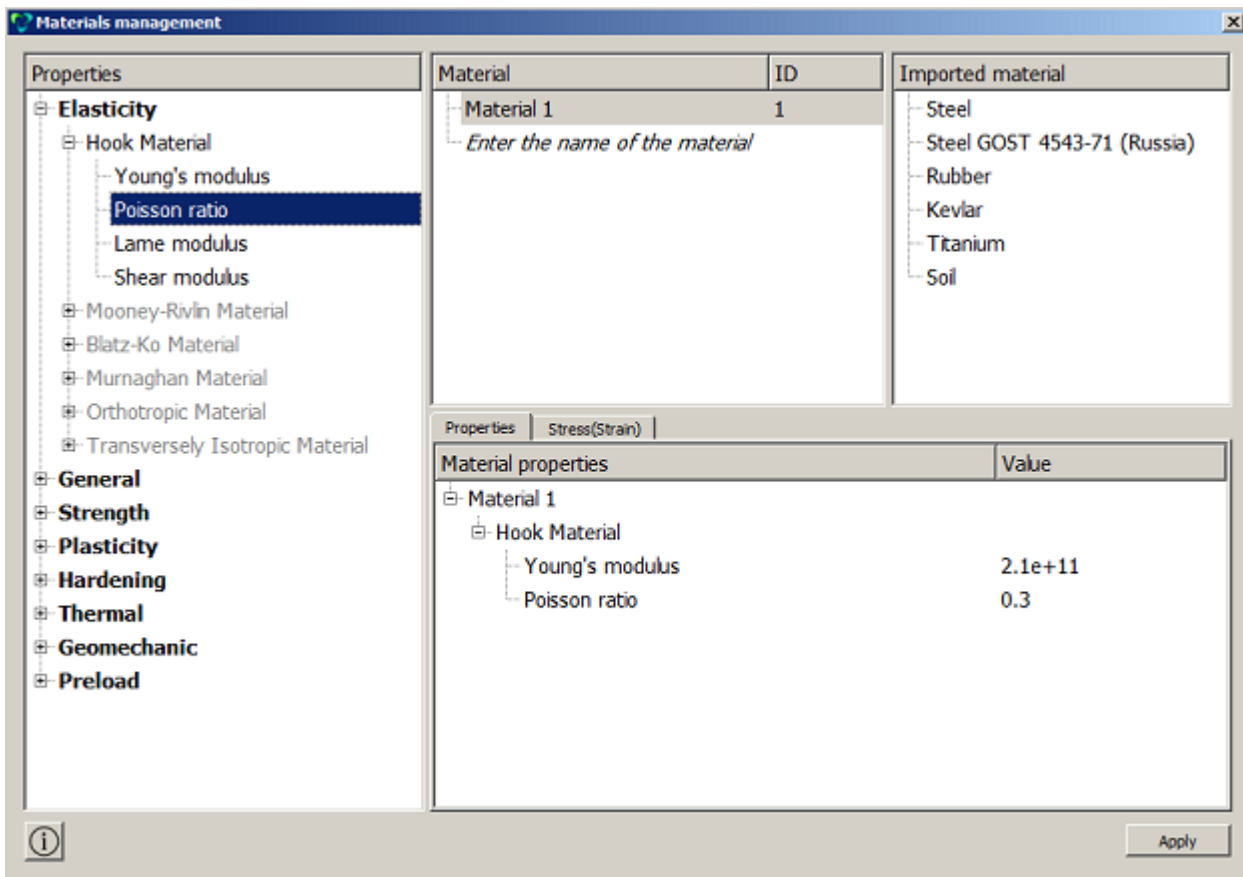

2. Create a block of one type of the material.

Select setting the material properties section on Command Panel (Mode — **Blocks**, Entity — **Block**, Action — **Add**).



Set the following parameters:

- Block ID: 1;
- Entity List: Volume;

- Entity ID(s): 4 5 (or by the command *all*).

Click **Apply**.

3. Set the block parameters.

On the command panel, select the mode for setting material properties (Mode - **Blocks**, Entity - **Block**, Action - **Block properties/parameters**).

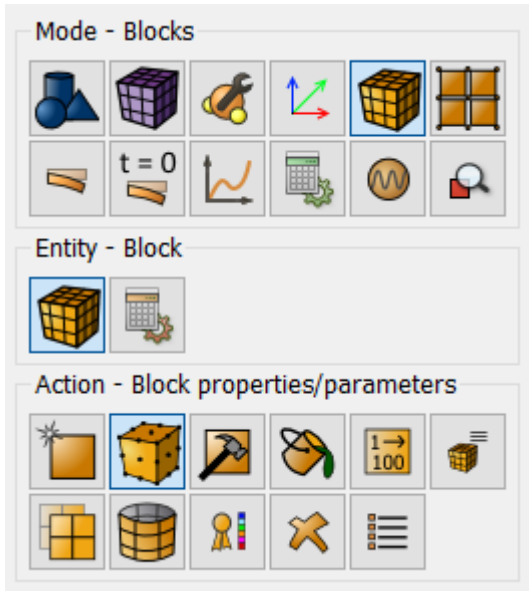

Set the following parameters:

- Block ID(s): 1;
- Category: Solid;
- Material: Material 1;
- Coordinate System: Global Cartesian;
- Order: 1.

Click **Apply**.

Starting calculation

1. Set the type of the problem to be solved.

Select calculation settings section on Command Panel (Mode — **Calculation Settings**, Calculation Settings — **Static**, Static — **General**).

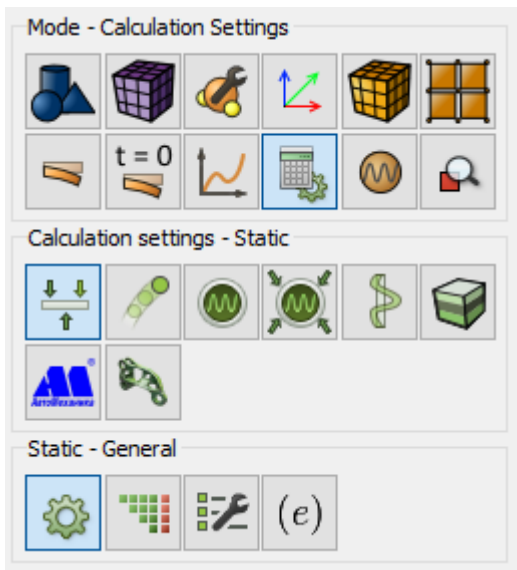

Select:

- Dimension: 3D;
- Model: Elasticity.

Click **Apply**.

2. Set the solver settings.

Select calculation setting section on Command Panel (Mode — **Calculation Settings**, Calculation Settings — **Static**, Static — **Solver**).

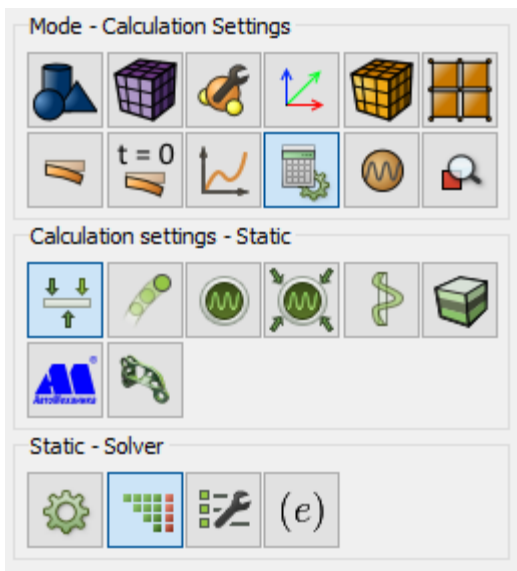

Select the solver method (direct or iterative) and set Convergence Parameters in case of choosing an iterative one. You can also leave all the settings by default.

Click **Apply**.

Click **Start Calculation**.

3. In a pop-up window select a folder to save the result and enter the file name.

4. If the calculation is finished successfully, you will see a message in the Console: “*Calculation finished successfully at <date> <time>*”.

Results analysis

1. Open the file with the results. You can do this in one of the three ways.

- Press Ctrl+E.
- Select **Results** in the Main Menu. Click **Open last result**.
- Select **Results** on Command Panel (Mode – **Results**). Click **Open Results**.



2. Display the component σ_{yy} of the stress field and the mesh on the model.

In *Fidesys Viewer* window set the following parameters on Toolbar:

- Representation Mode: Surface;
- Representation Field: Stress;
- Representation Component: YY.
- Surface with edges.



3. Select a point where you need to view the stress.

Select a point on the model by using **Select Points Through**.

Select a point D on the upper side. From the main menu, select View – **Selection Display Inspector**.

In **Selection Display Inspector**, go to the tab **Point Tag** and select and click on the Stress line in the drop-down list.

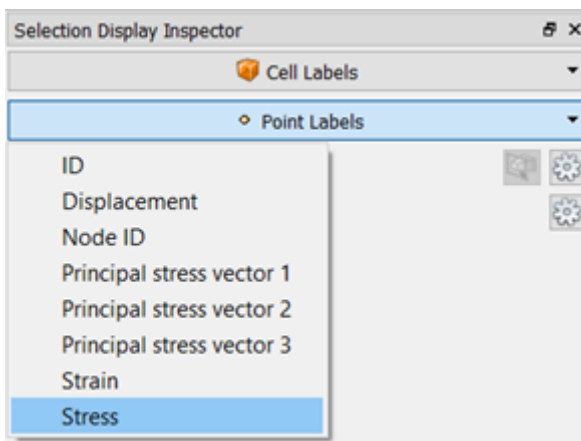

As a result, Stress components at the point D are displayed at the picture.

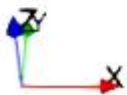
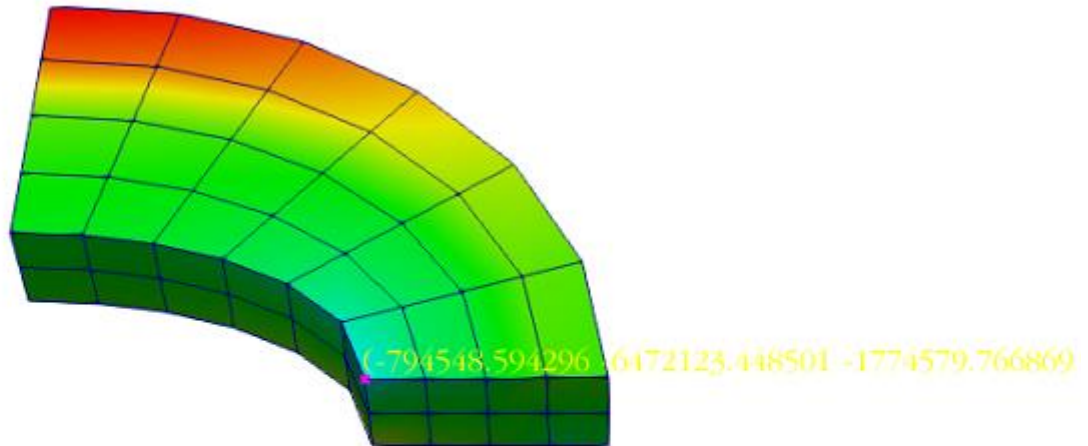

- 4. View the numerical value σ_{yy} at the selected point D.

The difference between the obtained value $-5.266e+06$ and the required one $-5.380e+06$ is 2.12%.

- 5. Download numerical data.

Select **File** → **Save Data** in the Main Menu or click **Ctrl+S**. Enter the file name (*.csv format), leave it by default. Click **OK**. The saved file is an ordinary table of numerical data which can be opened in any text editor.

- 6. You can see the way the body is deformed under the applied pressure.

To do this select the filter **Warp By Vector**. Set the following parameters in the tab **Properties**: set the value to 5000 in the field **Scale Factor**.

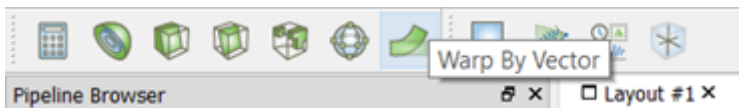

As a result, the deformed body is displayed in the picture. To see the original model, click near it in the Model Tree. The picture below shows the deformed (solid grey filling) and the original model (with the field of displacements distribution along Y axis).

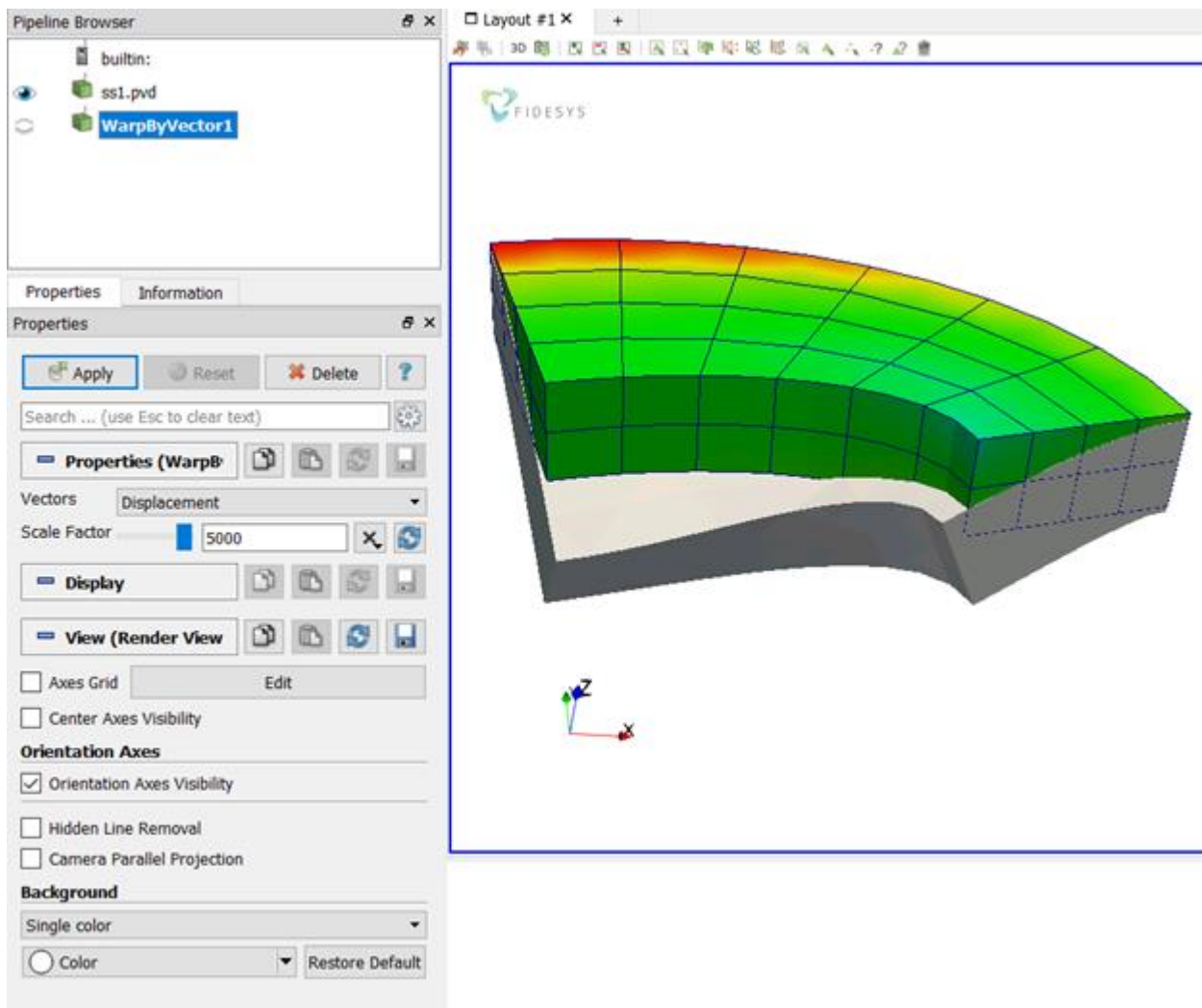

Using Console Interface

For geometry generation, meshing, setting boundary conditions and materials you can use Console Interface.



It is also possible to run the file *static_solid_3D.jou* by selecting Journal Editor on Toolbar. In a pop-up window of the main menu select **File** → **Open** and open the necessary journal file.

Static load (gravity force)

R.J. Roark, Formulas for Stress and Strain, 4th Edition? McGraw-Hill Book Co., Inc., New York, NY, 1965, pg 112, no. 33

The problem of the tube bending of under gravity force is to be solved. The pictures below represent a geometric model of the problem:

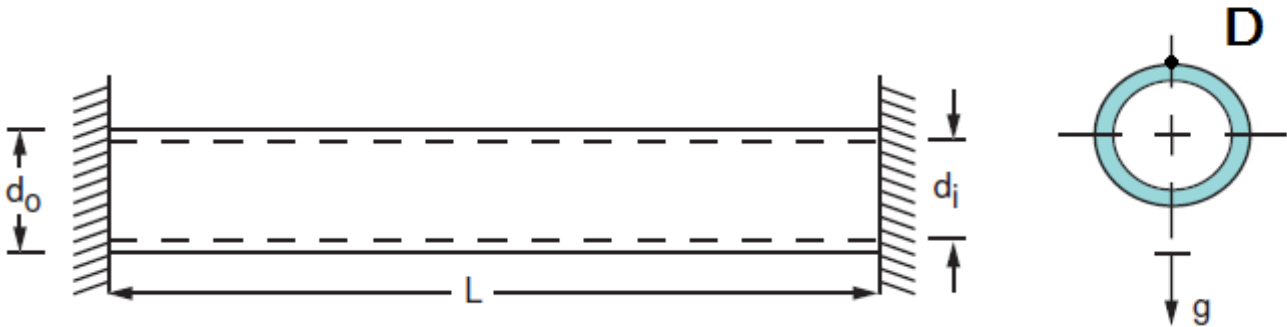

The side edges are rigidly fixed on all displacements and rotations. Material parameters are $E = 30e6$ psi, $\nu = 0.0$, $\rho = 0.00073$ lb-sec²/in⁴. The gravity force is defined via the acceleration $g = 386$ in/sec². The geometrical dimensions of the model: $L = 200$ in, $d_o = 2$ in, $d_i = 1$ in.

Due to the symmetry of the problem, half tube will now be considered ($L/2$).

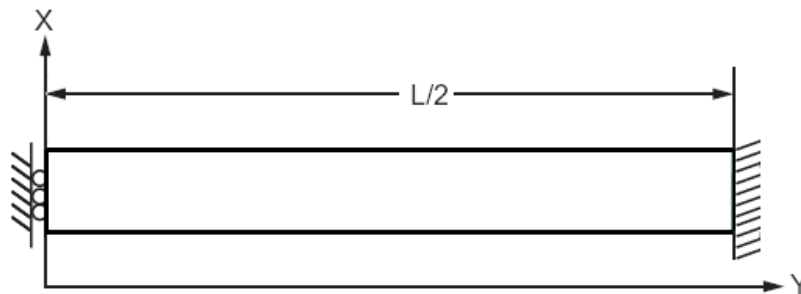

Test pass criterion is the following: displacement in the center of the tube u_{yy} at the point D $(0, d_o/2, 0)$ is -0.12529 within 3%.

Geometry creation

1. Create the first circular cylinder.

Select volume geometry generation section on Command Panel (Mode - **Geometry**, Entity - **Volume**, Action - **Create**).

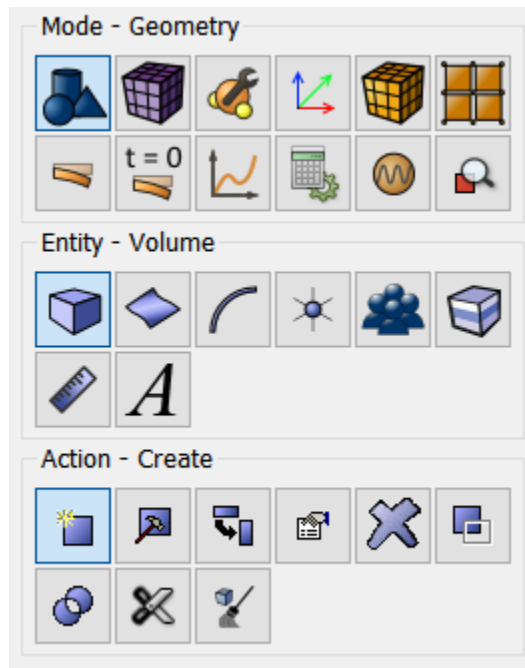

Select **Cylinder** in the list of geometric elements. Specify the cylinder dimensions:

- Height: 100;
- Cross section: Circular;
- Radius: 1.

Click **Apply**.

2. Create the second cylinder.

Select volume geometry generation section on Command Panel (Mode - **Geometry**, Entity - **Volume**, Action - **Create**).

Select **Cylinder** in the list of geometric elements. Specify the cylinder dimensions:

- Height: 100;
- Cross section: Circular;
- Radius: 0.5.

Click **Apply**.

As a result, two generated entities are displayed in the Model Tree (Volume 1 and Volume 2).

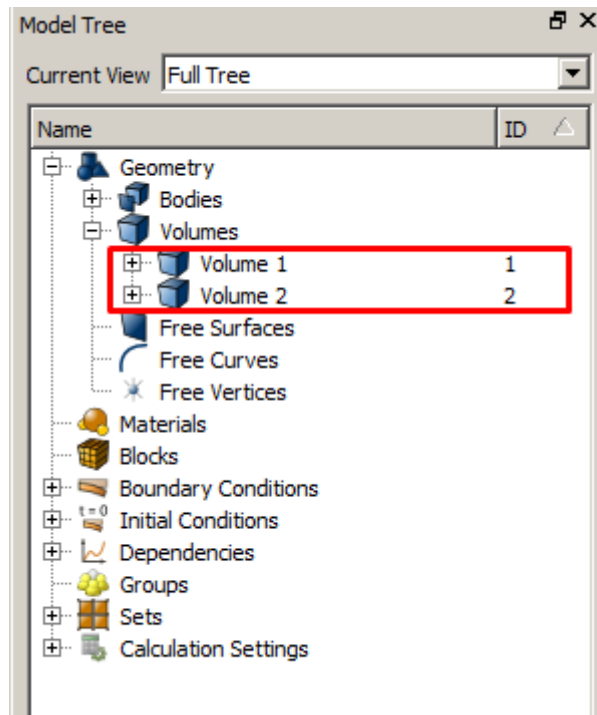

3. Subtract the first cylinder from the second one.

Select volume geometry generation section on Command Panel (Mode - **Geometry**, Entity - **Volume**, Action - **Boolean**).

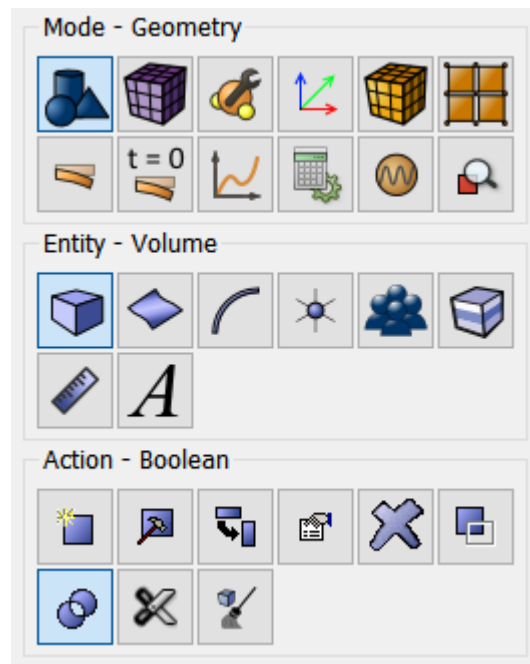

Select **Subtract** in the list of operations. Set the following parameters:

- A Volume ID(s): 1 (*the volumes to be subtracted*);
- B Volume ID(s): 2 (*volumes from which other volumes will be subtracted*).

Click **Apply**.

As a result, only one volume is displayed in the Model Tree (Volume 1).

4. Place the volume to the coordinate origin.

Select volume geometry generation section on Command Panel (Mode - **Geometry**, Entity - **Volume**, Action - **Transform**).

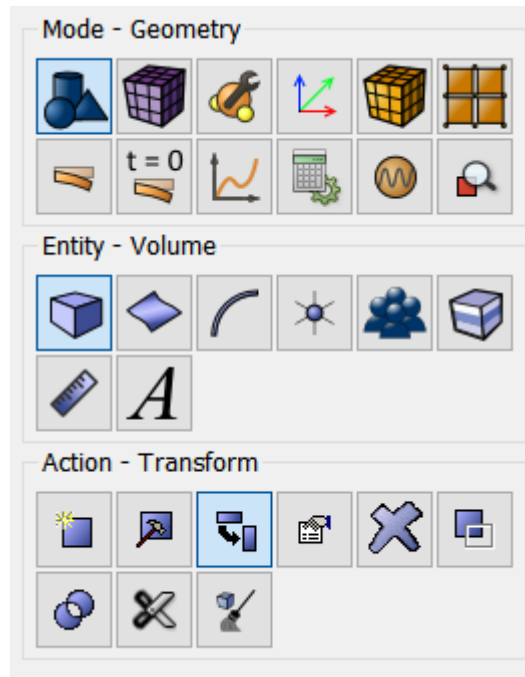

Select **Move** from the list of possible types of slices.

et the following parameters:

- Volumes ID(s): 1 (the volume to be cut);
- Select Method: Distance;
- Z Distance: 50.

Click **Apply**.

Thus, the center of the left end of the tube is placed in the origin of coordinates.

Meshing

1. Set the approximate size of the elements.

Select volume mesh generation section on Command Panel (Mode - **Mesh**, Entity - **Volume**, Action - **Intervals**).

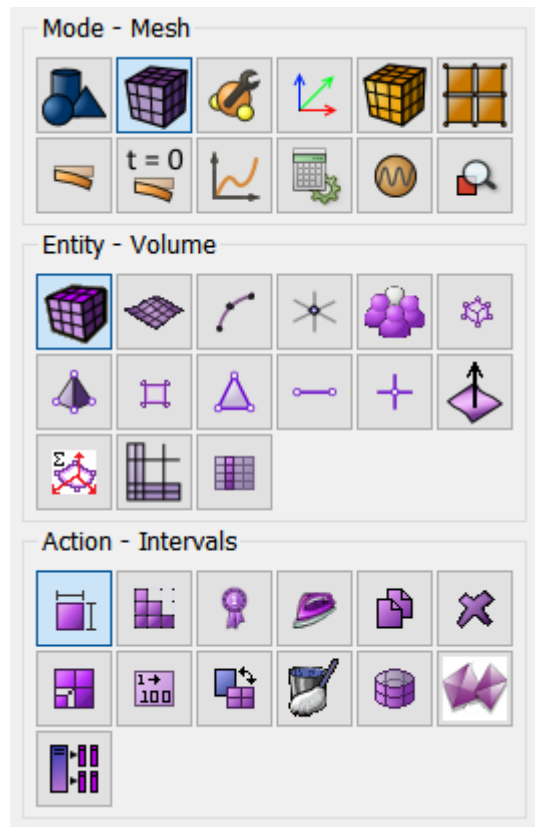

Specify the **Approximate Size** of the elements:

- Select Volumes: 1;
- Approximate Size: 0.25.

Click **Apply Size**.

2. Select the way of mesh generation.

Select volume mesh generation section on Command Panel (Mode - **Mesh**, Entity - **Volume**, Action - **Mesh**).

- Select meshing scheme: Polyhedron.
- Select Volumes: 1.

Click **Apply Scheme**.

Click **Mesh**.

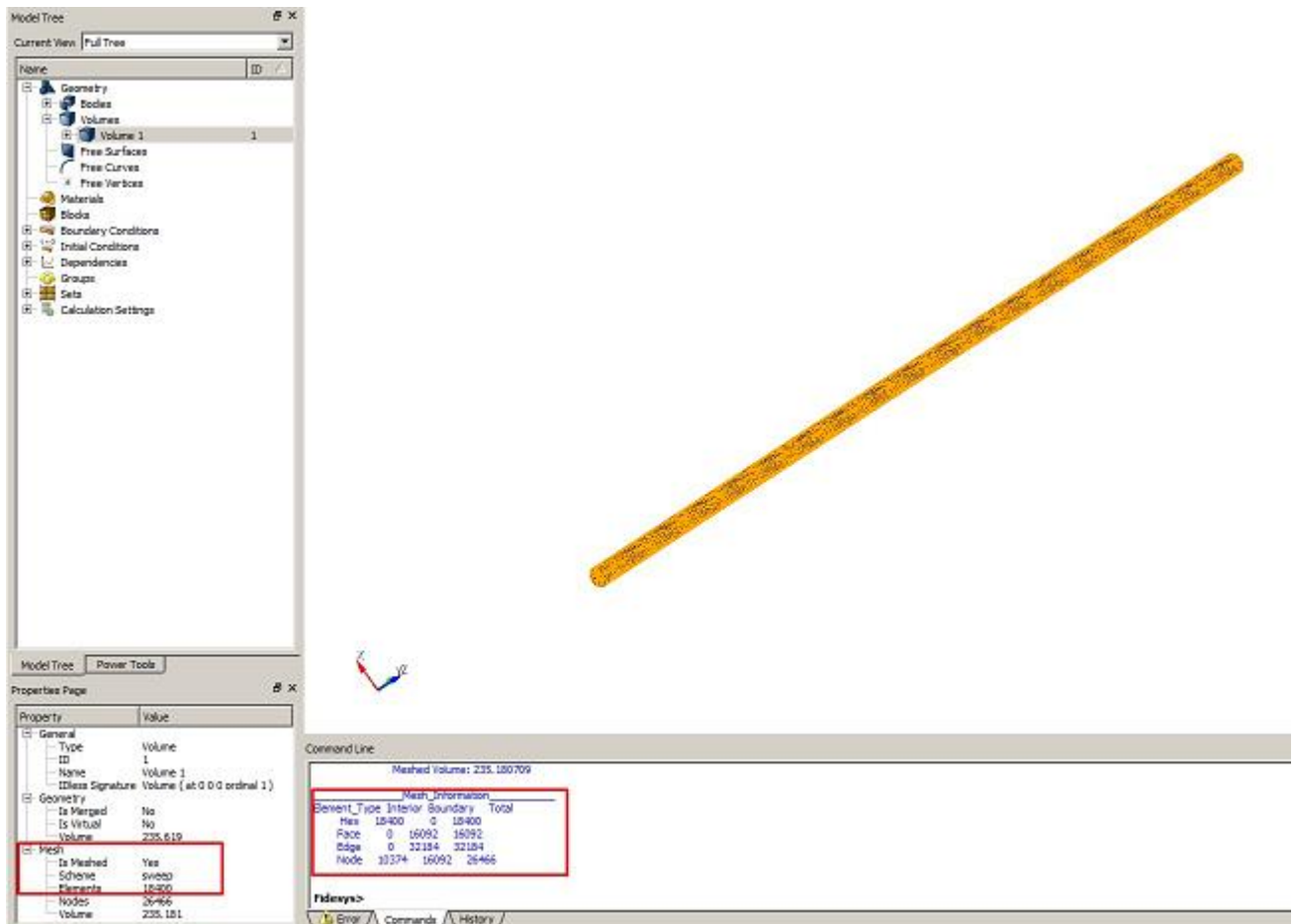

The resulting number of elements can be found on the property page by clicking on Volume 1 in the Model Tree on the left.

To view the mesh properties, you can follow these steps:

- Select the entire model;
- Right-click on the model;
- In the pop-up menu, select List Information - List Mesh Info;
- Information on the mesh will be displayed in Command Line.

Setting boundary conditions

1. Fix the right lateral edge at all directions.

Select on Command Panel (Mode - **Boundary Conditions**, Entity - **Displacement**, Action - **Create**).

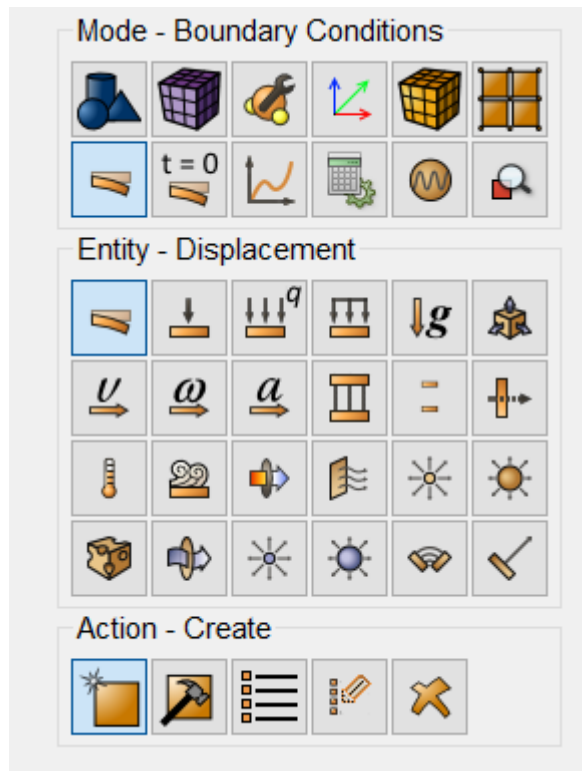

Set the following parameters:

- System Assigned ID;
- Entity List: Surface;
- Entity ID(s): 8;
- Degrees of Freedom: All;
- DOF Value: 0.

Click **Apply**.

2. Fix the left lateral edge along X and Z axes by analogy.

Select on Command Panel (Mode - **Boundary Conditions**, Entity - **Displacement**, Action - **Create**).

Set the following parameters:

- System Assigned ID;
- Entity List: Surface;
- Entity ID(s): 9;
- Degrees of Freedom: X-Translation Disp, Z-Translation Disp;
- DOF Value: 0.

Click **Apply**.

3. Set the gravity force.

Select on Command Panel (Mode - **Boundary Conditions**, Entity - **Gravity**, Action - **Create**).



Set the following parameters:

- System Assigned ID;
- Entity List: Global;
- Directions: Y;
- Y: -386.

Click **Apply**.

Setting material and block properties

1. Create the material.

Select setting the material properties section on Command Panel (Mode - **Material**, Entity - **Materials Management**).

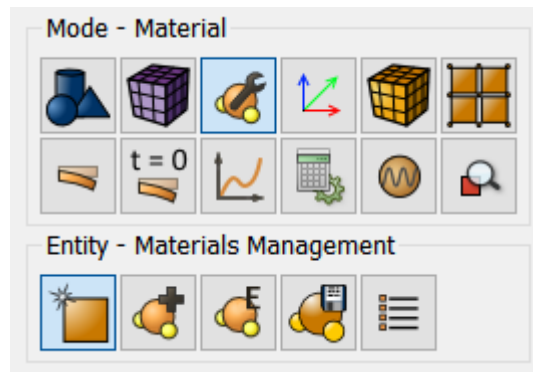

In the Materials Management window that opens, in the second column, click on the caption Enter the name of the material and write Material 1 • . Press the ENTER key.

In the left column, select Elasticity - Hooke Material. Select with the mouse the characteristic Young's modulus. Hold down the left mouse button and drag the label to Material Properties. Double-click in the Value field next to Young's modulus and enter the number 30e6.

Similarly, from the Hooke Material section add the Poisson Ratio 0 ; from the section General - Density: 0.00073.

Click **Apply**.

Materials management

Material	ID
Material 1	1

Imported material

- Steel
- Steel GOST 4543-71 (Russia)
- Rubber
- Kevlar
- Titanium
- Soil

Properties

- Elasticity**
 - Hook Material
 - Young's modulus
 - Poisson ratio
 - Lame modulus
 - Shear modulus
 - Mooney-Rivlin Material
 - Blatz-Ko Material
 - Murnaghan Material
 - Orthotropic Material
 - Transversely Isotropic Mate...
- General**
 - Density
 - Damping coefficient
 - Mass damping coefficient
 - Stiffness damping coefficient
- Strength
- Plasticity
- Hardening
- Thermal
- Geomechanic

Material properties

Material properties	Value
Material 1	
Hook Material	
Young's modulus	3e+07
Poisson ratio	0
General	
Density	0.00073

Apply

2. Create the block of one material type.

Select setting the material properties section on Command Panel (Mode - **Blocks**, Entity - **Block**, Action - **Add**).

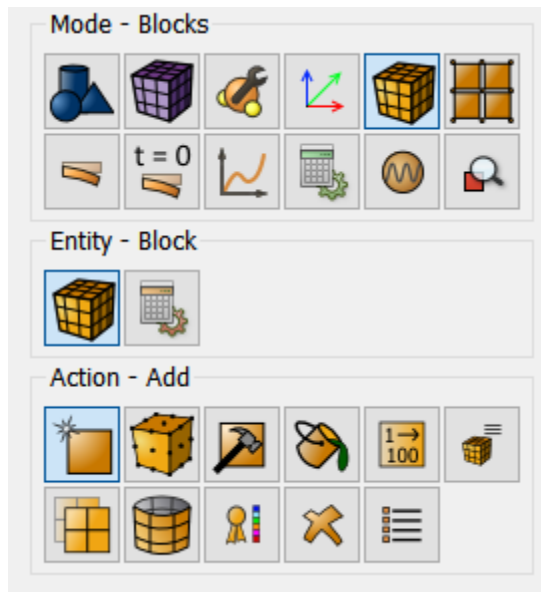

Set the following parameters:

- Block ID: 1;
- Entity List:: Volume;
- Entity ID(s): 1 (*or by the command **all***).

Click **Apply**.

3. Set the block parameters.

On the command panel, select the mode for setting material properties (Mode - **Blocks**, Entity - **Block**, Action - **Block properties/parameters**).

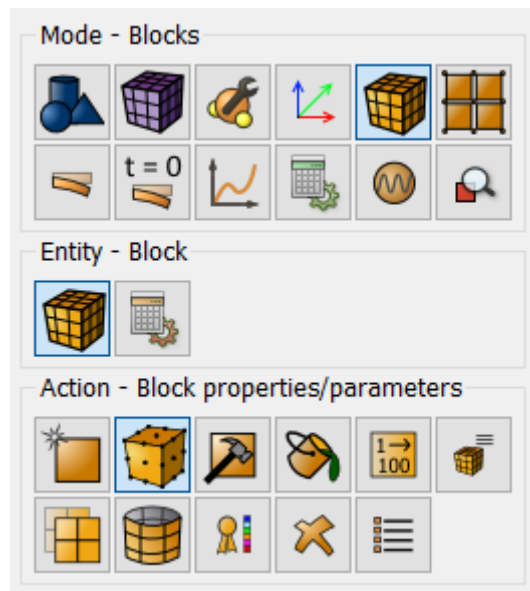

Set the following parameters:

- Block ID(s): 1;
- Category: Solid;

- Material: Material 1;
- Coordinate System: Global Cartesian;
- Order: 1.

Click **Apply**.

Starting Calculation

1. Set the type of the problem to be solved.

Select calculation setting section on Command Panel (Mode - **Calculation Settings**, Calculation settings - **Static**, Static - **General**).

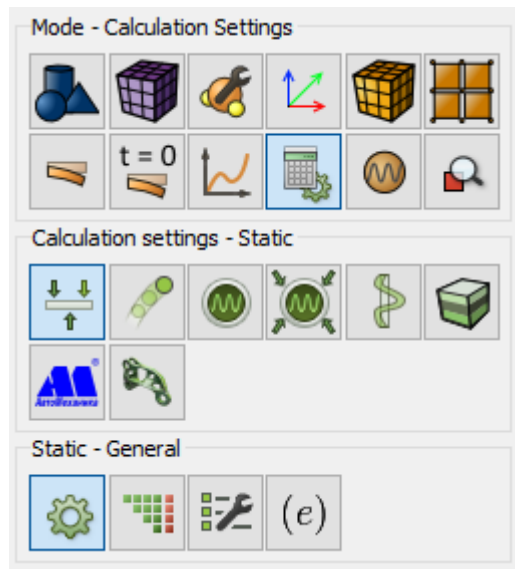

Select:

- Dimension: 3D;
- Model: Elasticity.

Click **Apply**.

In a pop-up window select a folder to save the result and enter the file name.

If the calculation is finished successfully, you will see a message in the Console: "*Calculation finished successfully at <date> <time>*".

Results analysis

1. Open the file with the results. There are three ways to do this.

- Click Ctrl+E.
- Select **Calculation** → **Open Results** in the Main Menu. Click **Open last result**.
- Select **Results** on Command Panel (Mode - **Results**). Click **Open Results**.

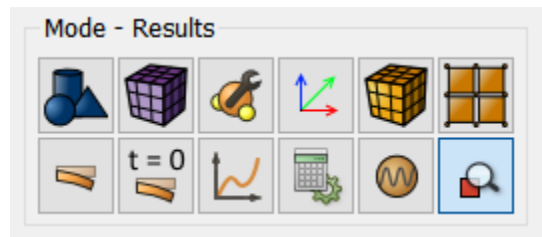

To apply all of the filters changes automatically in **Fidesys Viewer**, click **Apply changes to parameters automatically** on Command Panel.

2. Display the U_{yy} component of the displacement field on the model.

In **Fidesys Viewer** window set the following parameters on Toolbar:

- Representation Mode: Surface;
- Representation Field: Displacement;
- Representation Component: Y;
- Surface.

After applying the settings, you will see the following picture:

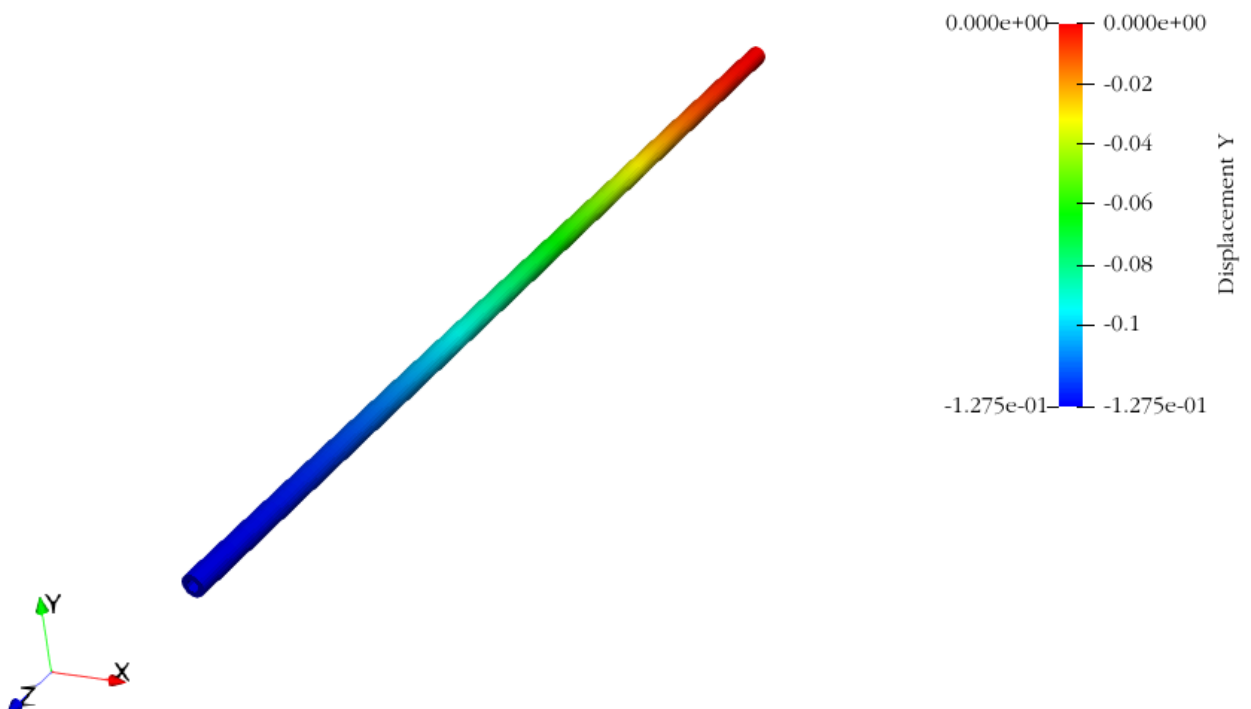

3. Check the maximum value U_{yy} at the selected point D.

In the picture, it is the maximum in modulus Displacement (blue). It corresponds to -0.127222 in the color legend.

The difference between the resulting value -0.1254 and the required -0.12524 is 0.13%.

4. Download numerical data.

Select **File** → **Save Data** in the Main Menu or click **Ctrl+S**. Enter the file name (*.csv format), leave it by default. Click **OK**. The saved file is an ordinary table of numerical data which can be opened in any text editor.

5. You can see the way the body is deformed under the applied pressure.

To do this, select **Filters** → **Alphabetical** → **Warp By Vector**. Set the following parameters in the tab **Properties**:

- Vectors: Displacement;
- Scale Factor: 100.

As a result, the deformed body is displayed at the picture. To see the original model, click the button near the model in the Model Tree. The picture below shows the deformed (solid grey filling) and the original model (with the field of displacements distribution along Y axis).

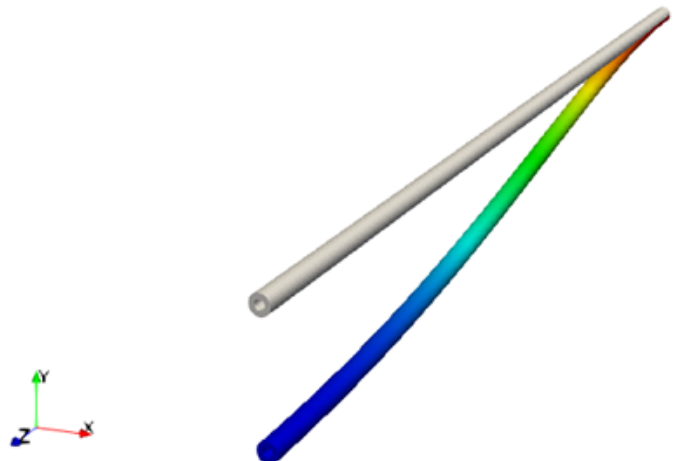
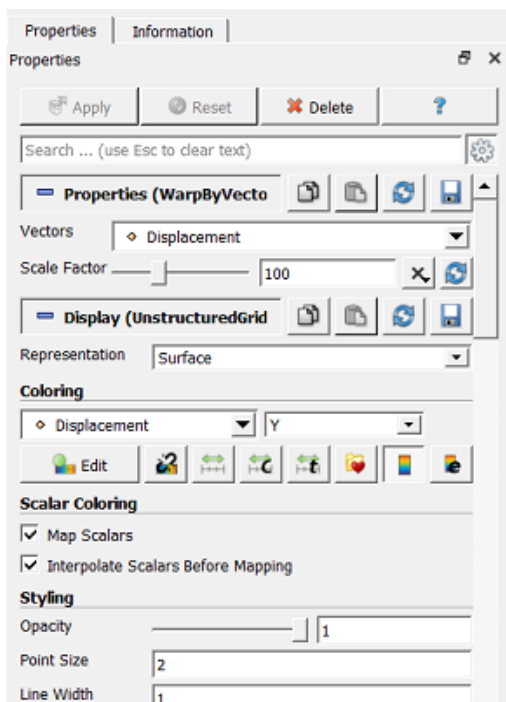

Using Console Interface

For geometry generation, meshing, setting boundary conditions and materials you can use Console Interface.



It is also possible to run the file *static_gravity_solid.jou* by selecting Journal Editor on Toolbar. In a pop-up window of the main menu select **File** → **Open** and open the necessary journal file.

Static load (beam model, reaction forces)

S.H. Crandall, N.C. Dahl, An Introduction to the Mechanics of Solids, McGraw-Hill Book Co., Inc., New York, NY, 1959, pg. 389, ex. 8.9

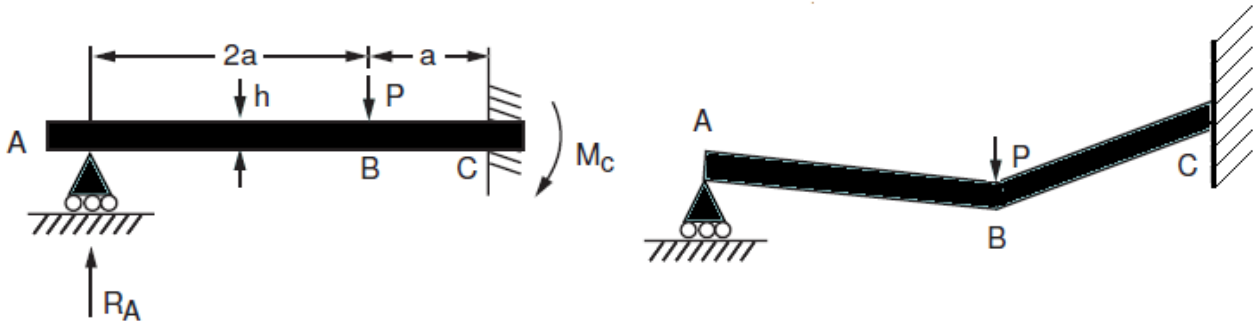

The problem of static load of a square section beam is being solved. The picture represents a geometric model of the problem: $a = 50$ In, beam section 1×1 in. The boundary conditions are presented in the picture; the force applied at the point B is $F_y = -1000$ lb. The material parameters are $E = 30e6$ psi, $\nu = 0.3$.

Test pass criterion is the following: reaction force R_A at the point A (0,0,0) is 148.15 lb, reaction moment at the point C is 27778 in-lb within 1.5%.

Geometry creation

1. Create a straight line 100 in length (segment AB).

Select volume geometry generation section on Command Panel (Mode — **Geometry**, Entity — **Curve**, Action — **Create**).

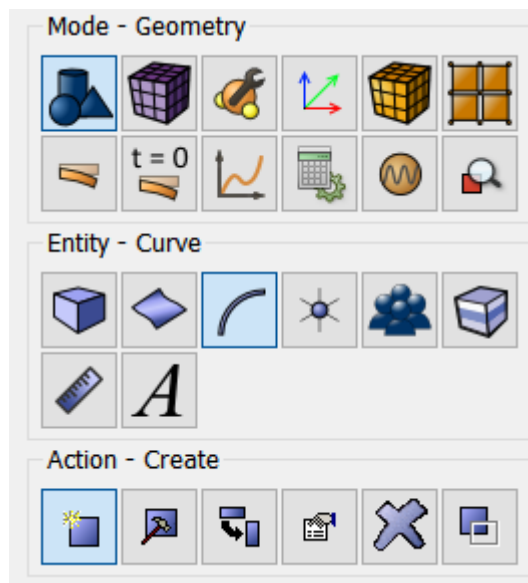

Select **Line** in the list of geometric elements. Create it using **Location and Direction**. Set the following parameters:

- Location: 0 0 0 (*line origin*);
- Direction: 1 0 0 (*along X axis*);
- Length: 100.

Click **Apply**.

2. Create a straight line 50 in length (segment BC).

Select volume geometry generation section on Command Panel (Mode — **Geometry**, Entity — **Curve**, Action — **Create**).

Select Line in the list of geometric elements. Create it using **Location and Direction**. Set the following parameters:

- Location: 100 0 0 (*line origin*);
- Direction: 1 0 0 (*along X axis*);
- Length: 50.

Click **Apply**.

As a result, in left side of the Model Tree there are two free curves having no common vertices.

3. Unite two vertices.

Select volume geometry generation section on Command Panel (Mode — **Geometry**, Entity — **Vertex**, Action — **Merge**).

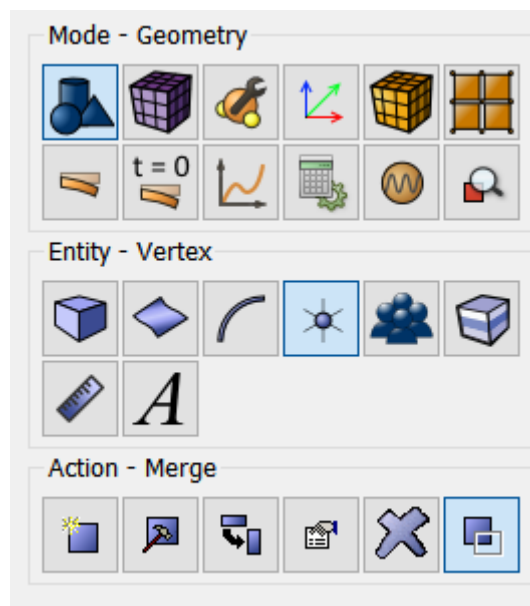

Set the following parameters:

- Vertex ID(s): 2 3 (*using space after each of them*).

Click **Apply**.

Meshing

1. Select meshing on curves section on Command Panel (Mode — **Mesh**, Entity — **Curve**, Action — **Mesh**).

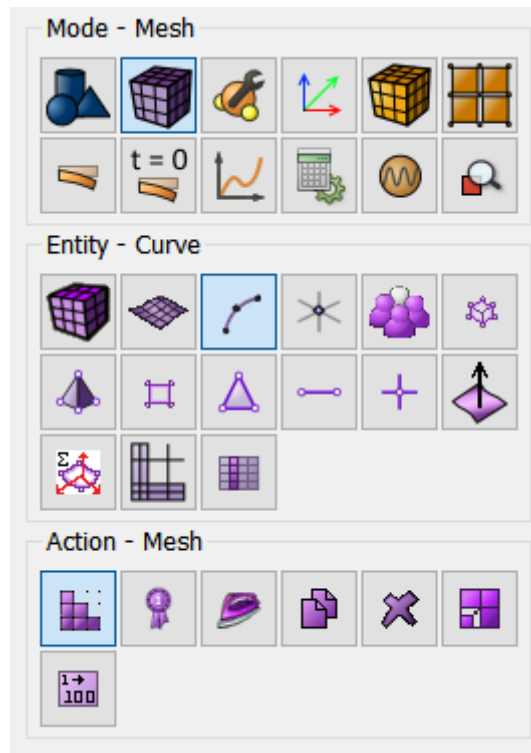

Specify the parameters of mesh refinement:

- Select Curves: all;
- Select the way of meshing: Equal;
- Select the meshing parameters: Interval;
- Interval: 1.

Click **Apply Size**.

Click **Mesh**.

Setting boundary conditions

1. Fix the point C at all directions.

Select on Command Panel (Mode — **Boundary Conditions**, Entity — **Displacement**, Action — **Create**).

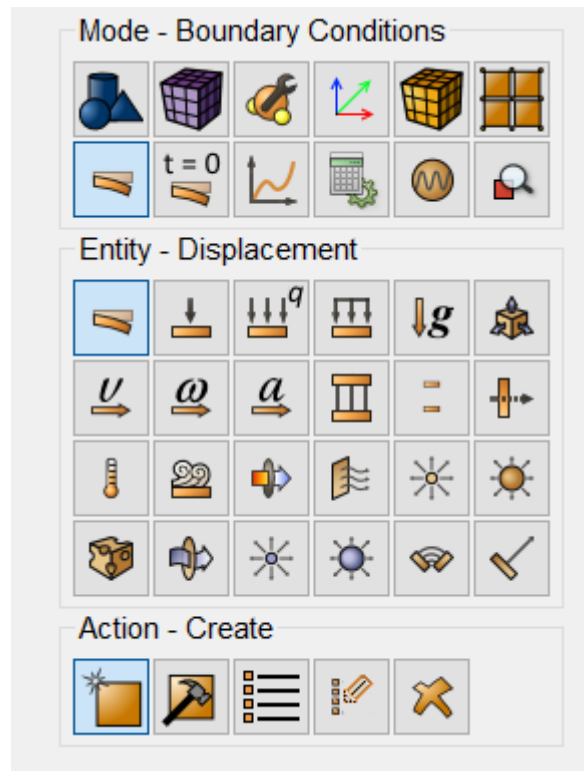

Set the following parameters:

- System Assigned ID;
- Entity List: Vertex;
- Entity ID(s): 4;
- Degrees of Freedom: All;
- DOF Value: 0.

Click **Apply**.

2. Fix the point A at the Y and Z displacement.

Select on Command Panel (Mode — **Boundary Conditions**, Entity — **Displacement**, Action — **Create**).

Set the following parameters:

- System Assigned ID;
- Entity List: Vertex;
- Entity ID(s): 1;
- Degrees of Freedom: Y - Translation Disp, Z - Translation Disp;
- DOF Value: 0.

Click **Apply**.

3. Apply force at the point B.

Select on Command Panel (Mode — **Boundary Conditions**, Entity — **Force**, Action — **Create**).

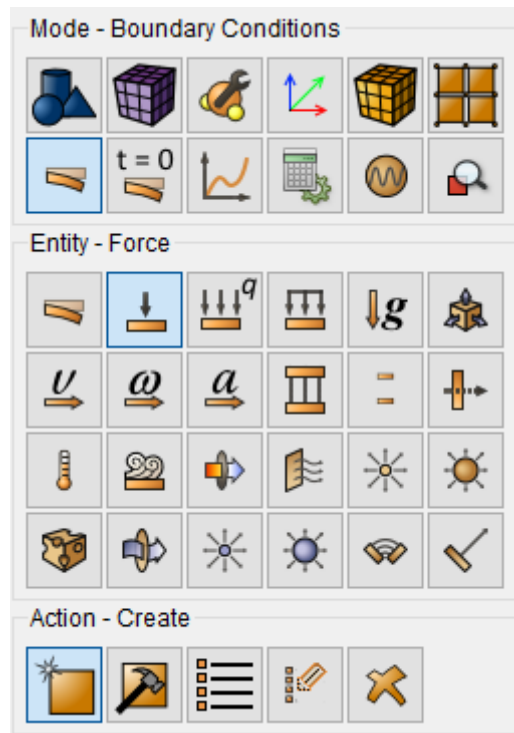

Set the following parameters:

- System Assigned ID;
- Force Entity List: Vertex;
- Entity ID(s): 2;
- Force: 1000;
- Direction 0 -1 0.

Click **Apply**.

Setting material and block properties

1. Create the material.

Select setting the material properties section on Command Panel (Mode — **Material**, Entity — **Materials Management**).

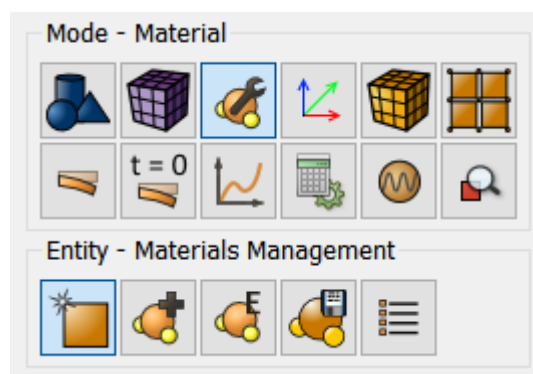

In the Materials Management window that opens, in the second column, click on the caption Enter the name of the material and write “Material 1”. Press the ENTER key.

In the left column, select Elasticity - Hooke Material. Select with the mouse the characteristic Young's modulus. Hold down the left mouse button and drag the label to Material Properties. Double-click in the Value field next to Young's modulus and enter the number 30e6. Similarly, from the Hooke Material section add the Poisson Ratio 0.3;

Click **Apply**.

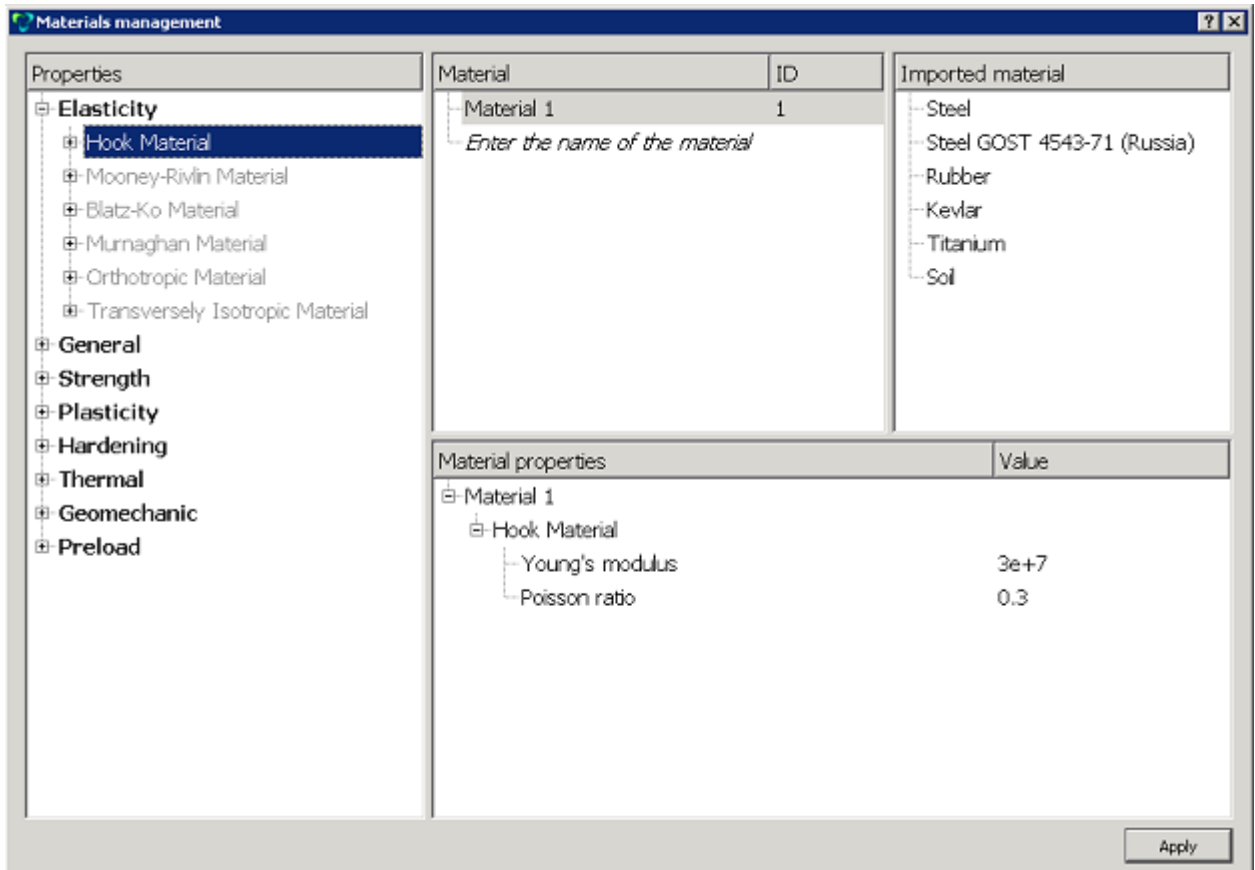

2. Create the block of one type of the material.

Select setting the material properties section on Command Panel (Mode — **Blocks**, Entity — **Block**, Action — **Add**).

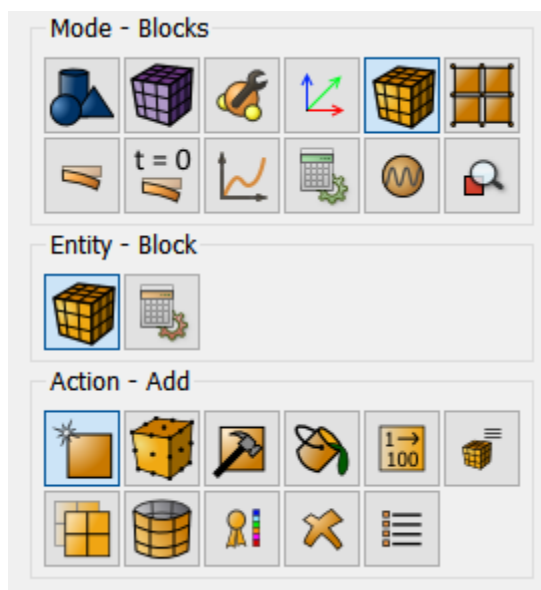

Set the following parameters:

- Block ID: 1;
- Entity List: Curve;
- Entity ID(s): 1 2 (*or by the command all*).

Click **Apply**.

3. Set the block parameters.

On the command panel, select the mode for setting material properties (Mode - **Blocks**, Entity - **Block**, Action - **Block properties/parameters**).

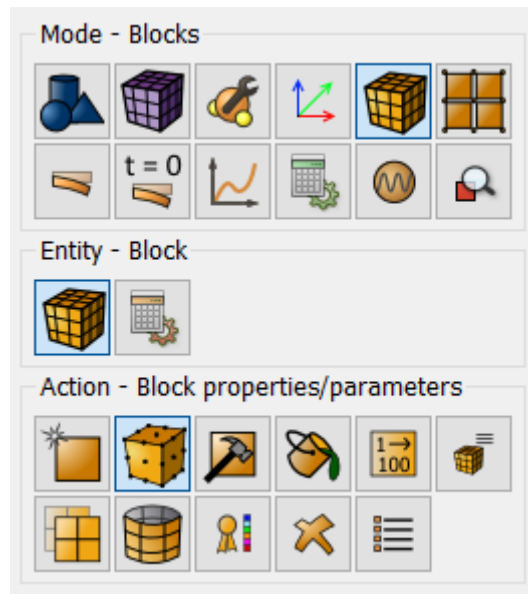

Set the following parameters:

- Block ID(s): 1;
- Category: Beam;
- Material: Material 1;
- Coordinate System: Global Cartesian;
- Order: 1.

Click **Set Beam Properties**. Set the checkbox **Select profile**. Select **Rectangle** in the list of geometric elements. Specify the following parameters:

- Height (H): 1;
- Width (B): 1.

Click **Apply**.

Close the window **Set Beam Properties**.

Click **Apply**.

Starting calculation

1. Set the type of the problem to be solved.

Select calculation setting section on Command Panel (Mode — **Calculation Settings**, Calculation settings — **Static**, Static — **General**).

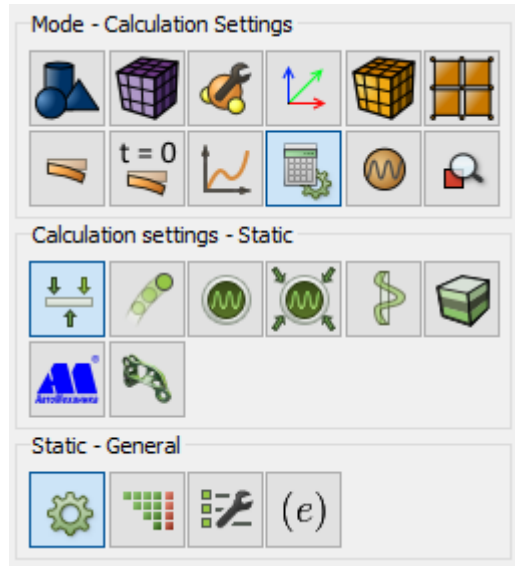

Select:

- Dimension: 3D;
- Model: Elasticity.

Click **Apply**.

2. Set the solver settings.

Select calculation setting section on Command Panel (Mode — **Calculation Settings**, Calculation settings — **Static**, Static — **Solver**).

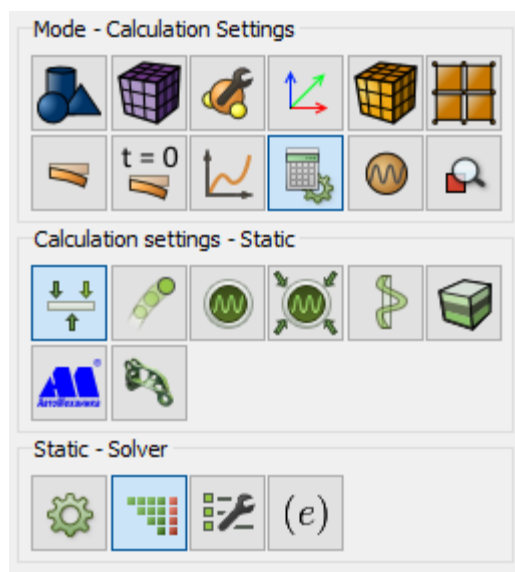

Select the solver method (direct or iterative) and set Convergence Parameters in case of choosing an iterative one. You can also leave all the settings by default.

Click **Apply**.

3. Set the reaction force calculation.

Select calculation setting section on Command Panel (Mode — **Calculation Settings**, Calculation settings — **Static**, Static — **OutputFields**).

Set the checkbox **Calculate nodal and reaction forces**.

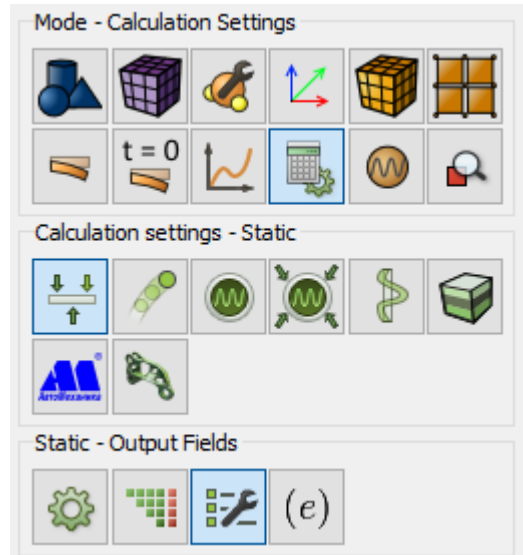

Click **Apply**.

Click **Start Calculation**.

Note: Without setting the checkbox **Calculate nodal and reaction forces**, the field is not calculated.

4. In a pop-up window select a folder to save the result and enter the file name.

5. If the calculation is finished successfully, you will see a message in the Console: “*Calculation finished successfully at <date> <time>*”.

Results analysis

1. Open the file with the results. There are three ways do this.

- Click Ctrl+E.
- Select **Calculation** → **Open Results** in the Main Menu. Click **Open last result**.
- Select **Results** on Command Panel (Mode — **Results**). Click **Open Results**.

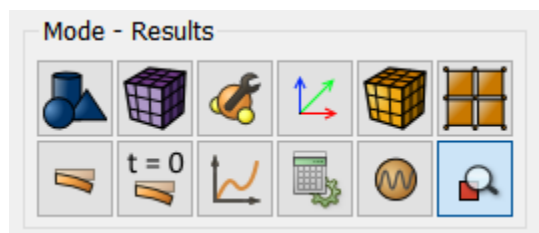

2. Display the u_y component of the displacements field.

In **Fidesys Viewer** window set the following parameters on Toolbar:

- Representation Mode: Surface;
- Representation Field: Displacement;
- Representation Component: Y.

The field of displacements distribution along the Y axis will be displayed on the model.



3. Check the numerical value of the reaction force at the point A.

Display Component 2 of the Reaction Forces field.



On the **Fidesys Viewer** Main Panel, click Select Points On surface.



Select the limiting left point (point A) on the geometric model.

To quickly view the information at the fixed point, click **pointsInfo** on the Main Panel.



In the pop-up window, components of the reaction force at the selected point will be displayed.

Node ID	X	Y	Z	Reaction Force
1	0	0	0	0 150.977 0

The difference between the resulting value 150.977 and the required 148.15 is less than 1,8%.

Do not close the window Points information.

4. Check the numerical value of reaction moments at the point C.

Display Component Z of the Reaction_moment field.



On the **Fidesys Viewer** Main Panel, click Select Points On surface.



Select the limiting right point C on the geometric model.

In the window Points information components of the reaction moment at the selected point will be displayed.

Node ID	X	Y	Z	Reaction Moment
3	150	0	0	0 0 -27353.5

The difference between the resulting value -27353.5 and the required -27377.3 is less than 0.01%.

5. Open 3D-image of the beam.

To display 3D-view of the beam cross section, set the focus on the calculation title and click the button  in the **Fidesys Viewer** standard line.



To apply all of the filters changes automatically, click **Apply changes to parameters automatically** on Command Panel.

6. Download numerical data.

Select **File** → **Save Data** in the Main Menu or click **Ctrl+S**. Enter the file name (*.csv format), leave it by default. Click **OK**. The saved file is an ordinary table of numerical data, any text editor can open it.

Using Console Interface

For geometry generation, meshing, setting boundary conditions and materials you can use Console Interface.



It is also possible to run the file *static_solid_beam.jou* by selecting Journal Editor on Toolbar. In a pop-up window of the main menu select **File** → **Open** and open the necessary journal file.

Static load (shell)

Timoshenko S.P. Voynovskiy-Kriger S. Plates and shells, Nauka, Moscow, 1966, 636 pages [in Russian]

We solve the problem of static load of square shell the two sides of which are clamped and the other two are freely supported. The picture represents a geometric model of the problem: $a = 1$ m, shell thickness is 0.1 m. The boundary conditions are presented in the picture. The plate is loaded by uniform pressure of 10 kPa.

Test pass criterion is the following: the maximum deflection is $1.19e-6$, moments $M_x=252$ N·m and $M_y=332$ N·m.

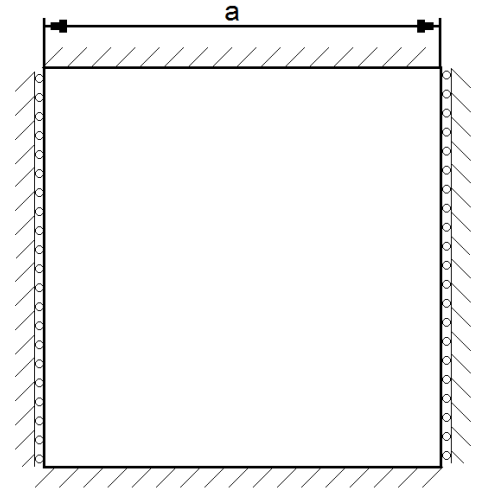

Geometry creation

1. Create the square 1 m on side.

Select volume geometry generation section on Command Panel (Mode - **Geometry**, Entity - **Surface**, Action - **Create**).



Select **Rectangle** in the list of geometric elements. Set the parameters:

- Width: 1;
- Height: Optional.

Click **Apply**.

Meshing

1. Select surface mesh generation section on Command Panel (Mode - **Mesh**, Entity - **Surface**, Action - **Mesh**).

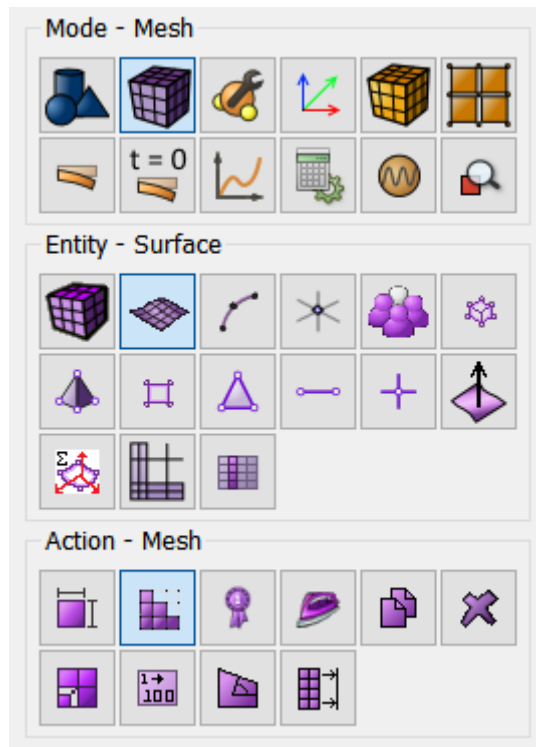

Specify the following parameters:

- Select meshing scheme: Polyhedron;
- Select Surfaces: 1.

Click **Apply Scheme**.

Click **Mesh**.

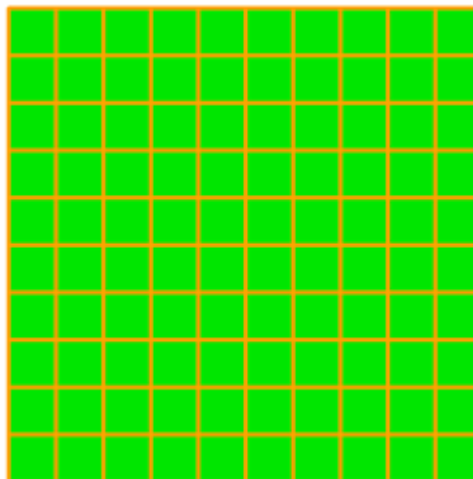

Setting boundary conditions

1. Fix the two edges rigidly.

Select surface mesh generation section on Command Panel (Mode - **Boundary Conditions**, Entity - **Displacement**, Action - **Create**).

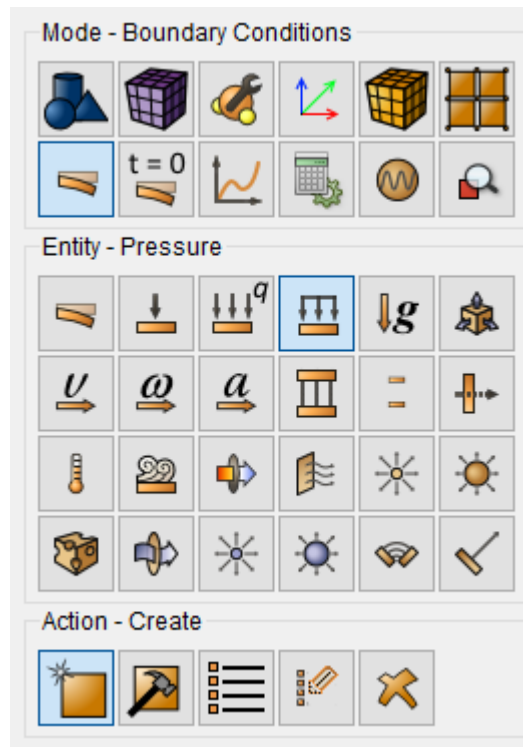

Set the following parameters:

- System Assigned ID;
- Entity List: Surface;
- Entity ID(s): 1;
- Magnitude Value: 1e4.

Click **Apply**.

Setting material and block properties

1. Create the material.

Select setting the material properties section on Command Panel (Mode - **Material**, Entity - **Materials Management**).

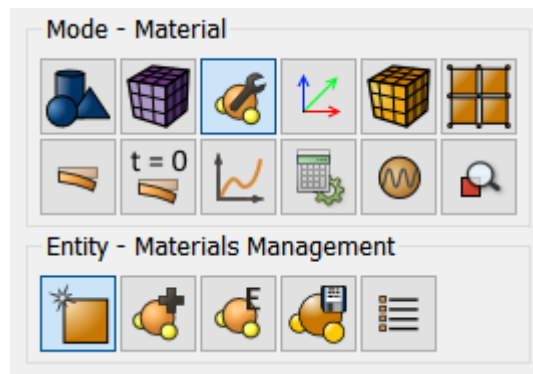

In the Materials Management window that opens, in the second column, click the caption “Enter the name of the material” and write “Material 1”. Press the ENTER key.

In the left column, select Elasticity - Hooke Material. Select with the mouse the characteristic Young's modulus. Hold down the left mouse button and drag the label to Material Properties. Double-click in the Value field next to Young's modulus and enter the number $2e11$. Similarly add the Poisson Ratio 0.3 from the Hooke Material section.

Click **Apply**.

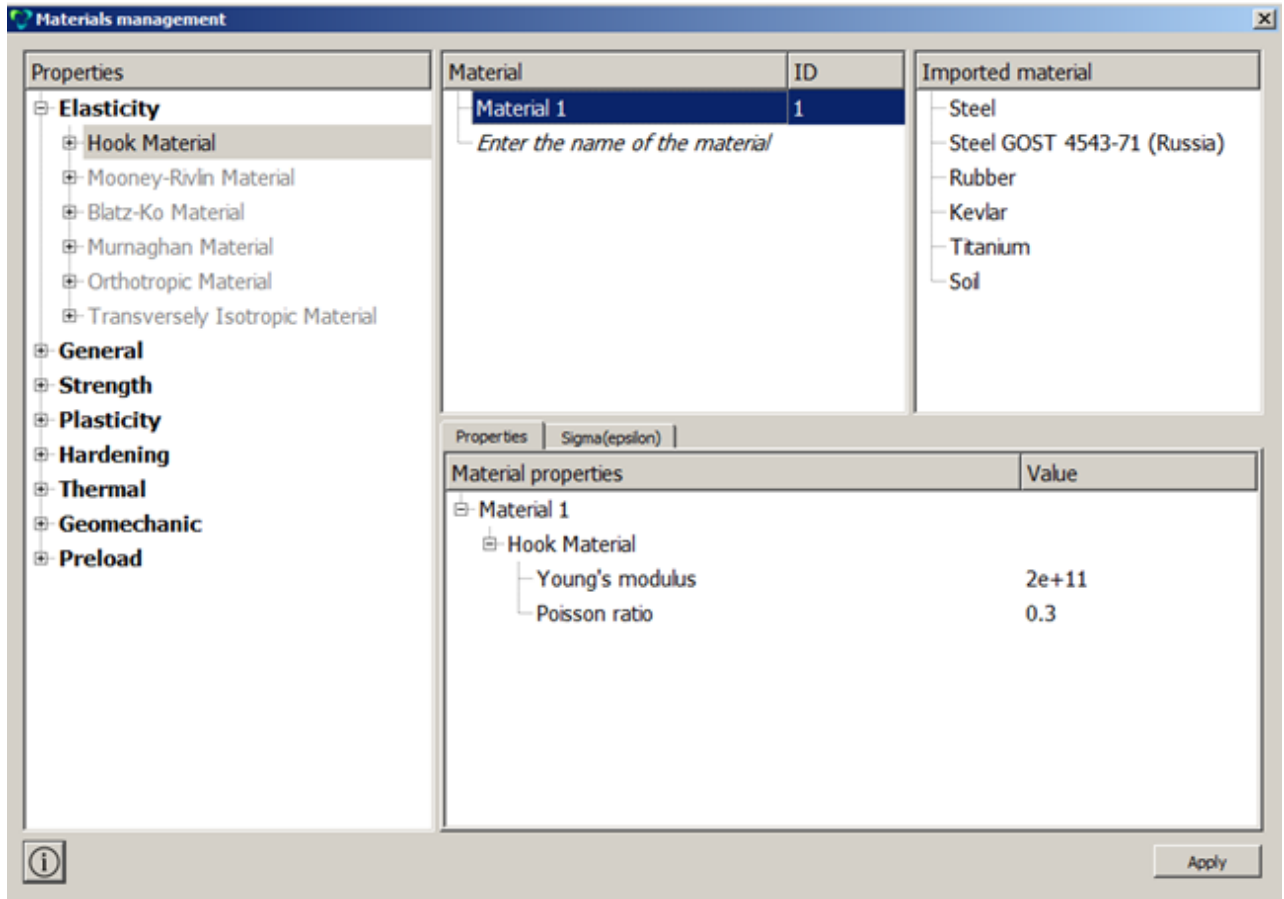

2. Create the block of one type of the material.

Select setting the material properties section on Command Panel (Mode - **Blocks**, Entity - **Block**, Action - **Add**).

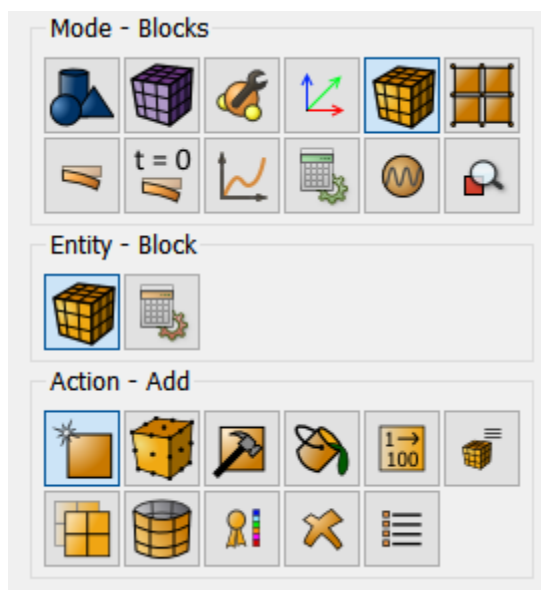

Set the following parameters:

- Block ID: 1;
- Entity List: Surface;
- Entity ID(s): 1 (*or by the command **all***).

Click **Apply**.

3. Set the block parameters.

On the command panel, select the mode for setting material properties (Mode - **Blocks**, Entity - **Block**, Action - **Block properties/parameters**).

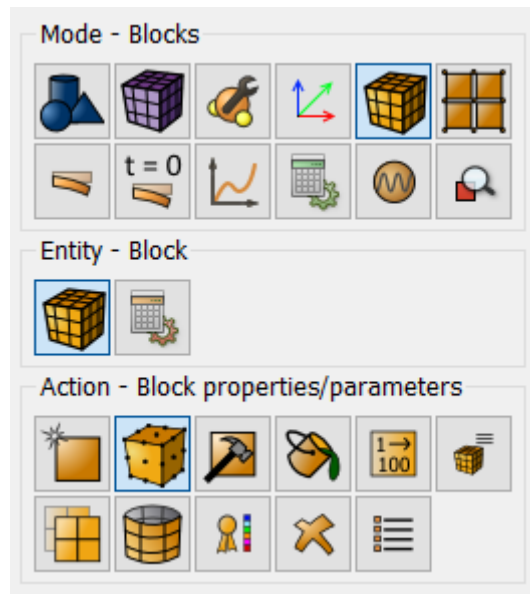

Set the following parameters:

- Block ID(s): 1;
- Category: Shell;
- Material: Material 1;
- Coordinate System: Global Cartesian;
- Order: 1.

Click **Set Shell Properties**. Set the following parameters:

- Thickness: 0.1;
- Eccentricity: 0.5.

Click **Apply**.

Close the window **Set Shell Properties**.

Click **Apply**.

Starting calculation

1. Set the type of the problem to be solved.

Select calculation setting section on Command Panel (Mode - **Calculation Settings**, Calculation settings - **Static**, Static - **General**).

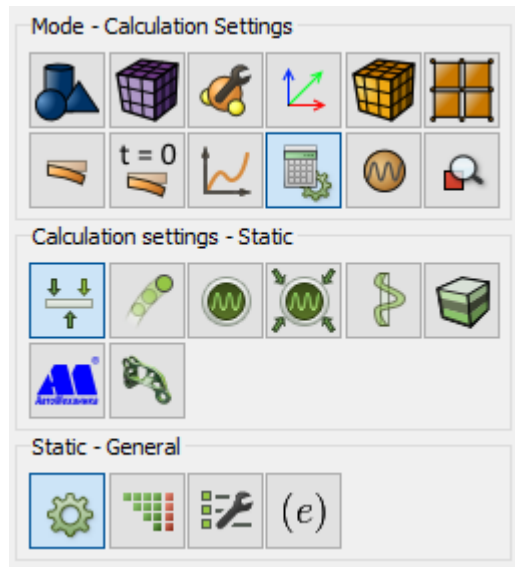

Select:

- Dimension: 3D;
- Model: Elasticity.

Click **Apply**.

2. Set the solver settings.

Select calculation setting section on Command Panel (Mode - **Calculation Settings**, Calculation settings - **Static**, Static - **Solver**).

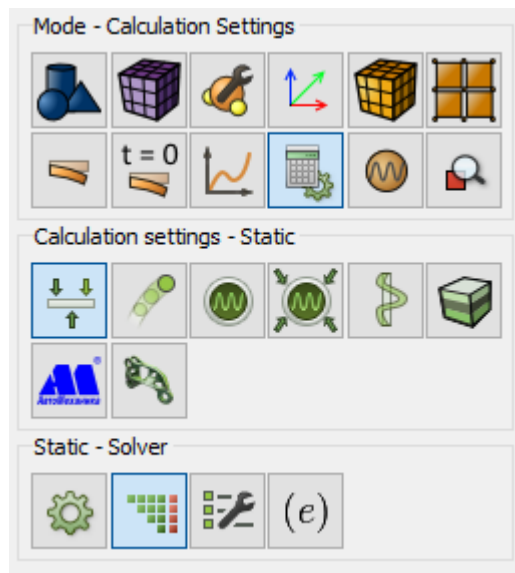

Select the solver method (direct or iterative) and set Convergence Parameters in case of choosing an iterative one. You can also leave all the settings by default.

Click **Apply**.

3. Set the reaction force calculation

Go to the tab Static - **Output fields** and set the checkbox **Calculate nodal and reaction forces**.

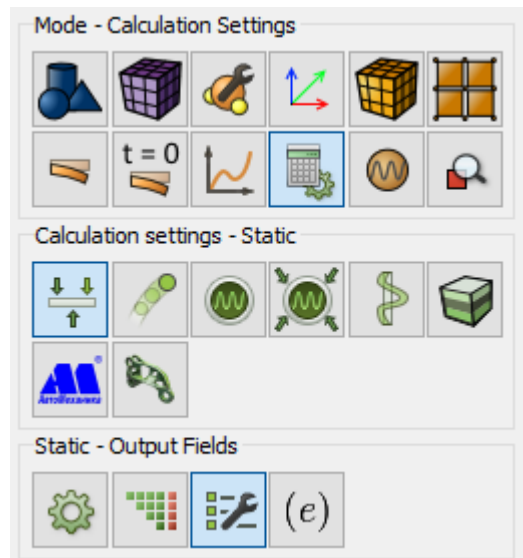

Click **Apply**.

Click **Start Calculation**.

Note: Without setting the checkbox **Calculate nodal and reaction forces**, the field is not calculated.

4. In a pop-up window select a folder to save the result and enter the file name.

5. If the calculation is finished successfully, you will see a message in the Console: "*Calculation finished successfully at <date> <time>*".

Results analysis

1. Open the file with the results. There are three ways to do it:

- Click Ctrl+E.
- Select Calculation - Open Results in the Main Menu. Click **Open last result**.
- Select **Results** on Command Panel (Mode - **Results**). Click **Open Results**.



2. Display the u_z component of the displacement field.

In **Fidesys Viewer** window set the following parameters on Toolbar:

- Representation Mode: Surface;
- Representation Field: Displacement;
- Representation Component: Z.



The field of displacements distribution along the Z axis will be displayed on the model.

3. Check the numerical value of the maximum displacement.

Display maximum Component 3 of the Displacement field.

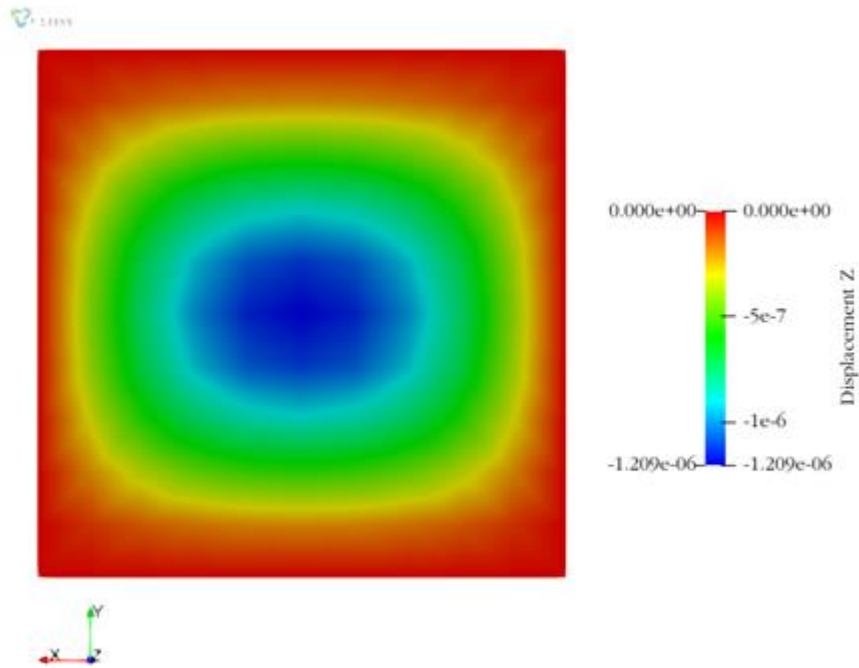

The difference between the resulting value 1.209×10^{-6} and the required -1.19×10^{-6} is 1.6%.

4. Check numeric values of moments in the center of the plate.

Display component XX of the MomentsShell field.



Select the filter **Probe Location** (Filters - Alphabetical - Probe Location) in the **Fidesys Viewer** Main Menu. In the tab **Properties** set the following values:

- Point: (0,0,0);
- Number of Points: 1;
- Radius: 0.

Go to the **Information** tab and look at the MomentsShell field.

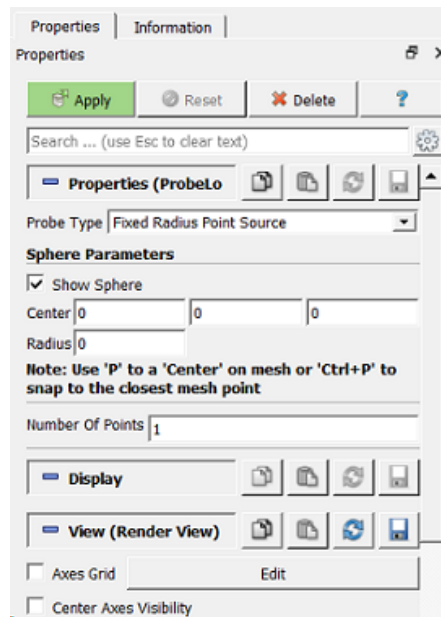

Showing	ProbeLocation1	Attribute:	Point Data	Precision:	6	.10
Point ID	0					
Block ID	1					
Displacement	-4.87036e-40; -1.04934e-40; -1.20893e-06					
External Force	0; 0; -100					
External Moment	0; 0; 0					
Global Element ID	1					
Material ID	1					
MiddleSurfaceForces	1.54244e-13; 2.76549e-13; 0; 3.2833e-14; 4.45572e-13; 1.52112e-12					
MomentsShell	260.347; 344.745; 0; -1.00345e-14; 0; 0					
Nodal Force	1.18329e-30; 0; -100					
Nodal Moment	1.06581e-14; -1.42109e-14; -9.62965e-34					
Node ID	41					
Normal	0; 0; 1					
Normal in Current	-3.67744e-22; 2.72882e-22; 1					
Parent ID	1					
Points	0; 0; 0					
Principal stress vector 1	1.02138e-11; 2.24675e-12; 1.06138e-11					
Principal stress vector 2	2.86582e-13; -1.34446e-12; 8.81944e-15					
Principal stress vector 3	1.07077e-11; 2.21176e-12; -1.07723e-11					
Reaction Force	0; 0; 0					
Reaction Moment	0; 0; 0					
Rotation	-2.72882e-22; -3.67744e-22; -1.74184e-24					
Strain	-7.00017e-25; -5.68148e-24; 2.73493e-24; 1.80305e-24; -8.11057e-24; 1.18552e-22; 1					
StrainBottomSide	4.7077e-07; 7.99923e-07; -5.44583e-07; -3.97935e-23; 9.77854e-24; 1.20301e-22; 9.3;					
StrainTopSide	-4.7077e-07; -7.99923e-07; 5.44583e-07; 4.12092e-23; 8.33414e-24; 1.21641e-22; 9.3;					

The difference between the resulting values ($M_x=260.347$ and $M_y=344.745$) and the required ($M_x=252$ and $M_y=332$) is 3.3% and 3.8%, relatively.

5. Open 3D-image of the shell.



To display 3D-view of the beam cross section, set the focus on the calculation title and click the button 3D-view in the Fidesys Viewer standard line.

The system will open a new file *.pvd and you will be able to apply various filters to it and to view its deformed view.

Choose the new file example_3D.pvd in the Model Tree and display Filters - Alphabetical - **Warp by Vector** for it with the following fields values.

- **Vectors:** Displacement;
- **Scale Factor:** 2e5.

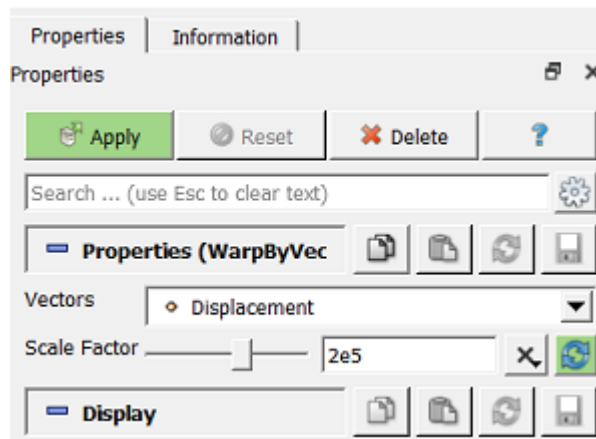

On the Toolbar, set once again the following parameters for the deformed type:



The first buckling mode will be displayed on the screen but the shell will be enveloped with thickness.

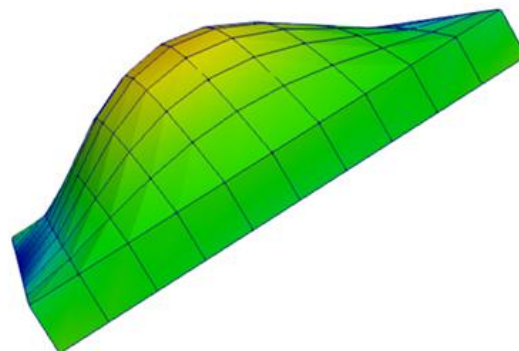

To apply all of the filters changes automatically, click **Apply changes to parameters automatically** on Command Panel.

6. Download numerical data

Select **File - Save Data** in the Main Menu or click **Ctrl+S**. Enter the file name (*.csv format), leave it by default. Click **OK**. The saved file is an ordinary table of numerical data which can be opened in any text editor.

Using Console Interface

For geometry generation, meshing, setting boundary conditions and materials you can use Console Interface.



It is also possible to run the file *static_gravity_shell.jou* by selecting Journal Editor on Toolbar. In a pop-up window of the main menu select **File** → **Open** and open the necessary journal file.

Hydrostatic pressure on cylinder (setting boundary conditions according to coordinates)

Societe Francaise des Mecaniciens, Guide de validation des progiciels de calcul de structures, (Paris, Afnor Technique, 1990.) Test No. SSLS08/89. I-Deas Model Solution Verification Manual

The problem of hydrostatic load of the cylindrical shell is being solved. The picture represents a geometric model of the problem: radius 1 m, shell thickness 0.02 m. The shell is fixed on the condition of the symmetry. The plate is loaded by the pressure $p = 20000 \cdot z/L$ Pa.

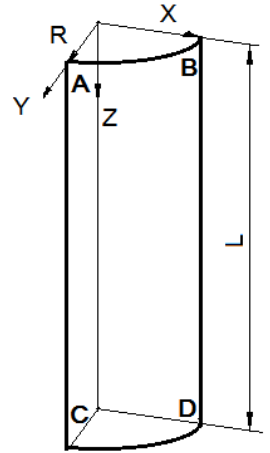

Test pass criterion is the following: displacement u_z at the point (0, R, L) is $2.86 \cdot 10^{-6}$ m.

Geometry creation

1. Create the cylinder of 1 m radius and 4 m high.

Select volume geometry generation section on Command Panel (Mode - **Geometry**, Entity - **Volume**, Action - **Create**).

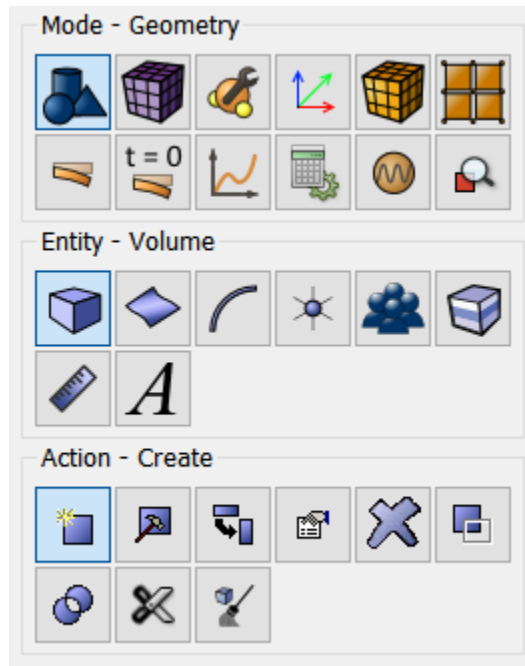

Select **Cylinder** in the list of geometric elements. Specify the cylinder dimensions:

- Height: 4;
- Cross section: Circular;
- Radius: 1.

Click **Apply**.

2. Get the cylindrical shell out of the volumeric cylinder.

Select the volume removing section on Command Panel (Mode - **Geometry**, Entity - **Volume**, Action - **Delete**).

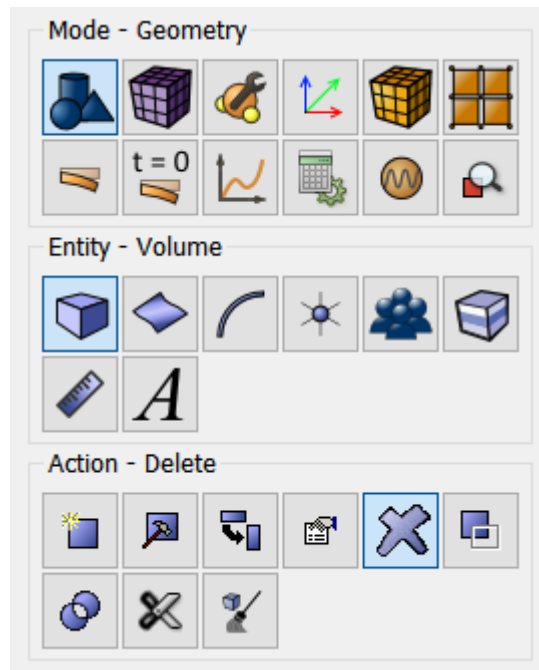

Enter the number of the created volume - 1 into the field **Volume ID(s)**.

Put a tick against **Keep Lower Geometry**.

Click **Apply**.

As a result, three plane bodies (Body 2, Body 3, Body 4) are obtained.

This will be displayed in the Model Tree.

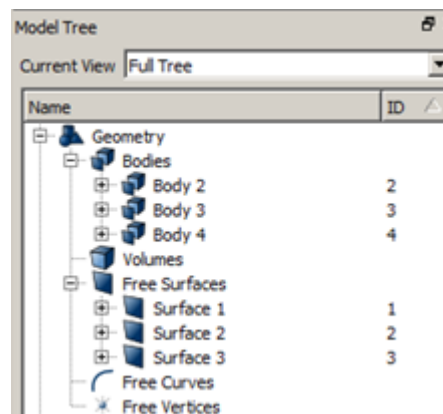

3. Delete side surfaces Surface 2 and Surface 3.

Select the surface removing section on Command Panel (Mode - **Geometry**, Entity - **Surface**, Action - **Delete**).

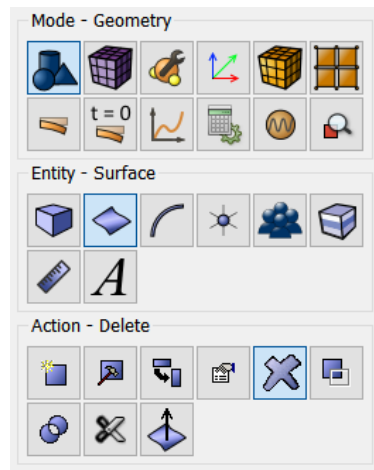

Enter numbers - 2 3 in the window **Surface ID(s)**.

Click **Apply**.

As a result, only the lateral cylindrical shell of 1 m radius and 4 m high will remain of the initial volume.

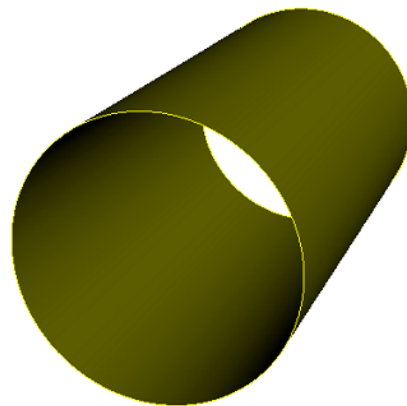
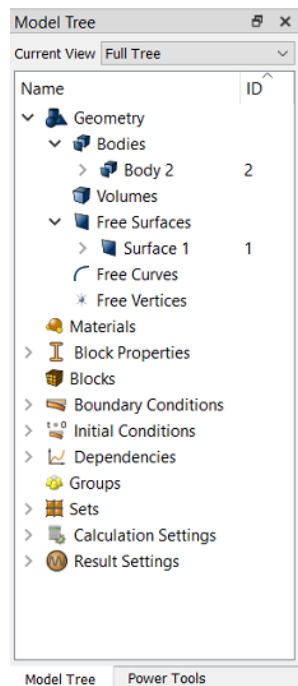

4. Leave a quarter of a shell (symmetric problem).

Select volume geometry generation section on Command Panel (Mode - **Geometry**, Entity - **Volume**, Action - **Webcut**).

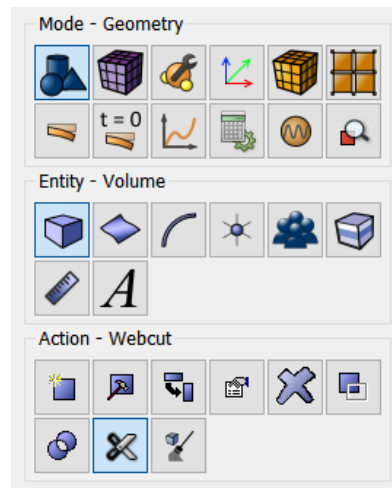

Select **Coordinate Plane** in the list of possible webcut types. Set the following parameters:

- Volume ID(s): 2 (*the body to be webcut*);
- Webcut with Plane: YZ;
- Offset Value: 0.

Click **Apply**.

Do the same for the ZX Plane.

- Volume ID(s): 2 (*the body to be webcut*);
- Webcut with Plane: ZX;
- Offset Value: 0.

Click **Apply**.

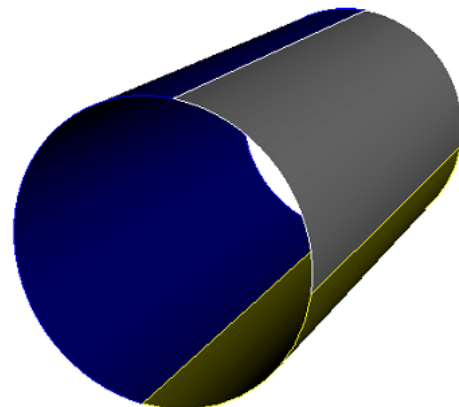
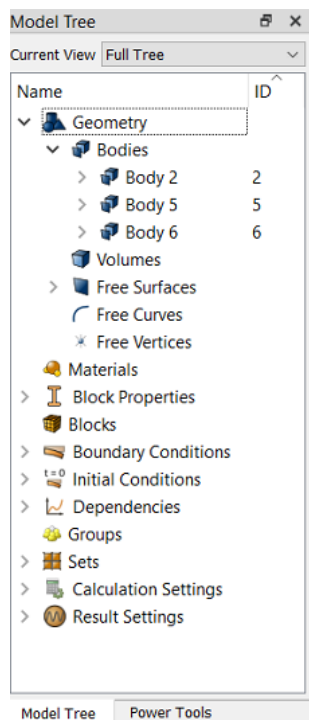

As a result, the original Body 2 in the Model Tree is split into three (Body 2, Body 5 and Body 6).

5. Delete surfaces Surface 5 and Surface 6.

Select the surface removing section on Command Panel (Mode - **Geometry**, Entity - **Surface**, Action - **Delete**).

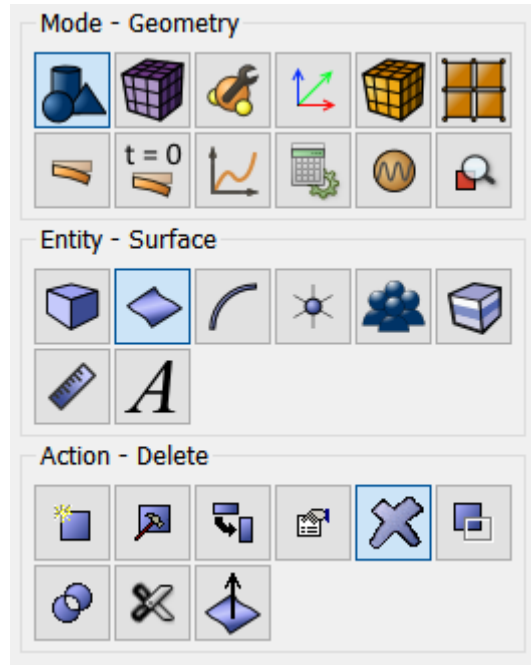

Enter numbers - 5 6 into the window **Surface ID(s)**.

Click **Apply**.

As a result, only a quarter of the original shell Body 6 (Surface 7) is left.

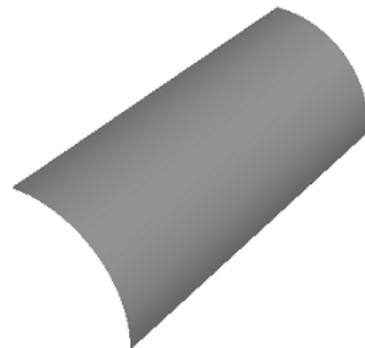
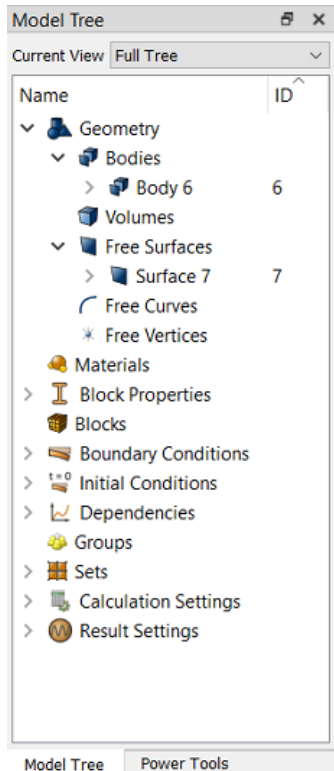

6. Move the surface to the coordinate origin.

Select surface geometry modification section on Command Panel (Mode - **Geometry**, Entity - **Surface**, Action - **Transform**).



Select **Move** in the list of possible webcut types. Set the following parameters:

- Surface ID(s): 7 (*the surface to be moved*);
- Select Method: Distance;
- Z Distance: 2.

Click **Apply**.

Meshing

1. Specify the parameters of mesh refinement.

Select meshing on curves section on Command Panel (Mode - **Mesh**, Entity - **Curve**, Action - **Mesh**).

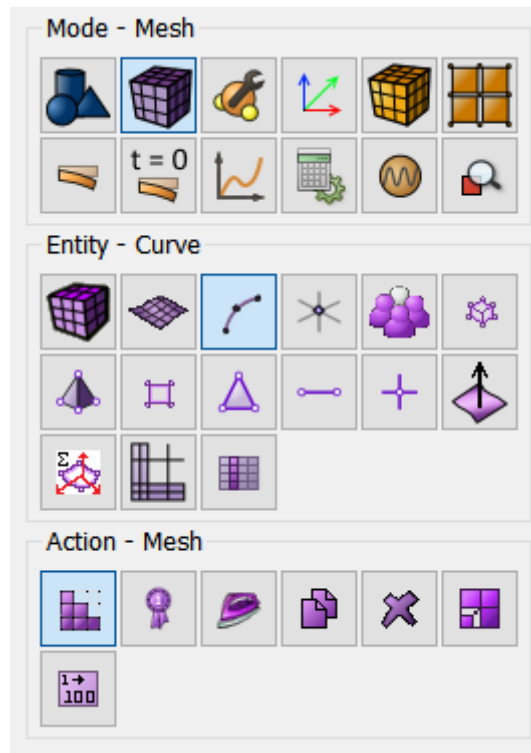

Split the cross-cut curves Surface 17 and Surface 18 into 10 elements.

- Select Curves: 17 18 (or click the mouse while holding down the Ctrl key on contour of the cross-cut curves);
- Select the way of meshing: Equal;
- Select splitting settings: Interval;
- Interval: 10.

Click **Apply Size**.

Split longitudinal curves Curve 5 and Curve 16 into 20 elements.

- Select Curves: 5 16 (or click the mouse while holding down the Ctrl key on contour of the longitudinal curves);
- Select the way of meshing: Equal;
- Select splitting settings: Interval;
- Interval: 20.

Click **Apply Size**.

2. Create the mesh.

Select the surface mesh generation section on Command Panel (Mode - **Mesh**, Entity - **Surface**, Action - **Intervals**).

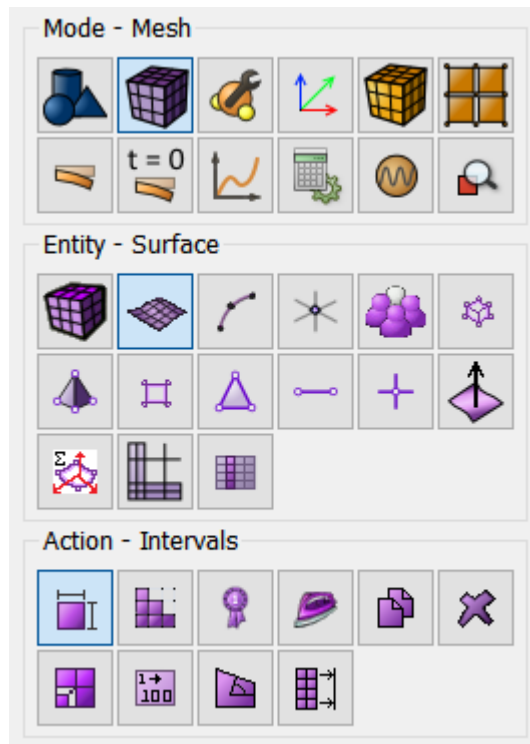

- Select meshing scheme: Automatic Sizing;
- Select Surfaces to Mesh (specify their ID): 7 (or by the command all).

Click **Apply Size**.

Click **Mesh**.

The resulting number of elements can be viewed in the Property Page by clicking on the inscription Surface 7 in the Model Tree on the left.

To view the mesh properties, you can follow these steps:

- Select the entire model;
- Right-click on the model;
- In the pop-up menu select List Information - List Mesh Info;
- Information on the mesh will be displayed in Command Line;

The screenshot displays the CAE Fidesys software interface. On the left, the **Model Tree** shows a hierarchy of objects: **Geometry** (containing **Bodies** and **Volumes**), **Free Surfaces** (containing **Surface 7**), **Free Curves**, and **Free Vertices**. Below this is the **Properties Page** for **Surface 7**, which lists various properties such as **ID**, **Name**, **Area**, and **Mesh** details. On the right, a 3D view shows a curved surface with a yellow mesh. Below the 3D view is a **Command Line** window displaying mesh statistics and a table of mesh information.

Mesh_Information			
Element_Type	Interior	Boundary	Total
Face	200	0	200
Edge	370	60	430
Node	171	60	231

Surface Area: 6.283195
Meshed Area: 6.276728

Displaying iso view
Current entity is Surface 7.

Fidesys>

Setting material and block properties

1. Create the material.

Select setting the material properties section on Command Panel (Mode - **Material**, Entity - **Materials Management**).

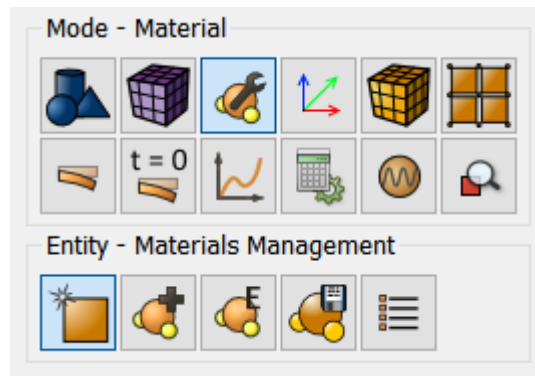

In the Materials Management window that opens, in the second column, click on the caption Enter the name of the material and write Material 1. Press the ENTER key.

In the left column, select Elasticity - Hooke Material. Select with the mouse the characteristic Young's modulus. Hold down the left mouse button and drag the label to Material Properties. Double-click in the Value field next to Young's modulus and enter the number 2.1e11. Similarly, from the Hooke Material section add the Poisson Ratio 0.3.

Click **Apply**.

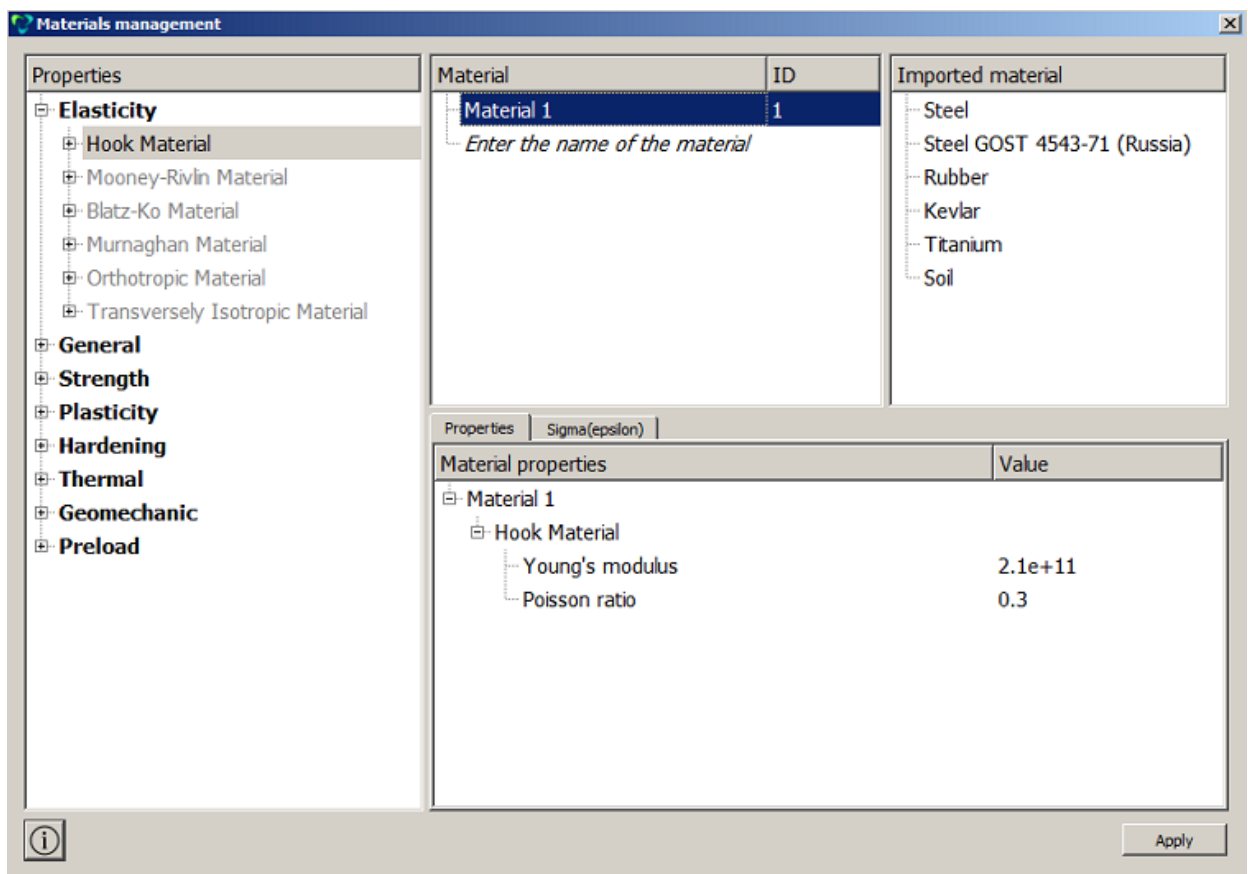

2. Create the block of one type of the material.

Select setting the material properties section on Command Panel (Mode - **Blocks**, Entity - **Block**, Action - **Add**).

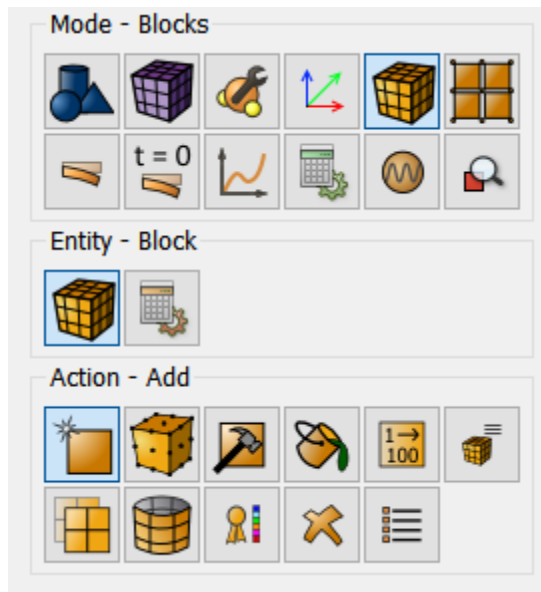

Set the following parameters:

- Block ID: 1;
- Entity List: Surface;
- Entity ID(s): 7 (or by the command all).

Click **Apply**.

3. Set the block parameters.

On the command panel, select the mode for setting material properties (Mode - **Blocks**, Entity - **Block**, Action - **Block properties/parameters**).

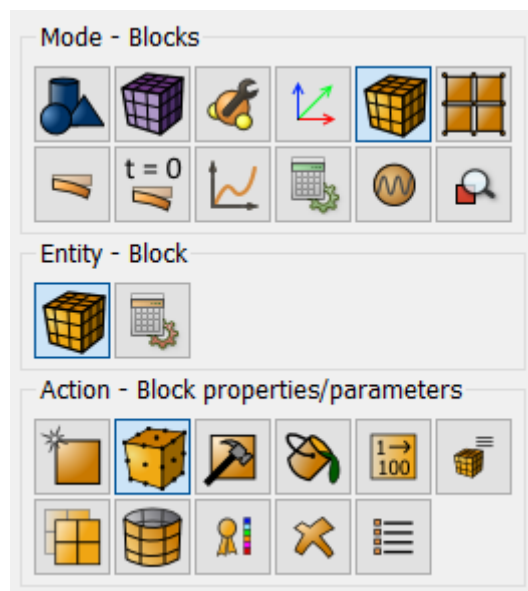

Set the following parameters:

- Block ID(s): 1;
- Category: Shell;

2. Fix the longitudinal curve Curve 5 on the symmetry condition.

Select on Command Panel (Mode - **Boundary Conditions**, Entity - **Displacement**, Action - **Create**).

Set the following parameters:

- System Assigned ID;
- Entity List: Curve;
- Entity ID(s): 5 (or click on the longitudinal curve);
- Degrees of Freedom: X-Translation Disp; Y-Rotation Disp; Z-Rotation Disp.

Click **Apply**.

3. Fix the longitudinal curve Curve 16 by the symmetry condition.

Select on Command Panel (Mode - **Boundary Conditions**, Entity - **Displacement**, Action - **Create**).

Set the following parameters:

- System Assigned ID;
- Entity List: Curve;
- Entity ID(s): 16 (or click on the longitudinal curve);
- Degrees of Freedom: Y-Translation Disp; X-Rotation Disp; Z-Rotation Disp.

Click **Apply**.

4. Apply pressure to the cylinder inner surface with value of 1.

Select on Command Panel (Mode - **Boundary Conditions**, Entity - **Pressure**, Action - **Create**).

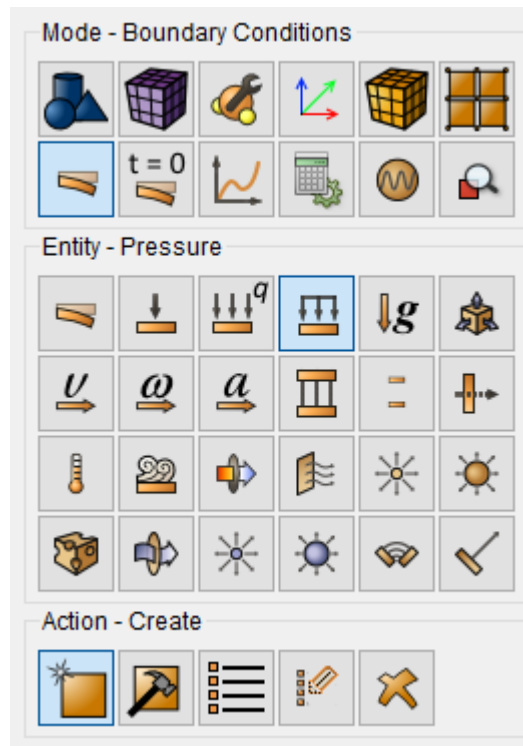

Set the following parameters:

- System Assigned ID;
- Pressure Entity List: Surface;
- Entity ID(s): 7 (or click on the cylinder surface);
- Magnitude Value: 1.

Click **Apply**.

5. Set pressure dependency of the z-coordinate. Select (Mode - **BC Dependency**).

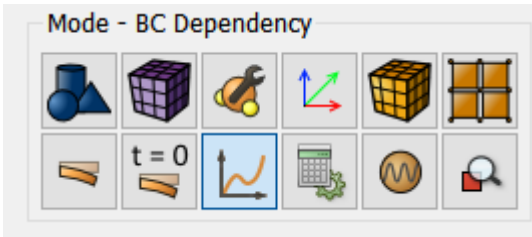

In the pop-up window **BC Dependency**, set the following parameters:

- BC name: Pressure 1;
- Select checkbox Formula, Manually;
- In the field below, enter $-20000*z/4$.

Click **Apply**.

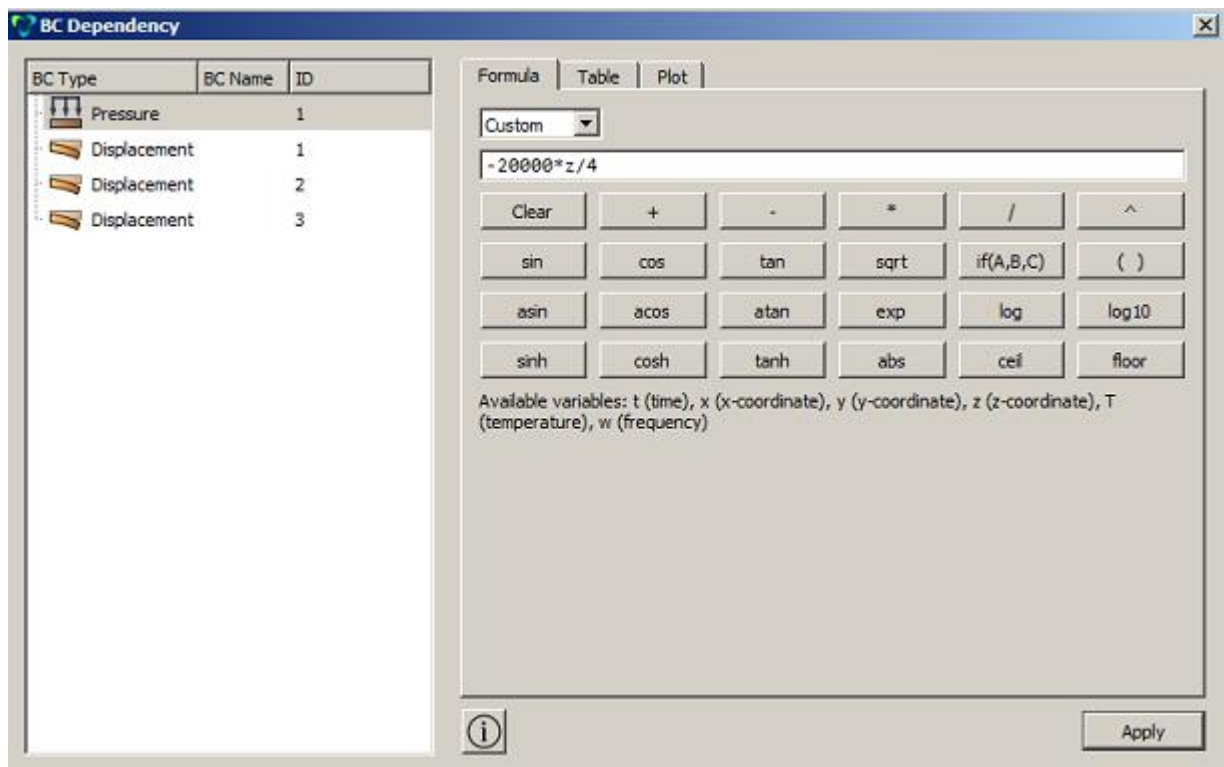

To view the plotted graph use the appropriate tab.

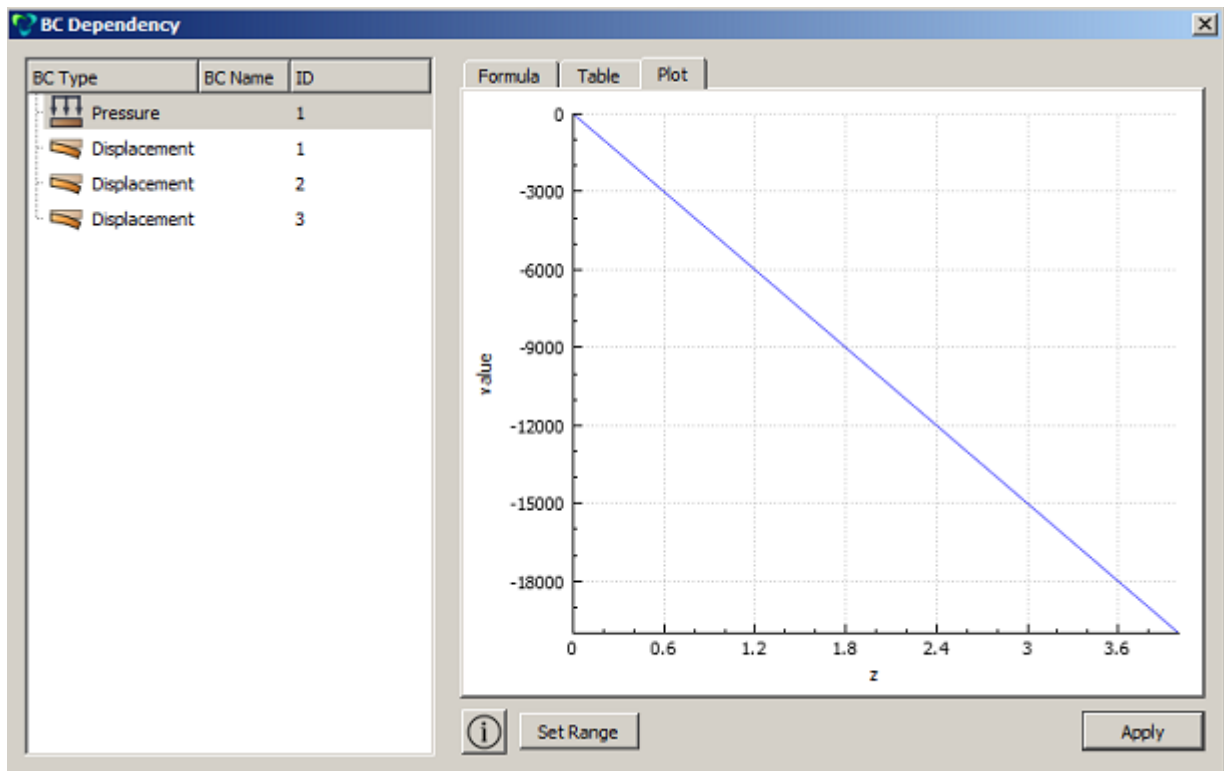

Starting calculation

1. Set the type of the problem to be solved.

Select calculation setting section on Command Panel (Mode - **Calculation Settings**, Calculation settings - **Static**, Static - **General**).

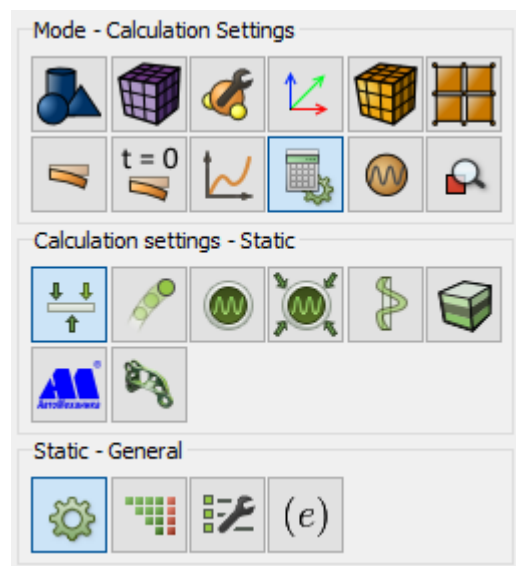

Select:

- Dimension: 3D;
- Model: Elasticity.

Click **Apply**.

Click **Start Calculation**.

In a pop-up window select a folder to save the result and enter the file name.

If the calculation is finished successfully, you will see a message in the Console: "*Calculation finished successfully at <date> <time>*" • .

Results analysis

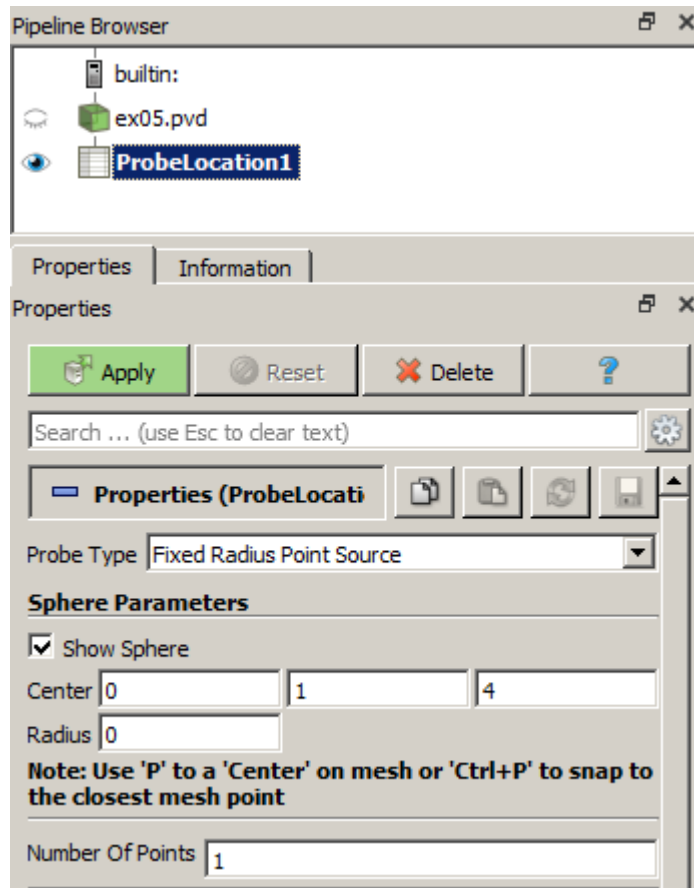

1. Open the file with the results. There are three ways to do it:

- Click Ctrl+E.
- Select **Calculation - Open Results** in the Main Menu. Click **Open last result**.
- Select **Results** on Command Panel (**Mode Results**). Click **Open Results**.



2. Display the U_z component of the displacement field on the model.

In **Fidesys Viewer** window set the following parameters on Toolbar:

- Representation Mode: Surface;

- Representation Field: Displacement;
- Representation Component: 3.

3. Compare the numerical value of the target displacement at the point (0,1,4) with the initial one of the source -2.86e-6.

Select **Filters - Alphabetical - Probe Location**. In the tab Properties, set the following parameters for the filter:

- Point (0, 1, 4);
- Number of Points: 1;
- Radius: 0.

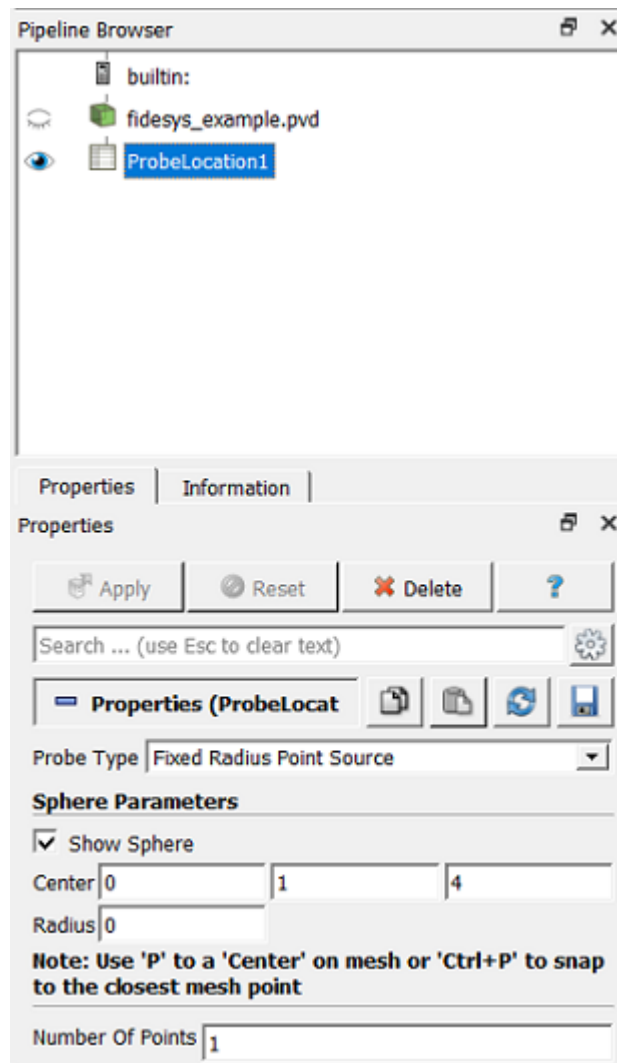

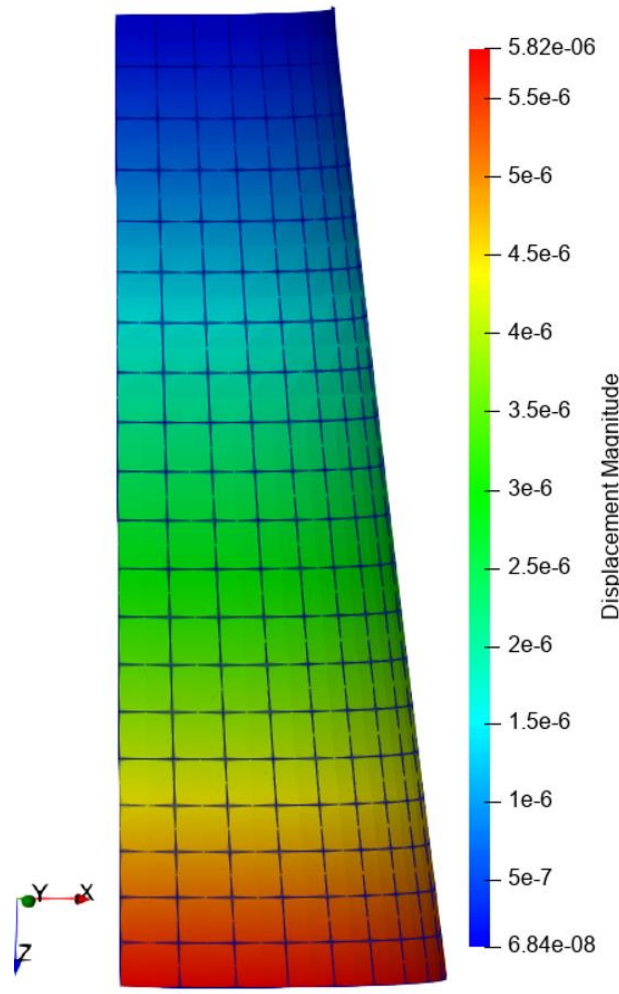

Consider the direction of the coordinate axes in the picture.

4. Download numerical data.

Select **File - Save Data** in the Main Menu or click **Ctrl+S**. Enter the file name (*.csv format), leave it by default. Click **OK**. The saved file is an ordinary table of numerical data which can be opened in any text editor.

Using Console Interface

For geometry generation, meshing, setting boundary conditions and materials you can use Console Interface.



It is also possible to run the file *static_shell_coord_dependence.jou* by selecting Journal Editor on Toolbar. In a pop-up window of the main menu select **File** → **Open** and open the necessary journal file.

Buckling (shell model)

S.P. Timoshenko, J.M. Manages "Theory of elastic stability" second edition. Dunod, 1966, 500 pages

We solve the problem of cylindrical shell buckling under the pressure uniformly distributed over the entire surface.

The picture represents a geometric model of the problem: $R = 2$ m, $L = 2$ m, thickness $h = 0.002$ m. Due to the symmetry of the problem, the $\frac{1}{4}$ part of the cylinder is regarded. Constraints on the lines AB and CD are due to the conditions of symmetry; a uniformly distributed load on the surface is ABCD $q = 1$ kPa. The material parameters are $E = 200$ GPa, $\nu = 0.3$.

It is necessary to compare the first three critical values.

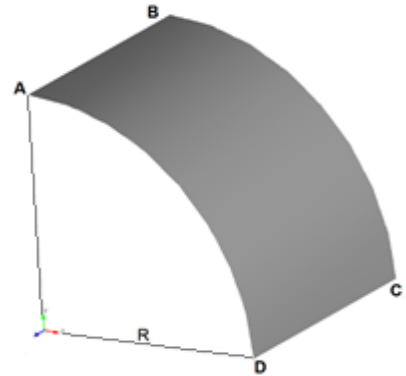

Geometry creation

1. Create a cylinder with radius of 2 m and length of 2 m.

Select volume geometry generation section on Command Panel (Mode — **Geometry**, Entity — **Volume**, Action — **Create**).



Select **Cylinder** in the list of geometric elements. Create leaving **Circular** at the base.

Set radius of 2 and height of 2.

Click **Apply**.

2. Get the cylindrical shell out of the volumeric cylinder.

Select the volume removing section on Command Panel (Mode — **Geometry**, Entity — **Volume**, Action — **Delete**).

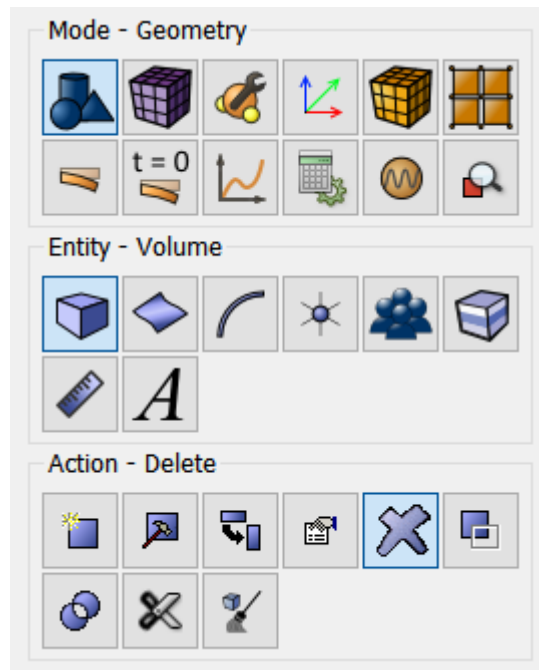

Enter the number of the created volume – 1 into the field **Volume ID(s)**. Put a tick against **Keep Lower Geometry**.

Click **Apply**.

As a result, three plane bodies (Body 1, Body 2, Body 3) are obtained. This will be displayed in the Model Tree.

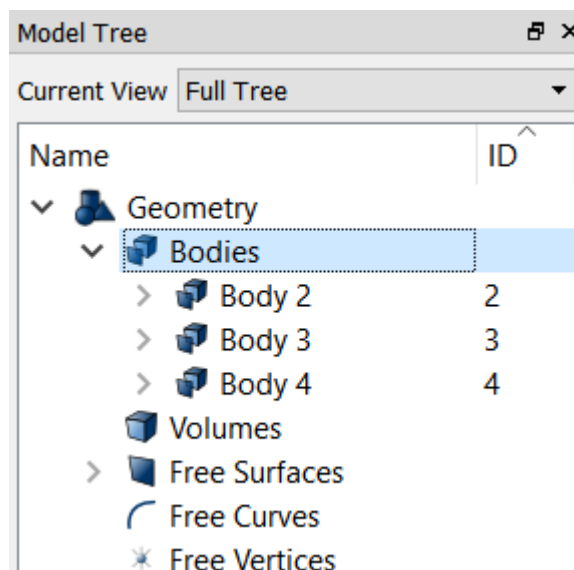

3. Delete side surfaces Body 3 and Body 4.

Select the surface removing section on Command Panel (Mode — **Geometry**, Entity — **Surface**, Action — **Delete**). Enter numbers 2 3 in the window **Surface ID(s)**.

Click **Apply**.

As a result, only the lateral cylindrical shell of 2 m radius and 2 m high will remain of the initial volume.

4. Leave a quarter of a shell (symmetry of the problem).

Select volume geometry generation section on Command Panel (Mode — **Geometry**, Entity — **Surface**, Action — **Webcut**).

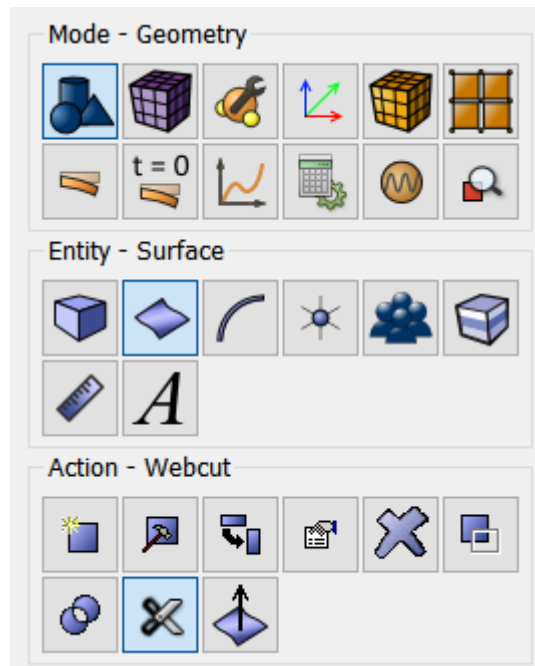

Select **Coordinate Plane** in the list of possible webcut types. Set the following parameters:

- Body ID(s): 2 (*the surface to be webcut*);
- Webcut with Plane: YZ;
- Offset Value: 0;
- Imprint.

Click **Apply**.

Do the same for the ZX Plane:

- Body ID(s): 2 (*the volume to be webcut*);
- Webcut with Plane: ZX;
- Offset Value: 0;
- Imprint.

Click **Apply**.

As a result, the original volume in the Model Tree is split into three (Body 2, Body 5 and Body 6).

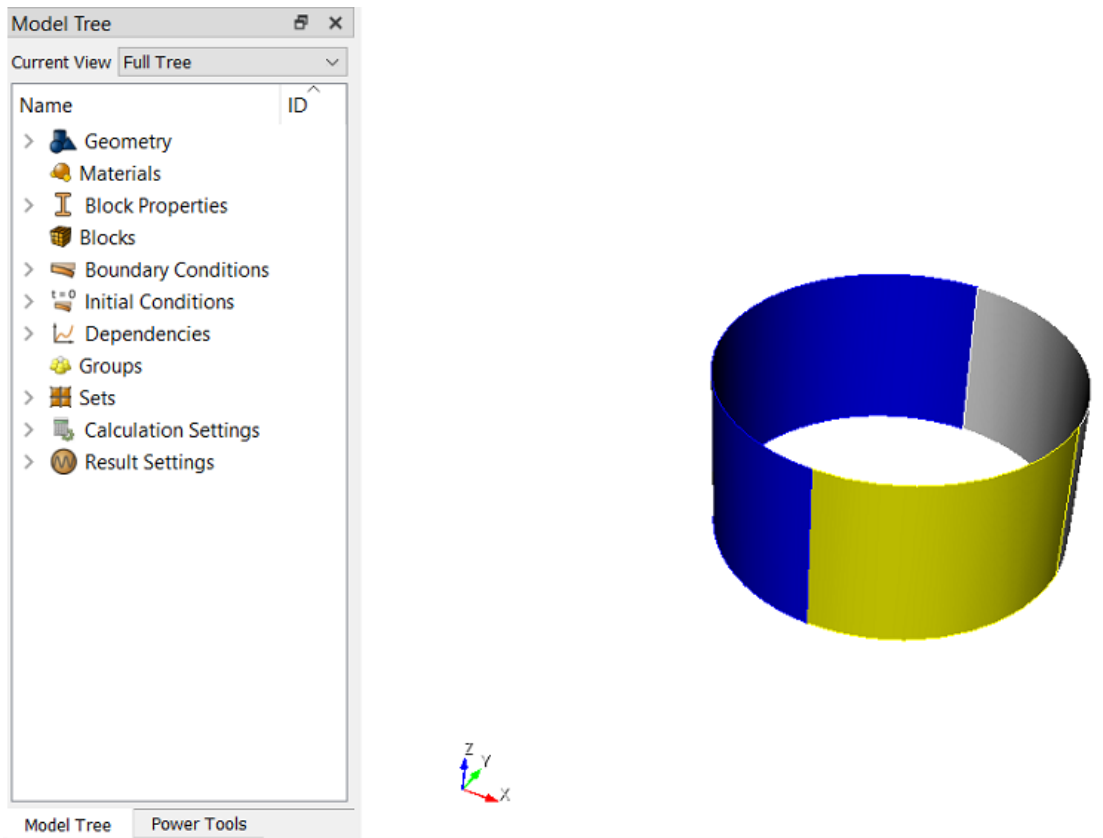

Delete the bodies 2 and 5. To do this select these bodies in the Model Tree holding down the Ctrl key and click **Delete** in contextual menu. As a result, a quarter of the original shell is left (Body 6):

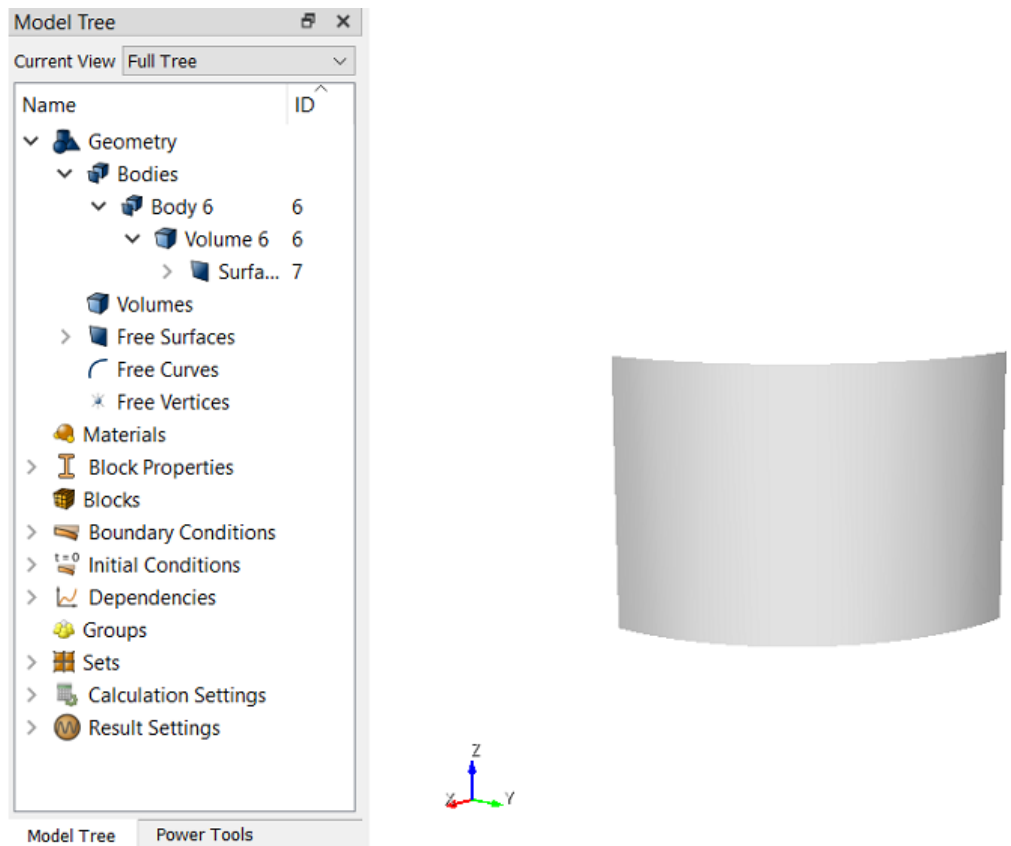

Meshing

1. Create a quadrangular mesh.

Select meshing on plane section on Command Panel (Mode — **Mesh**, Entity — **Surface**, Action — **Intervals**).

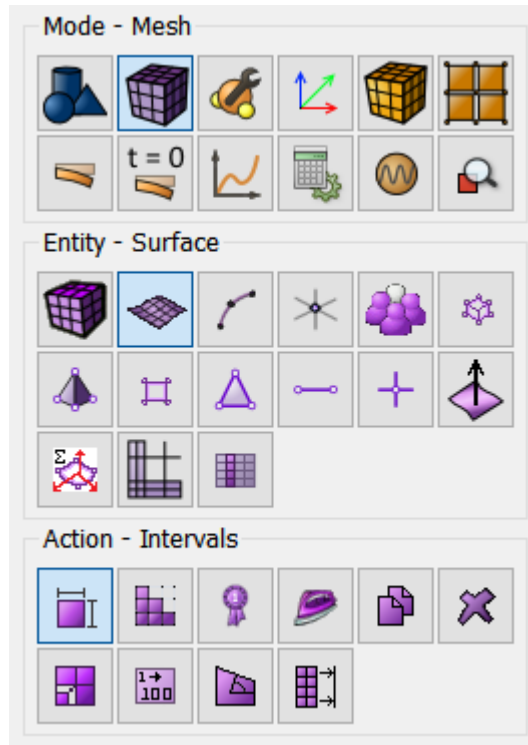

Specify the parameters of mesh refinement:

- The way of meshing: Approximate Size;
- Select Surfaces: 7;
- Approximate Size: 0.125.

Click **Apply Size**.

2. Select meshing on plane section on Command Panel (Mode — **Mesh**, Entity — **Surface**, Action — **Mesh**).

Select meshing scheme:

- Select meshing scheme: Polyhedron;
- Select Surfaces: 7.

Click **Apply Scheme**.

Click **Mesh**.

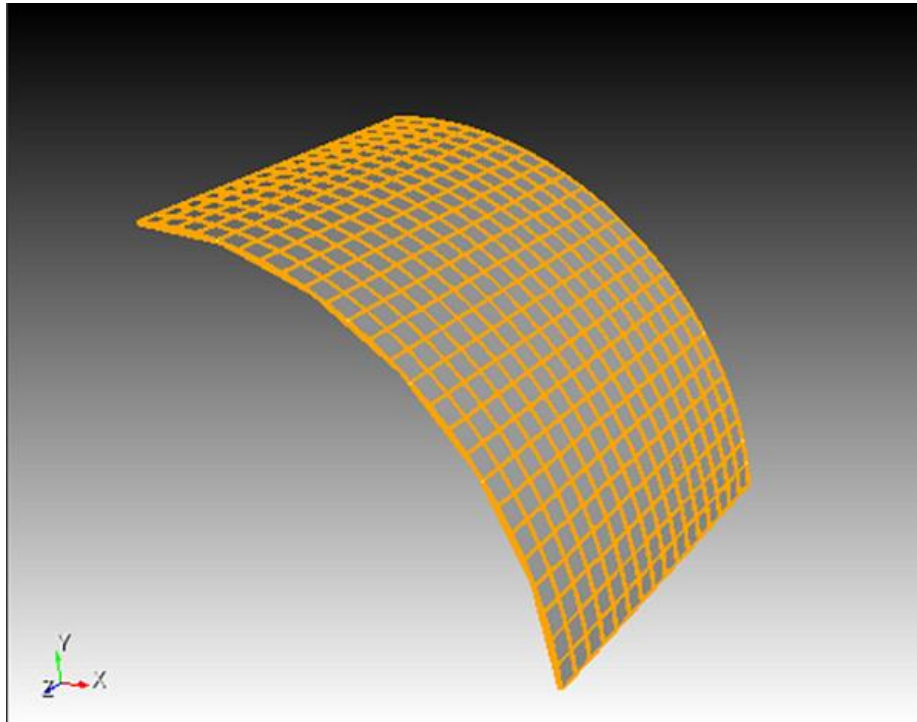

Setting boundary conditions

1. Fix the line AB on the conditions of symmetry.

Select meshing on plane section on Command Panel (Mode — **Boundary Conditions**, Entity — **Displacement**, Action — **Create**).

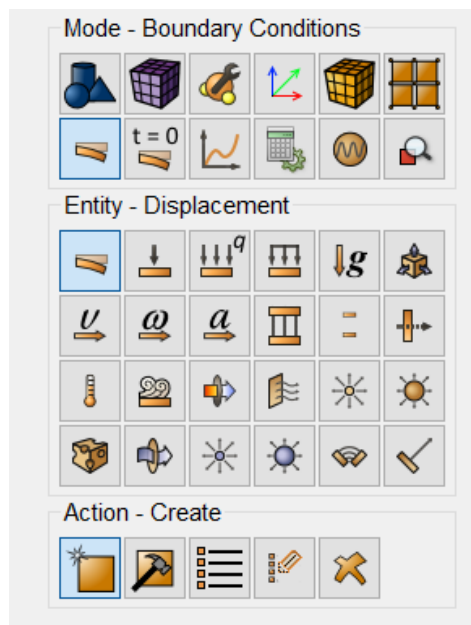

Set the following parameters:

- System Assigned ID;
- Entity List: Curve;
- Entities ID(s): 5 (or click on the top line on a quarter of the shell);

- Degrees of Freedom: X-Translation Disp, Y-Rotation Disp, Z-Rotation Disp;
- DOF Value: 0.

Click **Apply**.

2. Fix the line CD of the conditions of symmetry.

Select meshing on plane section on Command Panel (Mode — **Boundary Conditions**, Entity — **Displacement**, Action — **Create**).

- System Assigned ID;
- Entity List: Curve;
- Entity ID(s): 16 (or click on the lower line on a quarter of the shell);
- Degrees of Freedom: Y-Translation Disp, X-Rotation Disp, Z-Rotation Disp;
- DOF Value: 0.

Click **Apply**.

3. Apply pressure to the entire surface of the shell.

Select meshing on plane section on Command Panel (Mode — **Boundary Conditions**, Entity — **Pressure**, Action — **Create**). Set the following parameters:

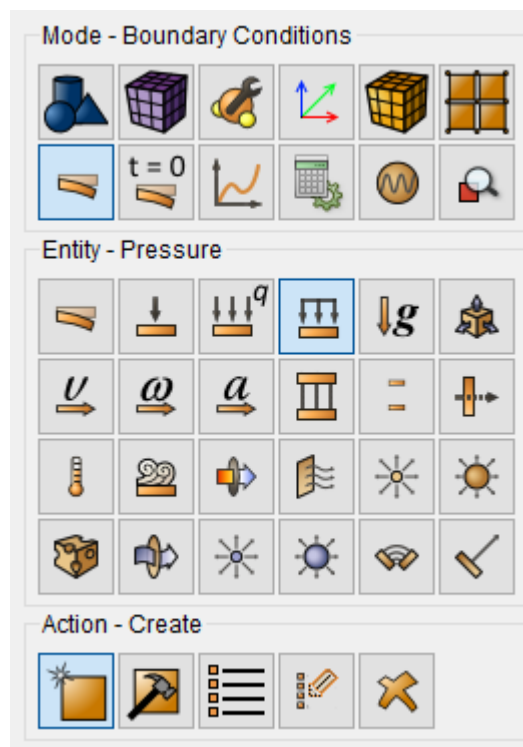

- System Assigned ID;
- Pressure Entity List: Surface;
- Entity ID(s): 7;
- Magnitude Value: 1000.

Setting material and block properties

1. Create the material.

Select setting the material properties section on Command Panel (Mode — **Material**, Entity — **Materials Management**).

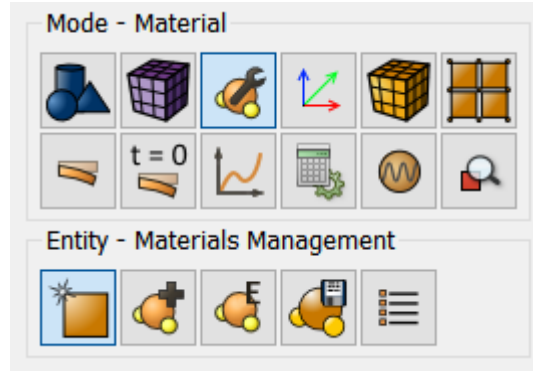

In the Materials Management window that opens, in the second column, click on the caption Enter the name of the material and write “Material 1”. Press the ENTER key.

In the left column, select Elasticity - Hooke Material. Select with the mouse the characteristic Young's modulus. Hold down the left mouse button and drag the label to Material Properties. Double-click in the Value field next to Young's modulus and enter the number $2e11$. Similarly, from the Hooke Material section add the Poisson Ratio 0.3.

Click **Apply**.

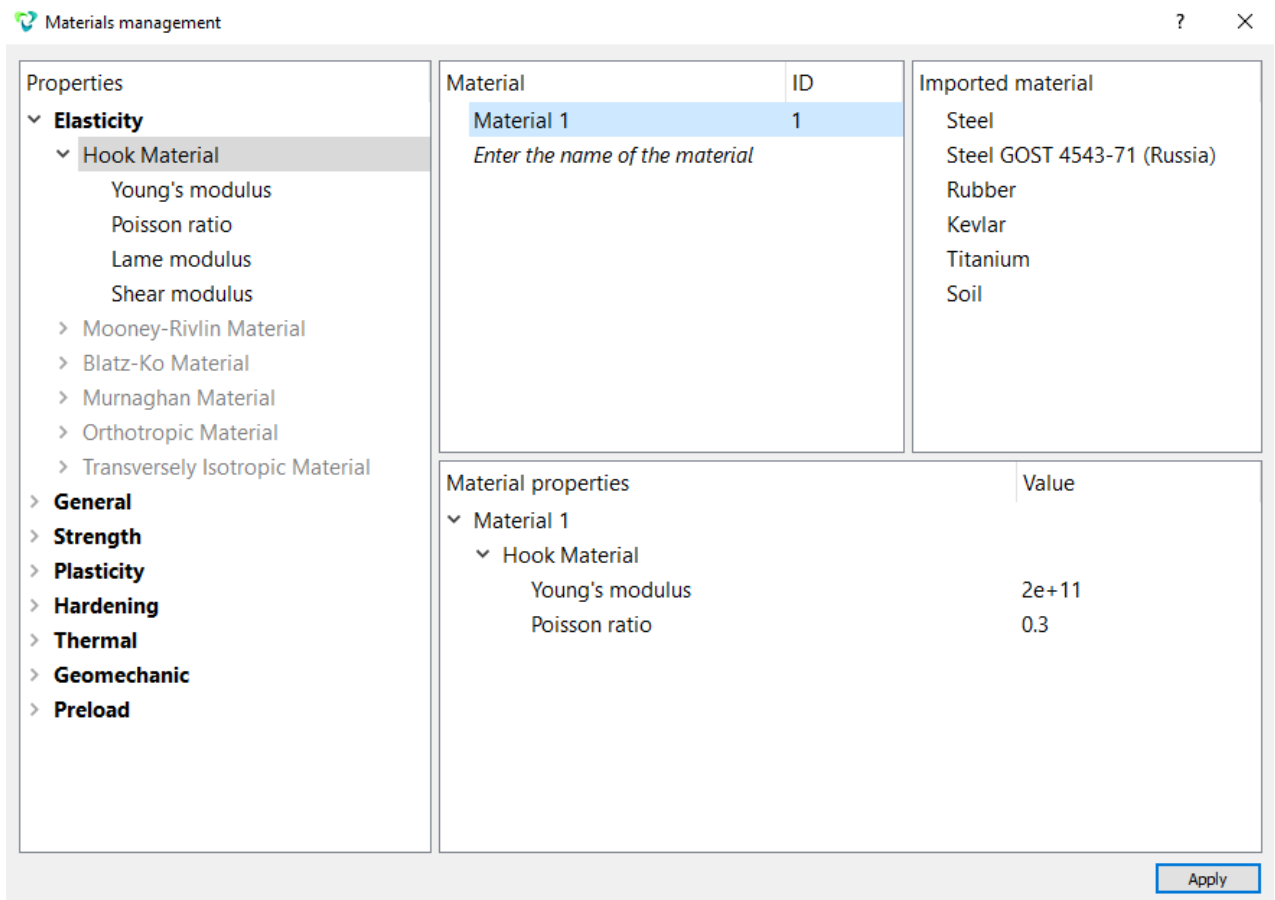

2. Create a block of one type of the material.

Select setting the material properties section on Command Panel (Mode — **Blocks**, Entity — **Block**, Action — **Add**).

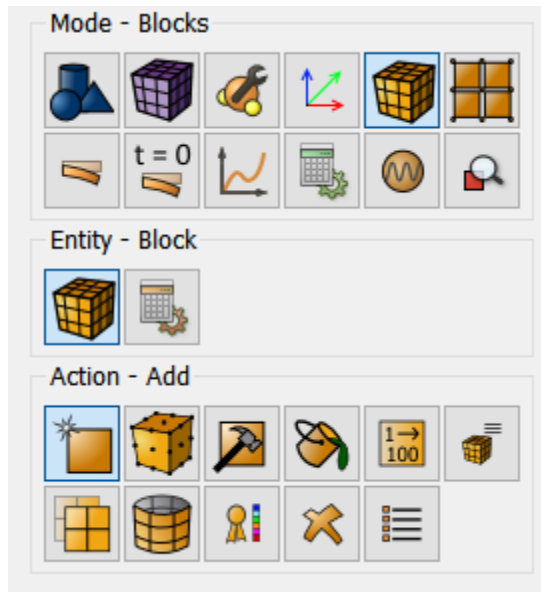

Set the following parameters:

- Block ID: 1;
- Entity List: Surface;
- Entity ID(s): 7 (or by the command all).

Click **Apply**.

3. Set the block parameters.

On the command panel, select the mode for setting material properties (Mode - **Blocks**, Entity - **Block**, Action - **Block properties/parameters**).

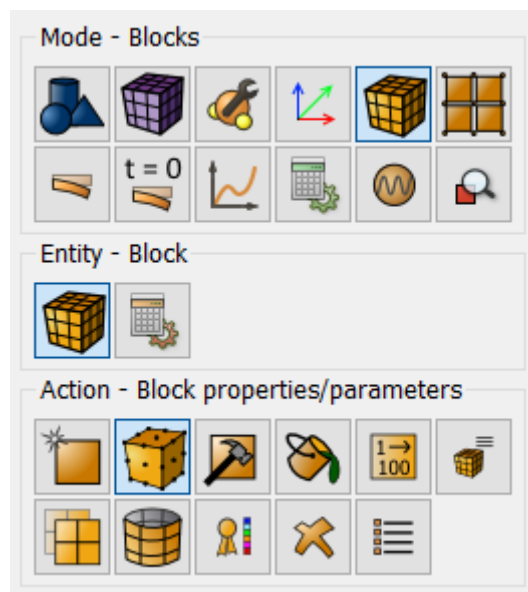

Set the following parameters:

- Block ID(s): 1;

- Category: Shell;
- Material: Material 1;
- Coordinate System: Global Cartesian;
- Order: 1.

Click **Set Shell Properties**. Set the following parameters:

- Thickness: 0.02;
- Eccentricity: 0.5.

Click **Apply**.

Close the window **Set Shell Properties**.

Click **Apply**.

Starting calculation

1. Set the type of the problem to be solved.

Select calculation settings section on Command Panel (Mode — **Calculation Settings**, Calculation settings — **Buckling**, Stability — **General**).

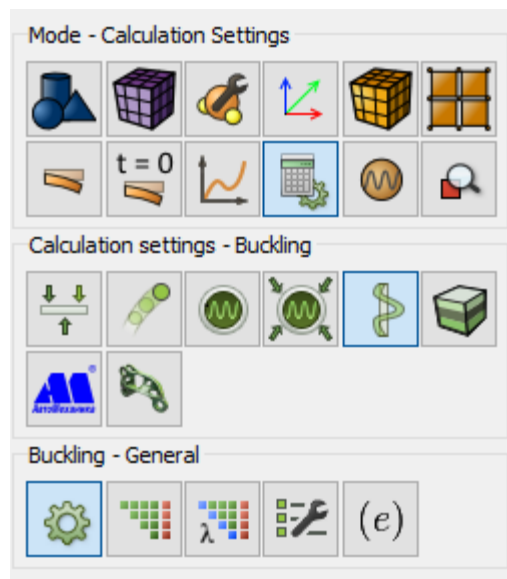

Select 3 in the field **Number of buckling modes**. Leave other parameters by default.

Click **Apply**.

Click **Start Calculation**.

In a pop-up window select a folder to save the result and enter the file name.

If the calculation is finished successfully, you will see a message in the Console: “*Calculation finished successfully at <date> <time>*”.

Results analysis

1. Compare the obtained results.

The first three critical values are displayed in Command Line.

```
Command Line
WARNING: Model is not fixed along Z direction.
Step 1. SubStep 1. Load time 1.00000000. Load step 1.00000000e+00. Done. Successfully.
Case 1. Done. Successfully.
load multipliers(1) = 72.60558199
load multipliers(2) = 162.44138222
load multipliers(3) = 292.81033942
```

Compare the obtained results with those in the table:

Nº	Theor. value	FIDESYS	
1	72.260	72.606	0.47%
2	164.835	162.441	1.47%
3	293.040	292.810	0.07%

2. Open the file with the results. There are three ways to do it:

- Click Ctrl+E.
- Select **Calculation** → **Open Results** in the Main Menu. Click **Open last result**.
- Select **Results** on Command Panel (Mode — **Results**). Click **Open Results**.

3. In a pop-up **Fidesys Viewer** window select a filter **Warp By Vector**.



4. In a pop-up filter **Warp By Vector** in the tab **Properties**, set the following parameters:

- Vectors: Mode 1 displacement;
- Scale Factor: 0.1.

5. Display Mode 1 displacement.

In **Fidesys Viewer** window set the following parameters on Toolbar:



Make sure that the first required critical value is displayed in the window **Critical value**.

6. View results.

As a result, the deformed body is displayed at the picture. To see the original model, click  near the model in the Model Tree. The picture below shows the deformed (solid grey filling) and the original model (with the distribution field Displacements for Mode 1).

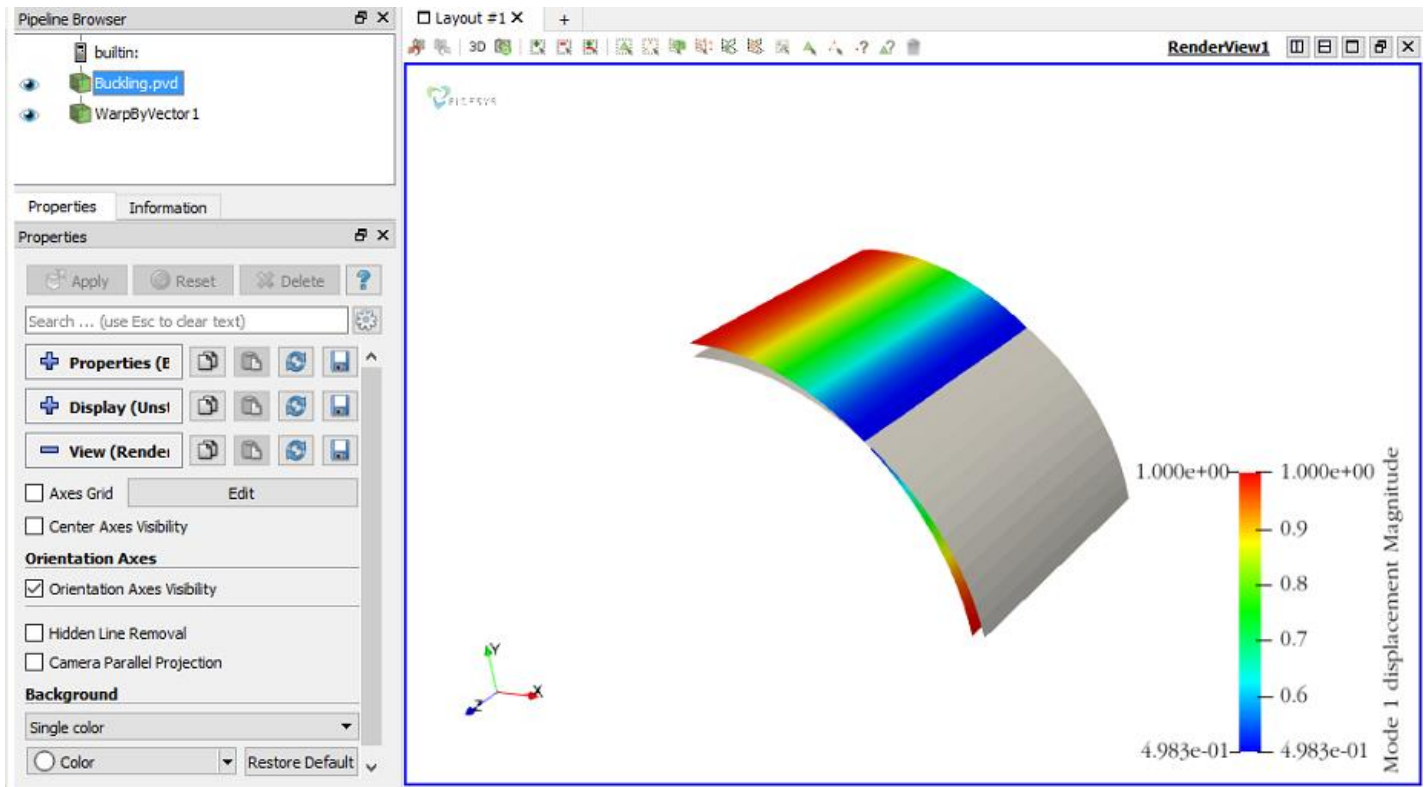

7. Select the filter **Warp By Vector** to do this. Set the following field value in the tab **Properties**:

- Vectors: Mode 2 displacement;
- Scale Factor: 0.1.

8. Display Mode 2 displacement.

In Fidesys Viewer window set the following parameters on Toolbar:

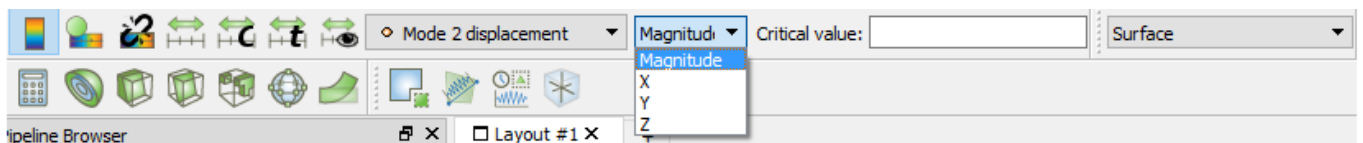

Make sure that the second required critical value is displayed in the window **Critical value**.

9. View results.

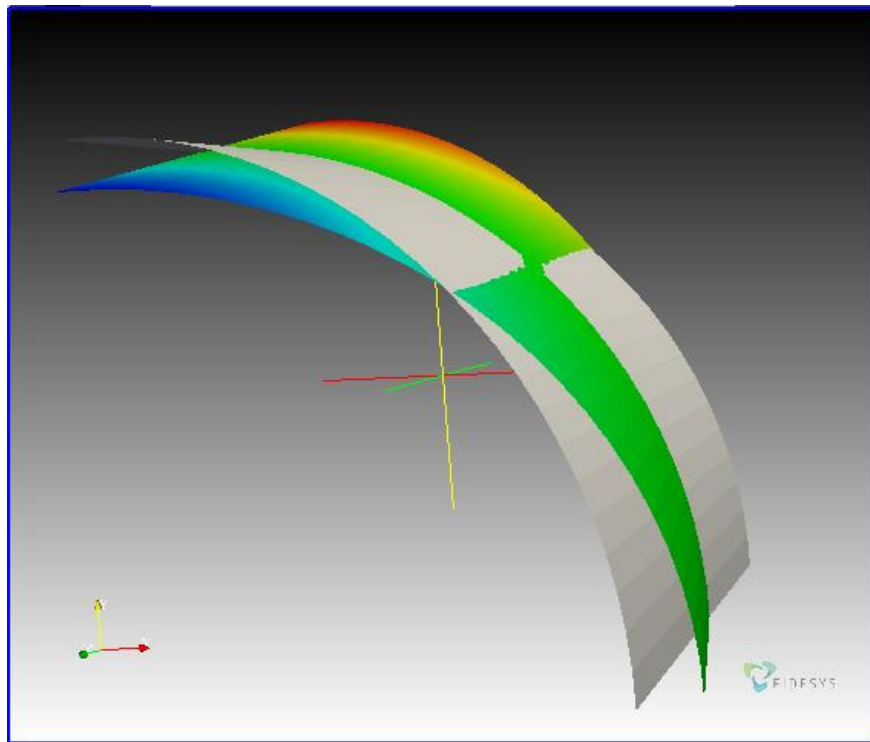

10. Similarly display Displacements for mode 3, make sure that the third required critical value is displayed in the window **Critical value**.

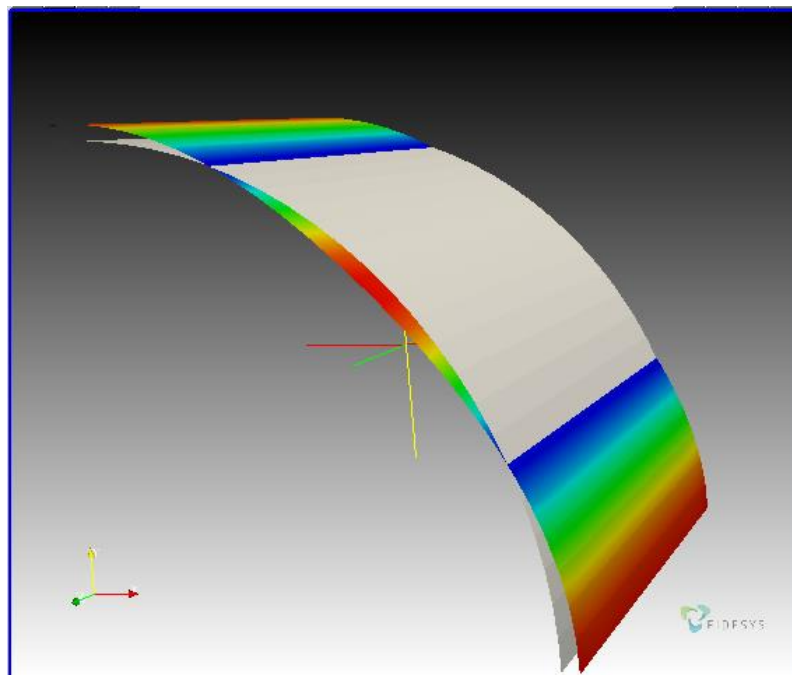

11. Display the 3D-view of the model (shell with thickness).

To do this, click on the name of the source file in the Model Tree. After this click 3D-view button in the default string.

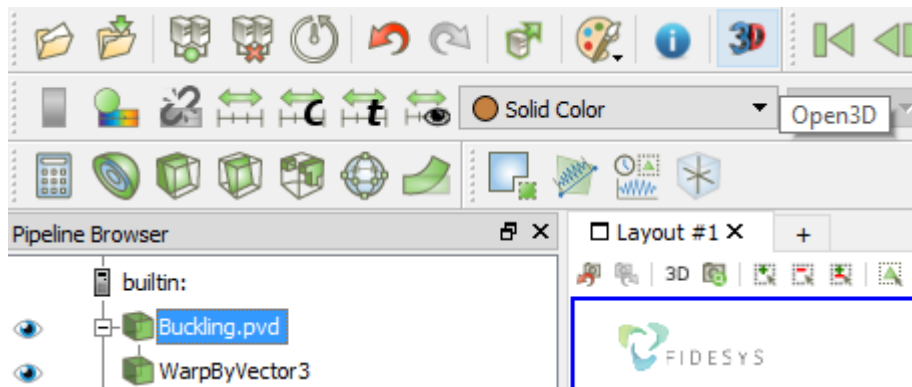

The file* _3D.pvd with a 3D-image of the shell must be opened and you will be able to apply various filters to it and to view its deformed view.

Choose the new file example_3D.pvd in the Model Tree and display Filters **Warp by Vector** for it with the following fields values:

- Vectors: Mode 1 displacement;
- Scale Factor: 0.1.

On the Toolbar, set once again the following parameters for the deformed type:



The first buckling mode will be displayed on the screen but the shell will be enveloped with thickness.

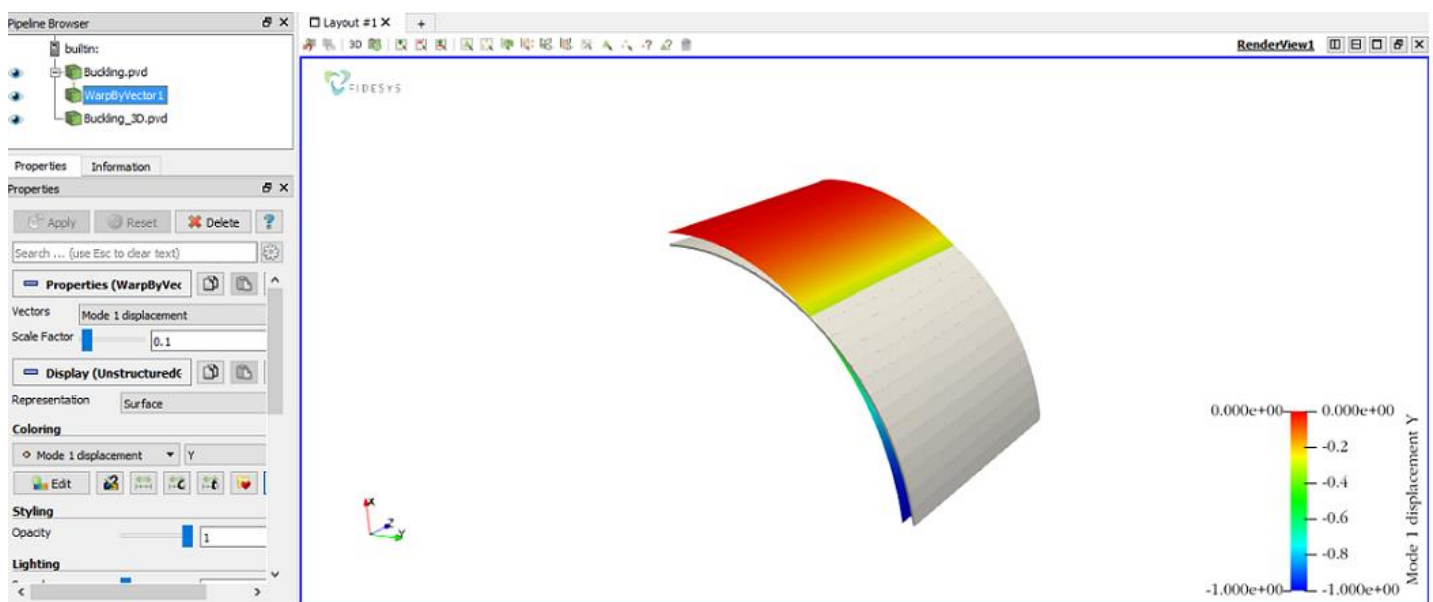

To apply all of the filters' changes automatically, click **Apply changes to parameters automatically** on Command Panel.

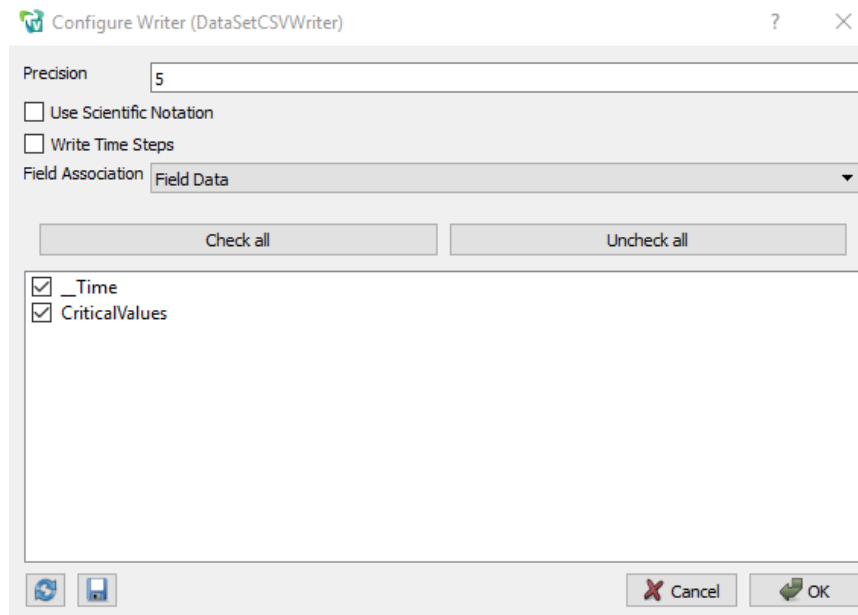

12. Download numerical data.

Select **File** → **Save Data** in the Main Menu or click Ctrl+S. Enter the file name (*.csv format), leave it by default. Click **OK**. In the pop-up window select:

- Field Association: Field Data.

The saved file is an ordinary table of numerical data which can be opened in any text editor.

Using Console Interface

For geometry generation, meshing, setting boundary conditions and materials you can use Console Interface.



It is also possible to run the file *stability_shell.jou* by selecting Journal Editor on Toolbar. In a pop-up window of the main menu select **File** → **Open** and open the necessary journal file.

Modal analysis (3D)

NAFEMS Selected Benchmarks for Natural Frequency Analysis "Simply Supported "Solid" Square Plate", Test No FV52.

We solve the problem of modal analysis of a square plate.

The picture represents a geometric model of the problem and a mesh:

The size of the plate is 10 m x 10 m x 1 m. Displacements along z-axis are constrained for the edges of the plate bottom side. The material parameters are $E = 200 \text{ hPa}$, $\nu = 0.3$, $\rho = 8000 \text{ kg/m}^3$.

Eigenmodes from 4 to 10 are to be compared.

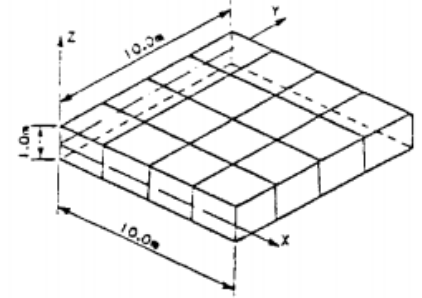

Geometry creation

1. Create the plate.

Select volume geometry generation section on Command Panel (Mode - **Geometry**, Entity - **Volume**, Action - **Create**).

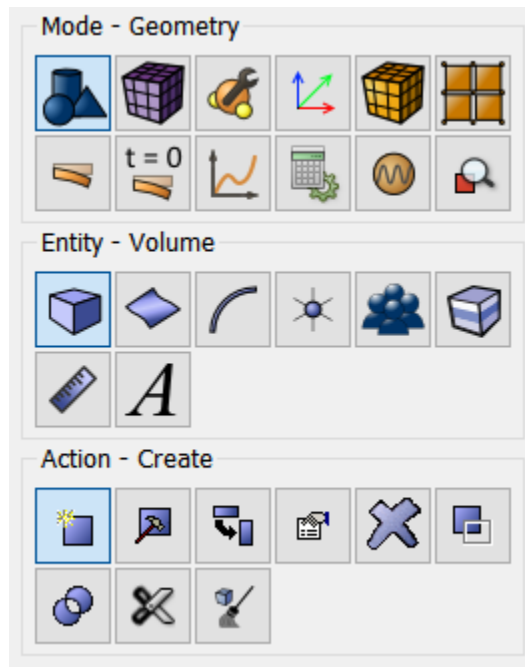

Select **Brick** in the list of geometric elements. Set the brick dimensions:

- X (width): 10;
- Y (height): 10;
- Z (depth): 1.

Click **Apply**.

Meshing

A mesh of 8*8*3 linear hexahedral elements is to be generated (as shown at the picture with the problem setting).

1. Select meshing on curves section on Command Panel (Mode - **Mesh**, Entity - **Curve**, Action - **Mesh**).

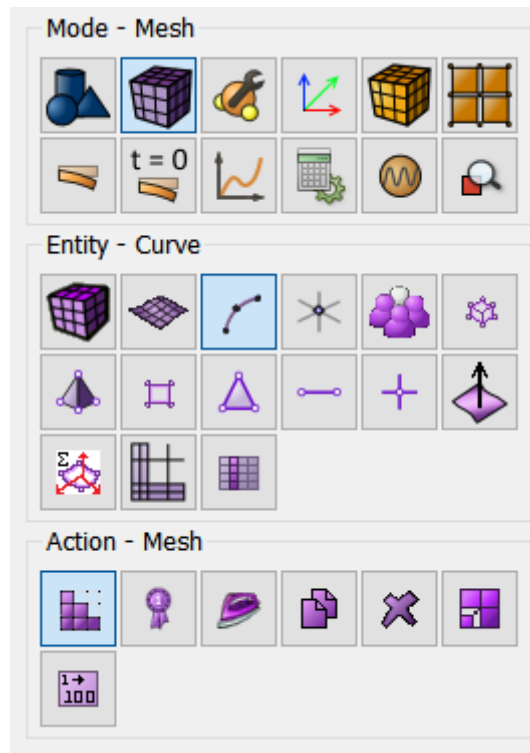

Specify the parameters of mesh refinement:

- Select Curves: 1 2 3 4 5 6 7 8 (*using space after each of them*);
- Select the way of meshing: Equal;
- Select splitting settings: Interval;
- Interval: 4 (*see the figure*).

Click **Apply Size**.

2. Select meshing on curves section on Command Panel (Mode - **Mesh**, Entity - **Curve**, Action - **Mesh**). Specify the parameters of mesh refinement:

- Select Curves: 9 10 11 12 (*using space after each of them*);
- Select the way of meshing: Equal;
- Select splitting settings: Interval;
- Interval: 1.

Click **Apply Size**.

Select volume mesh generation section on Command Panel (Mode - **Mesh**, Entity - **Volume**, Action - **Mesh**).

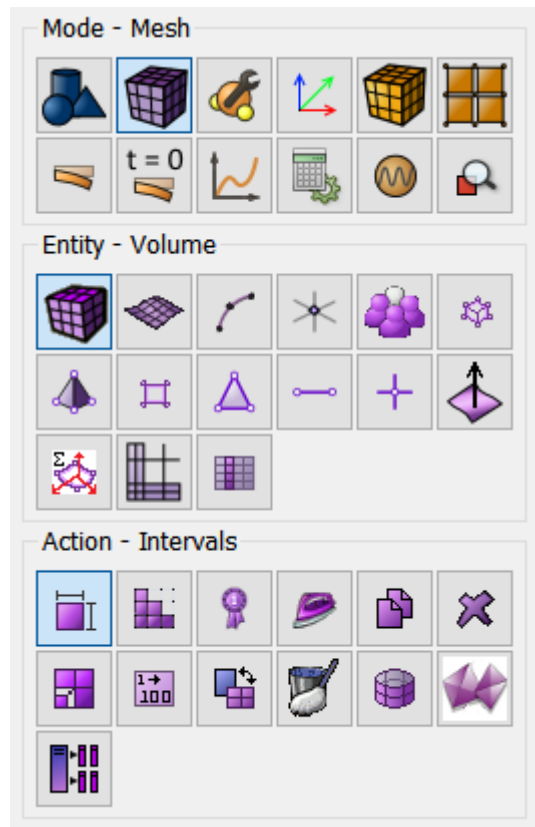

Specify the parameters of mesh refinement:

- Select Meshing Scheme: Automatic Sizing;
- Select Volumes: 1 (*or by the command **all***).

Click **Apply Size**.

Click **Mesh**.

Setting boundary conditions

1. Fix the bottom side edges along Z.

Select on Command Panel (Mode - **Boundary Conditions**, Entity - **Displacement**, Action - **Create**).

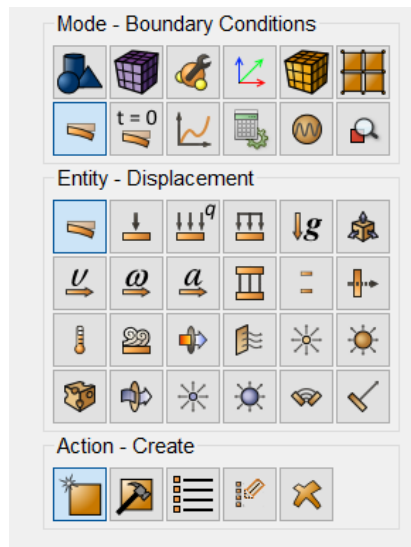

Set the following parameters:

- System Assigned ID;
- Entity List: Curve;
- Entity ID(s): 5 6 7 8 (*using space after each of them*);
- Degrees of Freedom: Z - Translation Disp;
- DOF Value: 0.

Click **Apply**.

Setting material and block properties

1. Create the material.

Select setting the material properties section on Command Panel (Mode - **Material**, Entity - **Materials Management**).

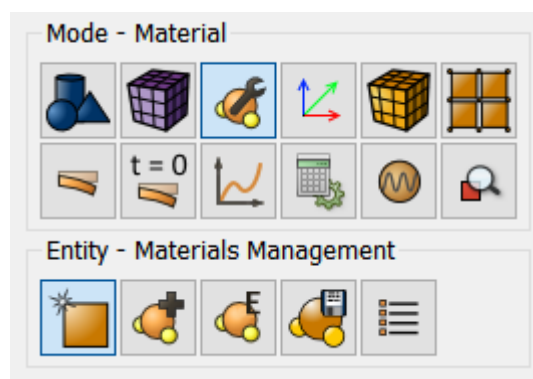

In the Materials Management window that opens, in the second column, click on the caption Enter the name of the material and write "Material 1". Press the ENTER key.

In the left column, select Elasticity - Hooke Material. Select with the mouse the characteristic Young's modulus. Hold down the left mouse button and drag the label to Material Properties. Double-click in the Value field next to Young's modulus and enter the number 2e11. Similarly, from the Hooke Material section add the Poisson Ratio 0.3. Density: 8000.

Click **Apply**.

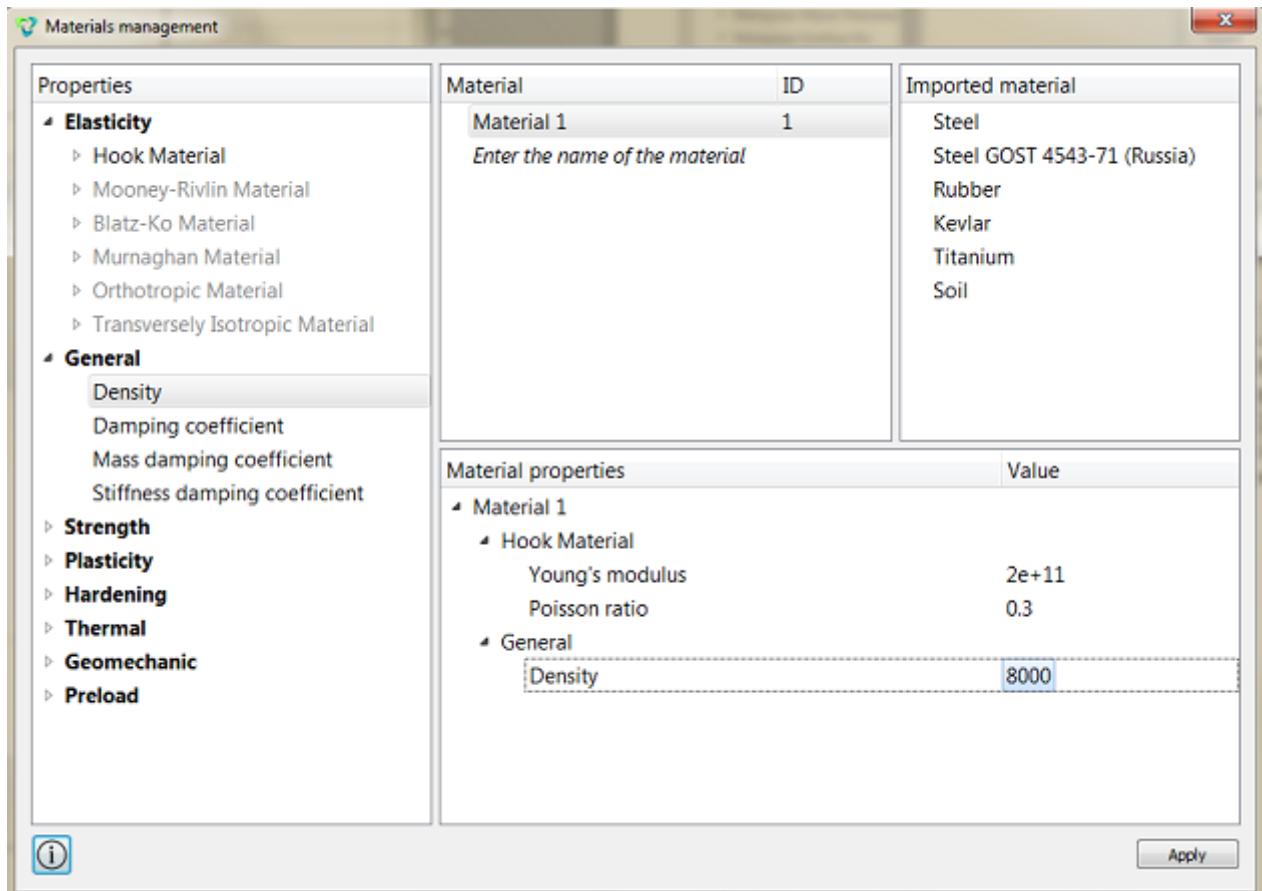

2. Create a block of one type of the material.

Select setting the material properties section on Command Panel (Mode - **Blocks**, Entity - **Block**, Action - **Add**).

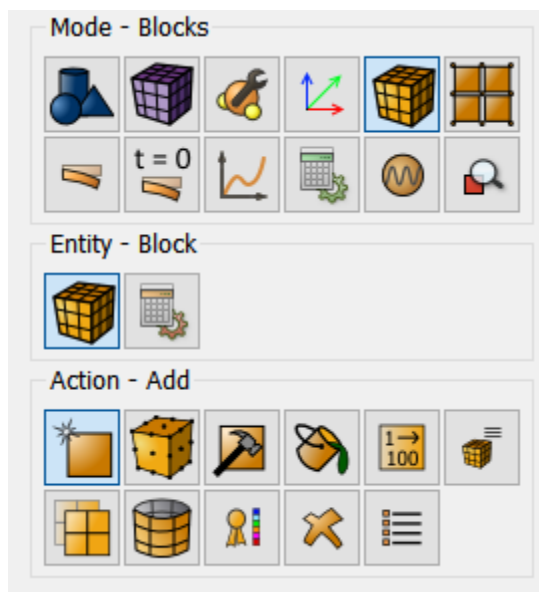

Set the following parameters:

- Block ID: 1;

- Entity list: Volume;
- ID: 1 (or by the command *all*).

Click **Apply**.

3. Set the block parameters.

On the command panel, select the mode for setting material properties (Mode - **Blocks**, Entity - **Block**, Action - **Block properties/parameters**).

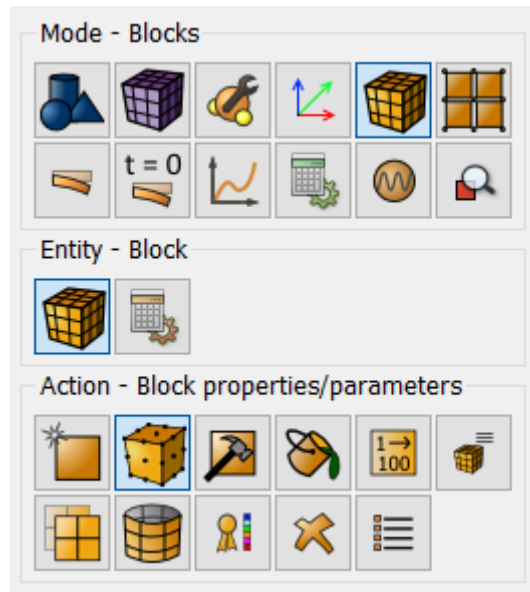

Set the following parameters:

- Block ID(s): 1;
- Material: Material 1;
- Coordinate System: Global Cartesian;
- Category: Solid;
- Order: 1.

Click **Apply**.

Starting calculation

1. Set the type of the problem to be solved.

Select calculation setting section on Command Panel (Mode - **Calculation Settings**, Calculation settings - **Mode frequency analysis**, ModeFrequency - **General**).

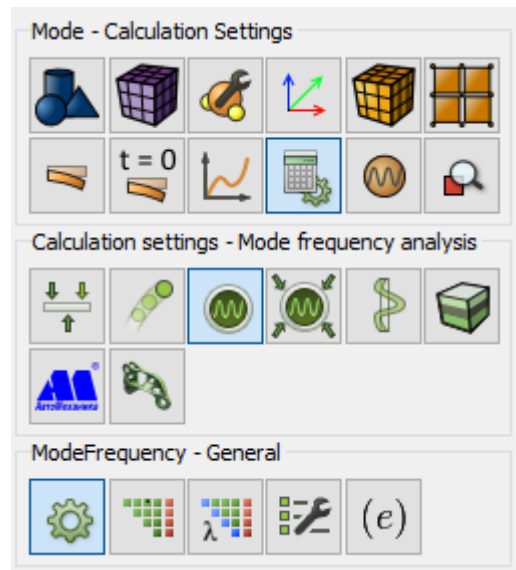

Specify the following settings:

- Interval: 20 - 250.

Click **Apply**.

Click **Start Calculation**.

2. In a pop-up window select a folder to save the result and enter the file name.

3. If the calculation is finished successfully, you will see a message in the Console: "*Calculation finished successfully at <date> <time>;*" as well as the required eigen values and frequencies.

Results analysis

1. Compare the obtained results with those in the given table.

№	NAFEMS	FIDESYS	
	Value, Hz	Value, Hz	Error
4	44.762	44.796	0.1%
5	110.52	110.54	0.0%
6	110.52	110.54	0.0%
7	169.08	169.09	0.0%
8	193.93	193.92	0.0%
9	206.64	206.63	0.0%
10	206.64	206.63	0.0%

2. Open the file with the result There are three ways to do it:

- Click Ctrl+E.

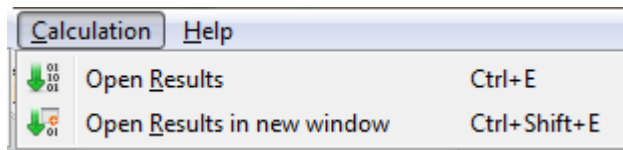

- Select **Calculation Open Results** in the Main Menu. Click **Open last result**.
- Select **Results** on Command Panel (Mode **Results**). Click **Open Results**.



3. You can see the way the body is deformed.

Select a filter **Warp By Vector** to do this. Set the following parameters in the tab **Properties**:

- Vectors: Eigenvalue_# (# stands for the number of the eigenvalue)
- Scale Factor: 700

As a result, the deformed body is displayed at the picture. To see the original model, click  near it in the Model Tree. The picture below shows the deformed model at different eigenvalues.

4 eigenmode

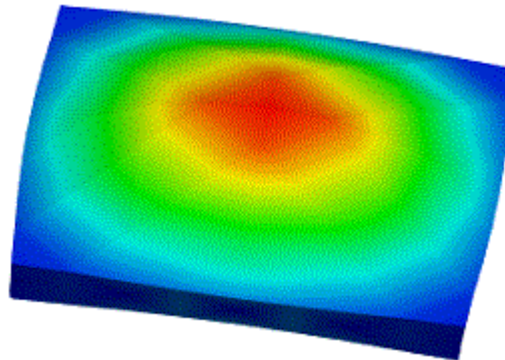

5 eigenmode

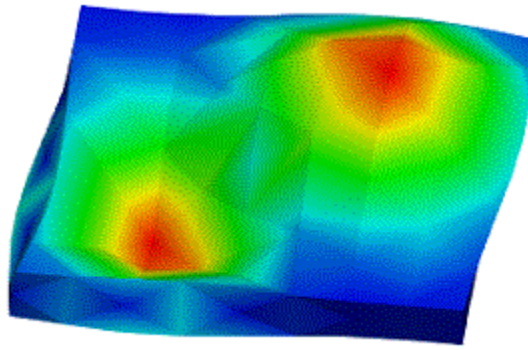

6 eigenmode

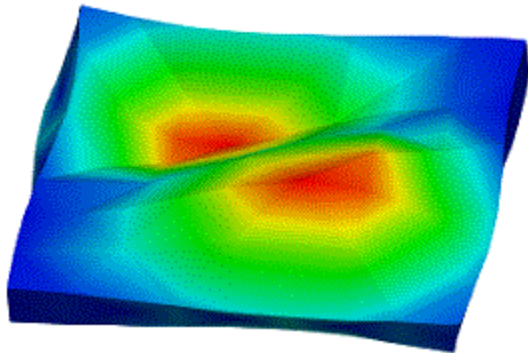

7 eigenmode

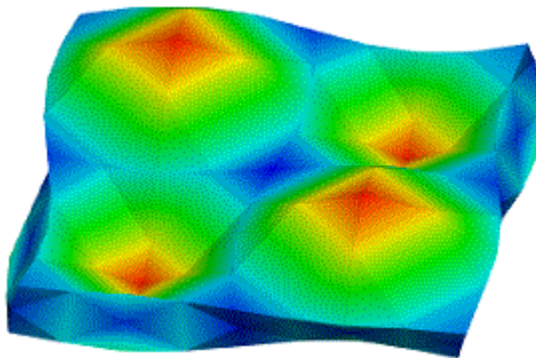

8 eigenmode

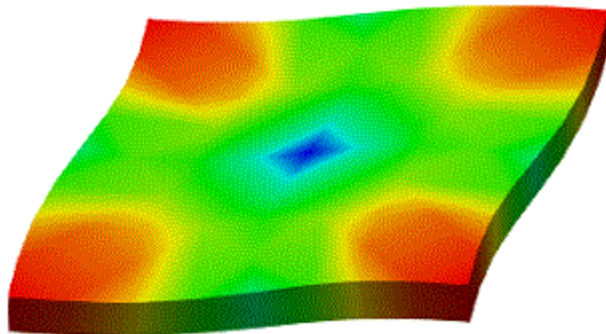

9 eigenmode

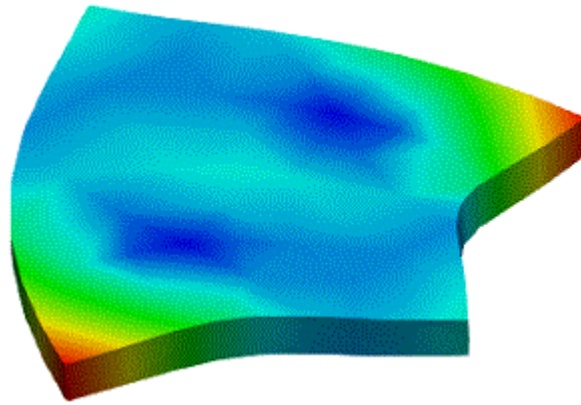

10 eigenmode

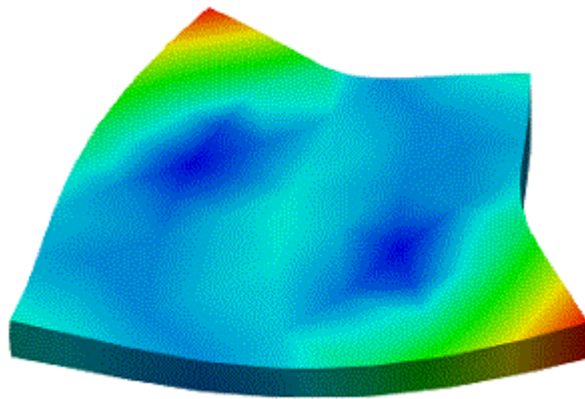

Using Console Interface

For geometry generation, meshing, setting boundary conditions and materials you can use Console Interface.



It is also possible to run the file *analysis_frequency_solid_model.jou* by selecting Journal Editor on Toolbar. In a pop-up window of the main menu select **File** → **Open** and open the necessary journal file.

Modal analysis (shell model)

NAFEMS-Glasgow, BENCHMARK newsletter, Report No. E1261/R002, "Free Vibrations of a Simply-supported Thin Square Plate", February 1989, p.21.

We solve the problem of modal analysis of a square plate.

The size of the plate is 10 m x 10 m, the thickness is 0.05 m. X- and Y-Translation and Z-Rotation are constrained for all nodes of the plate. All the edges are constrained in Z-direction. The X-rotation is constrained for edges AB and CD. The Y-rotation is constrained for edges BC and AD. The material parameters are $E = 200 \text{ hPa}$, $\nu = 0.3$, $\rho = 8000 \text{ kg/m}^3$.

We need to compare Eigenmodes from 1 to 8.

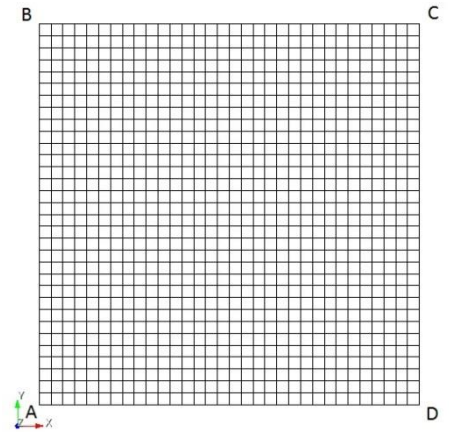

Geometry creation

1. Create the plate.

Select volume geometry generation section on Command Panel (Mode — **Geometry**, Entity — **Surface**, Action — **Create**).

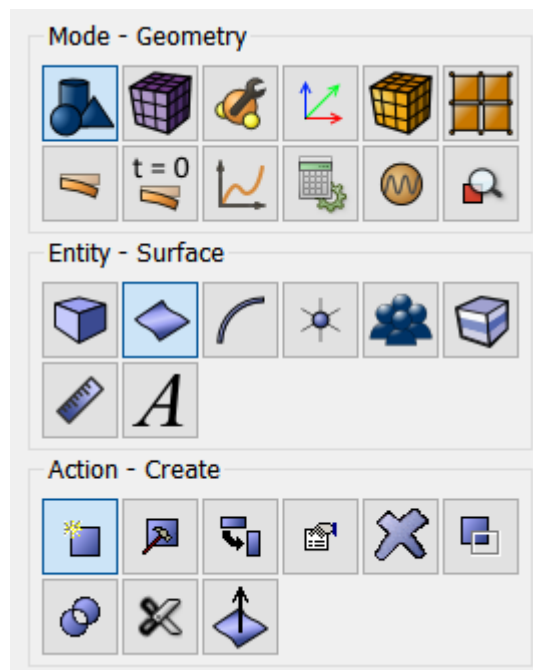

Select **Rectangle** in the list of geometric elements. Set the brick dimensions:

- Width: 10;
- Location: ZPlane.

Click **Apply**.

Meshing

A mesh of 32*32 linear quadrilateral elements is to be generated (as shown at the picture with the problem setting).

1. Select meshing on curves section on Command Panel (Mode — **Mesh**, Entity — **Curve**, Action — **Mesh**).

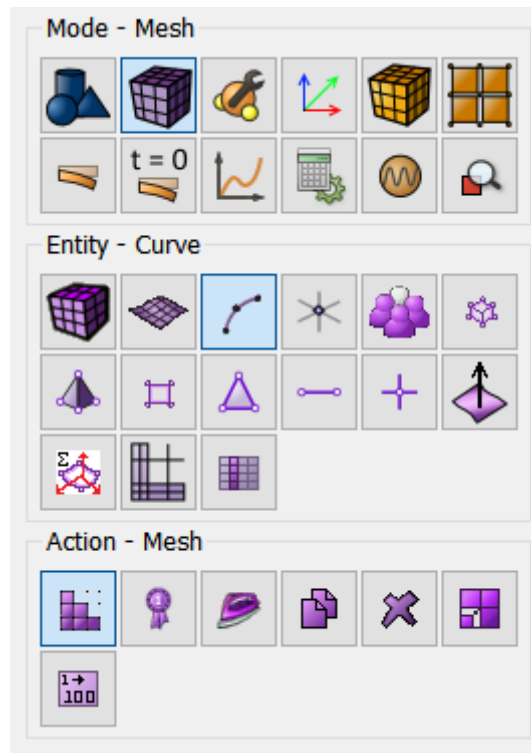

Specify the parameters of mesh refinement:

- Select Curves: all;
- Select the way of meshing: Equal;
- Select splitting settings: Interval;
- Interval: 32 (see the figure).

Click **Apply Size**.

Click **Mesh**.

2. Select surface mesh generation section on Command Panel (Mode — **Mesh**, Entity — **Surface**, Action — **Mesh**).

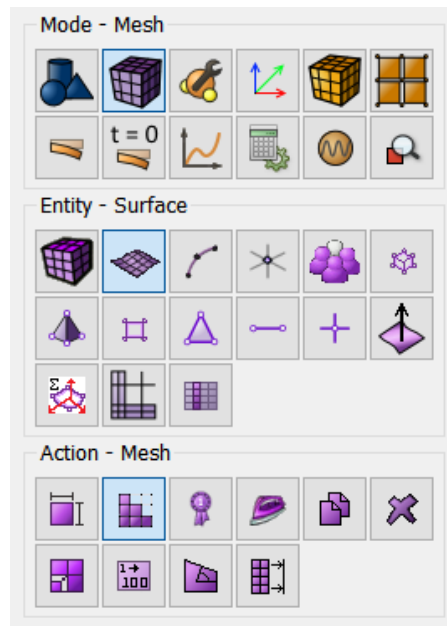

- Select Surfaces: 1 (or by the command **all**);
- Select Meshing Scheme: Automatically Calculate.

Click **Apply Scheme**.

Click **Mesh**.

Setting boundary conditions

1. Fix the plate: X- and Y-Translations and Z-Rotations.

Select on Command Panel (Mode — **Boundary Conditions**, Entity — **Displacement**, Action — **Create**).

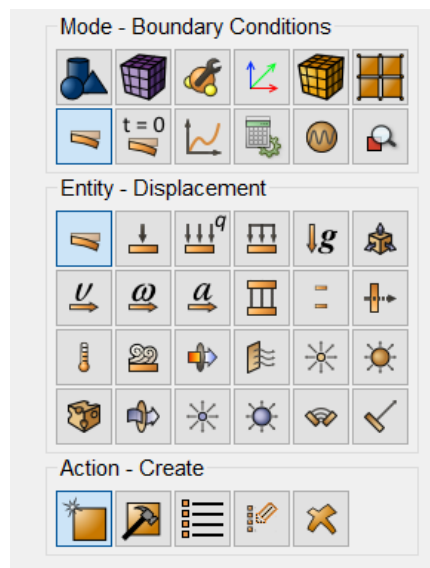

Set the following parameters:

- System Assigned ID;
- Entity List: Node;



- Entity ID(s): all;
- Degrees of Freedom: X-Translation, Y-Translation and Z-Rotation;
- DOF Value: 0.

Click **Apply**.

2. Fix all the edges at the Z-direction.

Select (Mode — **Boundary Conditions**, Entity — **Displacement**, Action — **Create**).

Set the following parameters:

- System Assigned ID;
- System Assigned ID;
- Entity ID(s): all;
- Degrees of Freedom: Z-Translation;
- DOF Value: 0.

Click **Apply**.

3. Fix the edges AB and CD on X-Rotation.

Select (Mode — **Boundary Conditions**, Entity — **Displacement**, Action — **Create**).

Set the following parameters:

- System Assigned ID;
- Entity List: Curves;
- Entity ID(s): 2 4 (using space after each of them);
- Degrees of Freedom: X-Rotation;
- DOF Value: 0.

Click **Apply**.

4. Fix the edges BC and AD in Y-rotation.

Select on Command Panel (Mode — **Boundary Conditions**, Entity — **Displacement**, Action — **Create**).

Set the following parameters:

- System Assigned ID;
- Entity List: Curves;
- Entity ID(s): 1 3 (using space after each of them);
- Degrees of Freedom: Y-Rotation;
- DOF Value: 0.

Click **Apply**.

Setting material and block properties

1. Create the material.

Select setting the material properties section on Command Panel (Mode — **Material**, Entity — **Materials Management**).

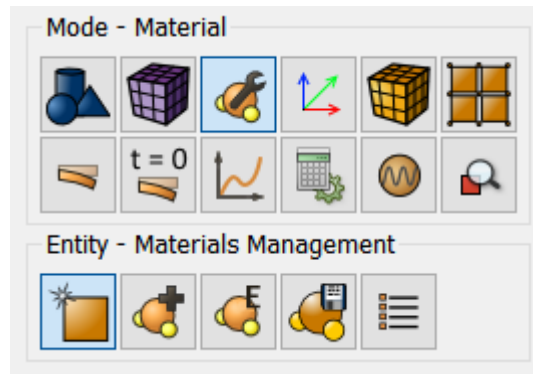

In the Materials Management window that opens, in the second column, click on the caption Enter the name of the material and write “Material 1”. Press the ENTER key.

In the left column, select Elasticity - Hooke Material. Select with the mouse the characteristic Young's modulus. Hold down the left mouse button and drag the label to Material Properties. Double-click in the Value field next to Young's modulus and enter the number 200e9. Similarly from the Hooke Material section add the Poisson Ratio 0.3, Density: 8000.

Click **Apply**.

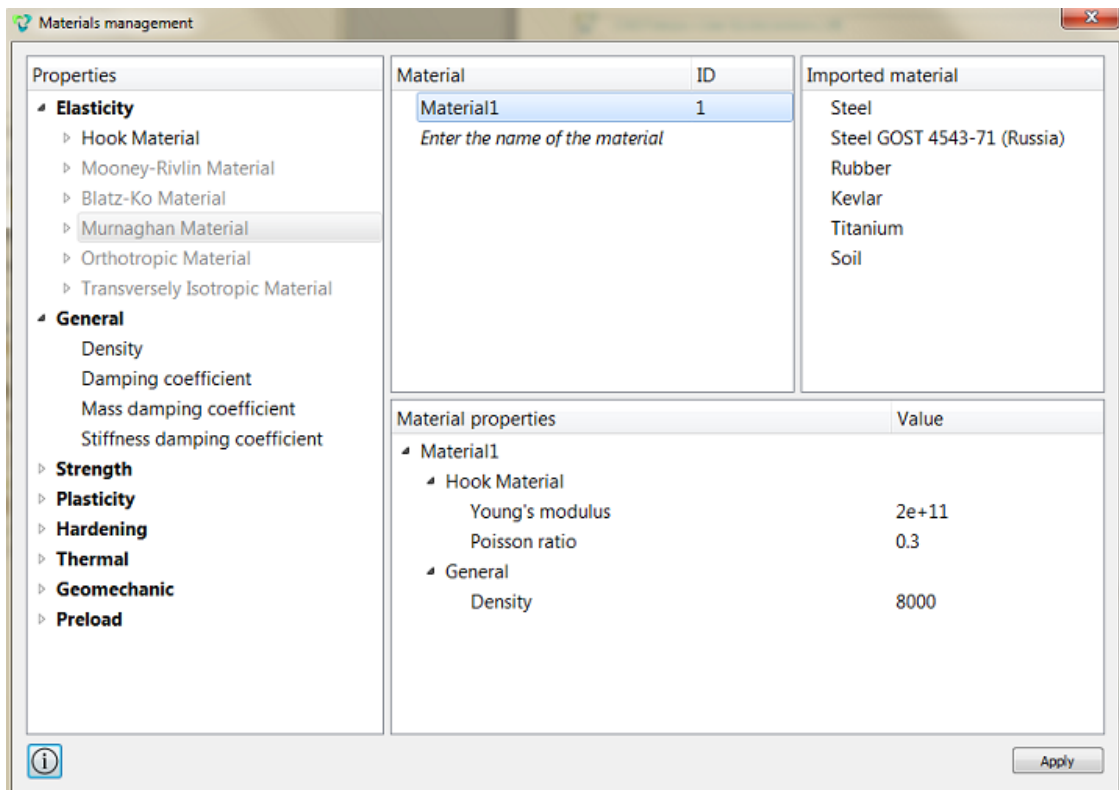

2. Create the block of one type of the material

Select setting the material properties section on Command Panel (Mode — **Blocks**, Entity — **Block**, Action — **Add**).

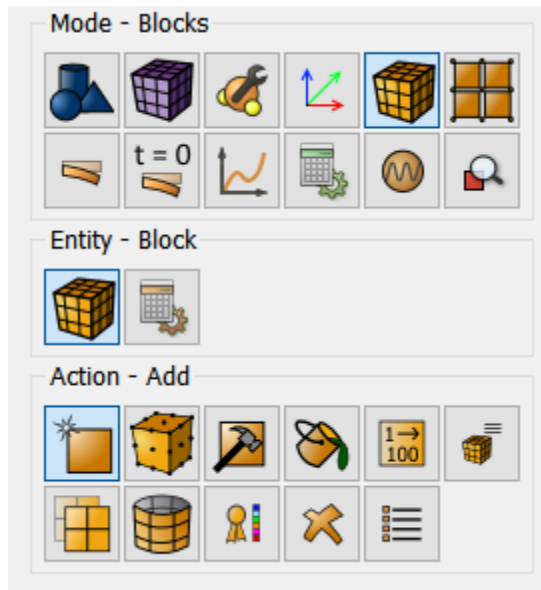

Set the following parameters:

- Block ID: 1;
- Entity list: Surface;
- ID: 1 (or by the command **all**).

Click **Apply**.

3. Set the block parameters.

On the command panel, select the mode for setting material properties (Mode - **Blocks**, Entity - **Block**, Action - **Block properties/parameters**).

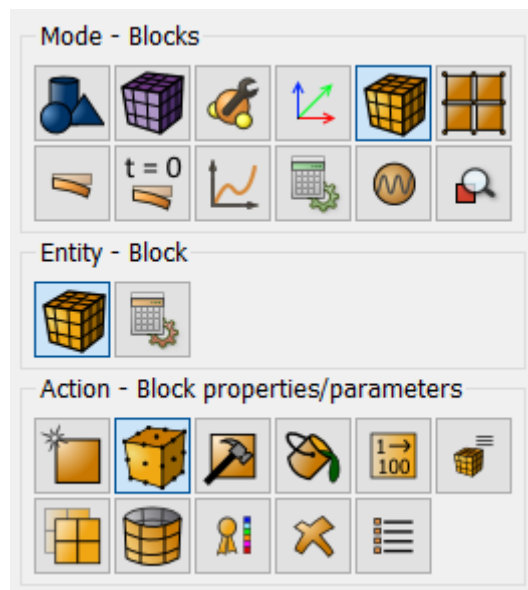

Set the following parameters:

- Block ID(s): 1;
- Available materials: Material 1;
- Coordinate System: Global Cartesian;
- Category: Shell;
- Order: 1.

Click **Set Shell Properties**. Set the following parameters:

- Thickness: 0.05;
- Eccentricity: 0.5.

Click **Apply**.

Close the window **Set Shell Properties**.

Click **Apply**.

Starting calculation

1. Set the type of the problem to be solved.

Select calculation setting section on Command Panel (Mode — **Calculation Settings**, Calculation settings — **Mode frequency analysis**, ModeFrequency — **General**).

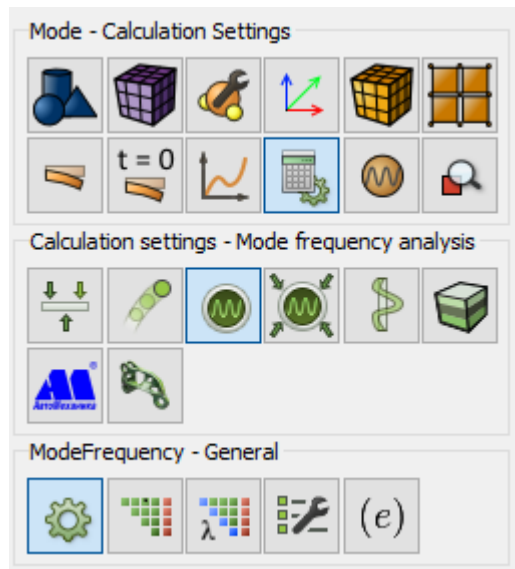

Set the default settings.

Click **Apply**.

Click **Start Calculation**.

2. In a pop-up window select a folder to save the result and enter the file name.

3. If the calculation is finished successfully, you will see a message in the Console: “Calculation finished successfully at <date> <time>” as well as the required eigenvalues and frequencies.

Results analysis

1. Compare the obtained results to those given in the picture.

```
Command Line
Number      Eigenfrequency (Hz)
1           2.379046
2           5.963525
3           5.963525
4           9.544129
5           11.993268
6           11.993268
7           15.567361
8           15.567361
9           20.553239
10          20.553239
Case 1. Done. Successfully.
Calculation has finished successfully.
Peak memory (RAM) consumption is: 253.496094 MB
Calculation finished successfully at 2020-12-3 15:36:41

Fidesys>
```

Commands | Error | History

2. Open the file with the results. There are three ways to do it:

- Click Ctrl+E.
- Select **Calculation** → **Open Results** in the Main Menu. Click **Open last result**.



- Select **Results** on Command Panel (Mode — **Results**). Click **Open Results**.

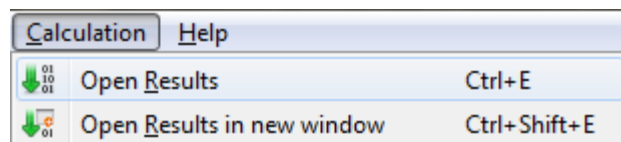

3. You can see the way the body is deformed under the applied pressure.

Select a filter **Warp By Vector** to do this. Set the following parameters in the tab **Properties**:

- Vectors: Eigenvalue_# (# stands for the number of the eigenvalue);
- Scale Factor: 200.

As a result, the deformed body is displayed at the picture. To see the original model, click near it in the Model Tree. The picture below shows the deformed model at different eigenvalues.

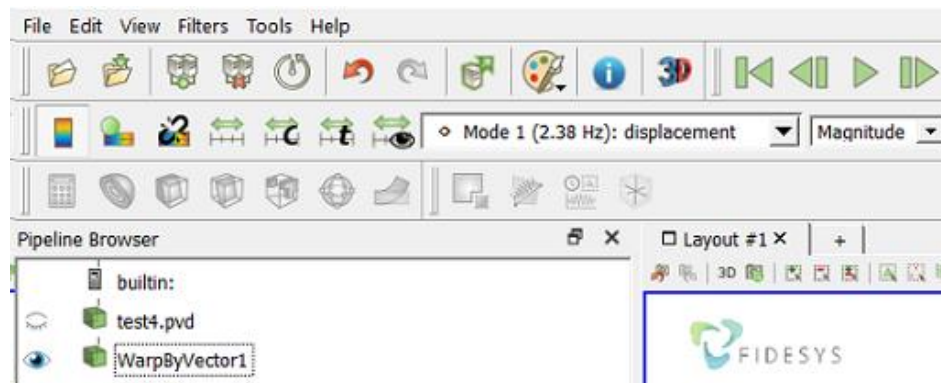

4. Display the 3D-view of the model (shell with thickness).

To do this, click on the name of the source file in the Model Tree. After this click 3D-view button in the default string.



The file *_3D.pvd with a 3D-image of the shell will open and you will be able to apply various filters to it and to view its deformed view.

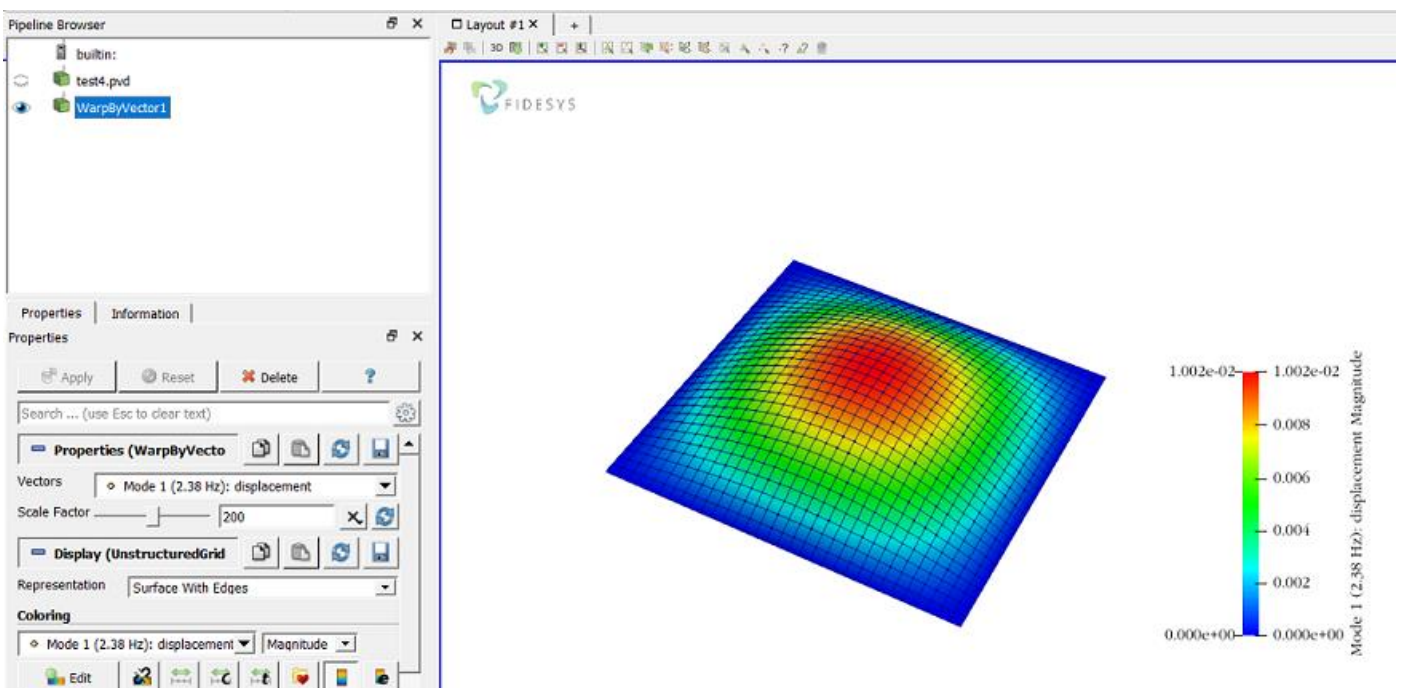

Using Console Interface

For geometry generation, meshing, setting boundary conditions and materials you can use Console Interface.



It is also possible to run the file *modal_shell.jou* by selecting Journal Editor on Toolbar. In a pop-up window of the main menu select **File** → **Open** and open the necessary journal file.

Setting heat transfer (3D, working with two blocks)

We solve the 3D problem of a hollow two-material cylinder the inner and outer surfaces of which undergo convection.

The pictures represent a geometric model of the problem:

The inner radius of the cylinder $R_i = 0.30$ m, the middle radius of the cylinder (at the place of material changing) $R_m = 0.35$ m, the external radius of the cylinder $R_e = 0.37$ m.

Convective heat exchange with internal temperature $T_i = 70$ °C and coefficient $h_i = 150$ W/ m²/°C occurs on the inner surface of the cylinder. Convective heat exchange with exterior temperature $T_e = -15$ °C and coefficient $h_e = 200$ W/ m²/°C occurs on the outer surface of the cylinder.

Materials are isotropic. The material heat transfer 1 is $V_1 = 40$ W/(m·°C). The material heat transfer 2 is $V_2 = 20$ W/(m·°C).

Test pass criterion is the following:

at the point (0.3, 0, 0) heat flux 6687 W/ m² is within 1%.

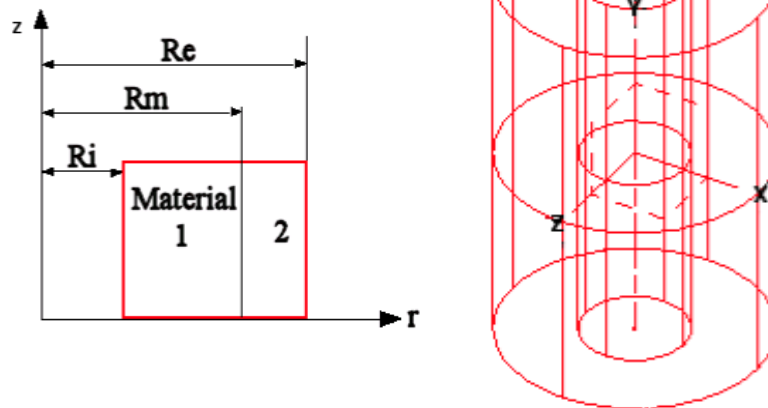

Geometry creation

1. Create the first cylinder.

Select volume geometry generation section on Command Panel (Mode – **Geometry**, Entity – **Volume**, Action – **Create**).

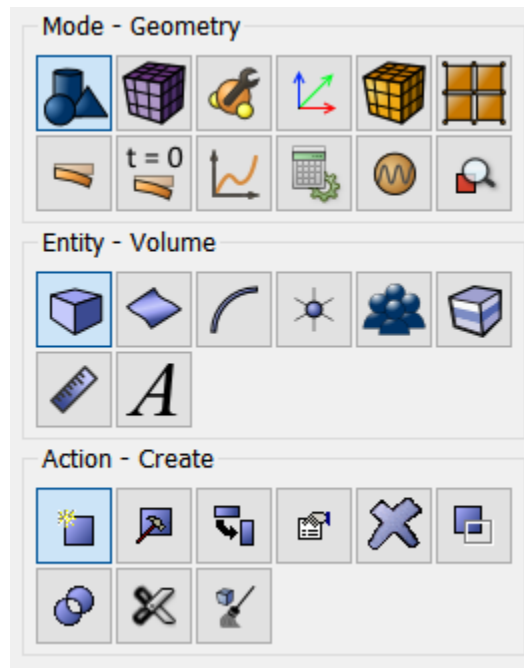

Select **Cylinder** in the list of geometric elements. Specify the cylinder dimensions:

- Height: 0.01;
- Circular;
- Radius: 0.3.

Click **Apply**.

2. Create the second cylinder.

Select volume geometry generation section on Command Panel (Mode — **Geometry**, Entity — **Volume**, Action — **Create**).

Select **Cylinder** in the list of geometric elements. Specify the cylinder dimensions:

- Height: 0.01;
- Circular;
- Radius: 0.35.

Click **Apply**.

3. Create the third cylinder.

Select volume geometry generation section on Command Panel (Mode — **Geometry**, Entity — **Volume**, Action — **Create**).

Select **Cylinder** in the list of geometric elements. Specify the cylinder dimensions:

- Height: 0.01;
- Circular;
- Radius: 0.37.

Click **Apply**.

As a result, three generated entities are displayed in the Model Tree (Volume 1, Volume 2 and Volume 3).

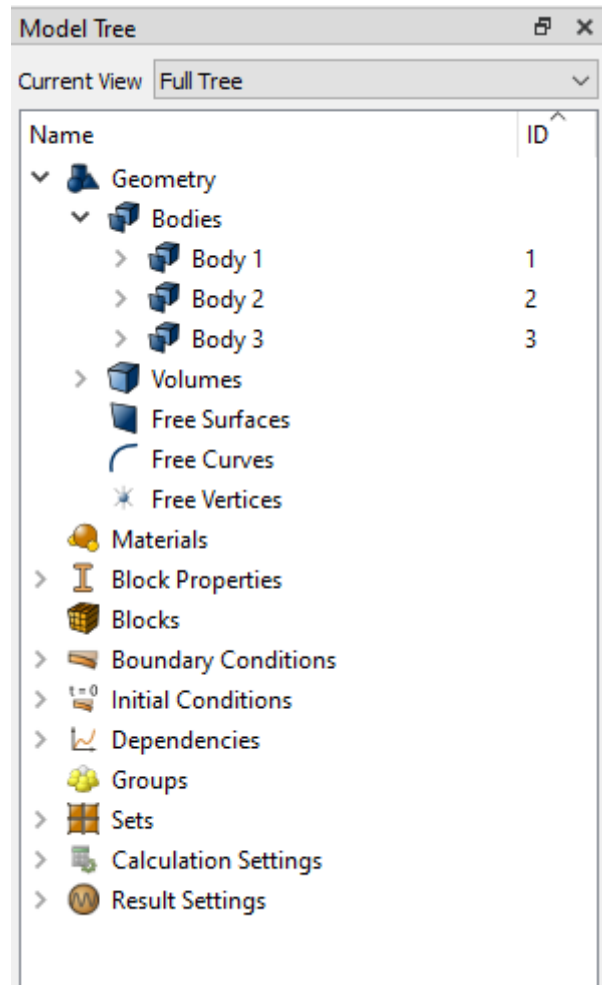

4. Subtract the first cylinder from the second one.

Select volume geometry generation section on Command Panel (Mode — **Geometry**, Entity — **Volume**, Action — **Boolean**).

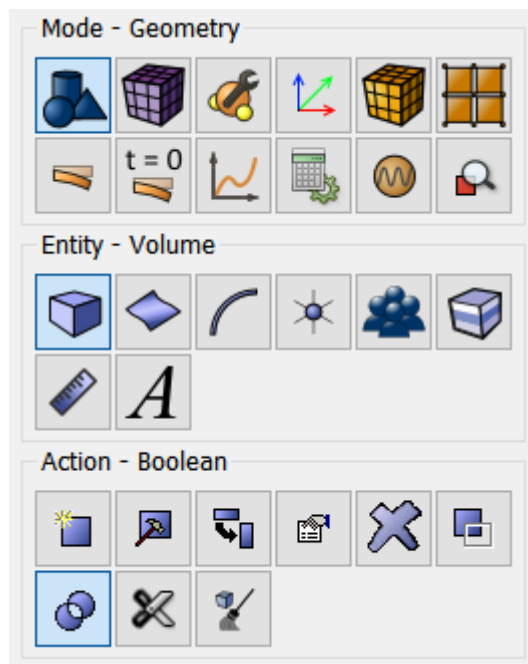

Meshing

1. Select meshing on curves section on Command Panel (Mode — **Mesh**, Entity — **Curve**, Action — **Mesh**).

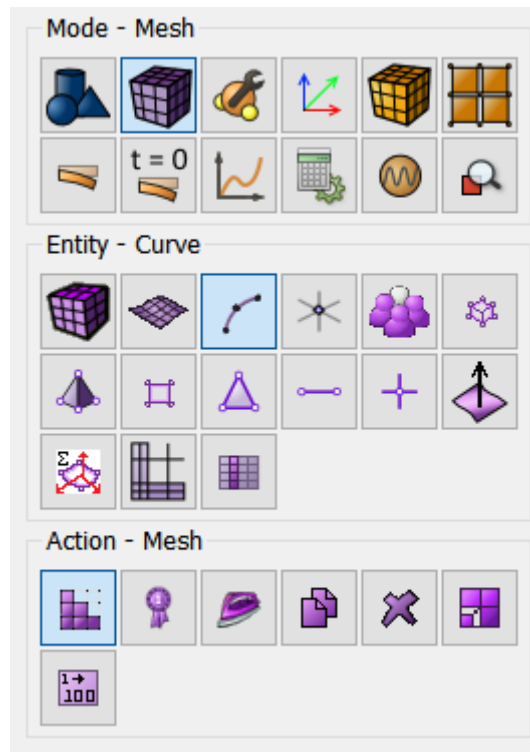

Specify the parameters of mesh refinement:

- Select Curves: all (*mesh will be create on all the curves*);
- Select the way of meshing: Equal;
- Select the meshing parameters: Interval;
- Interval: 200.

Click **Apply Size**.

2. Select volume mesh generation section on Command Panel (Mode — **Mesh**, Entity — **Volume**, Action — **Mesh**).

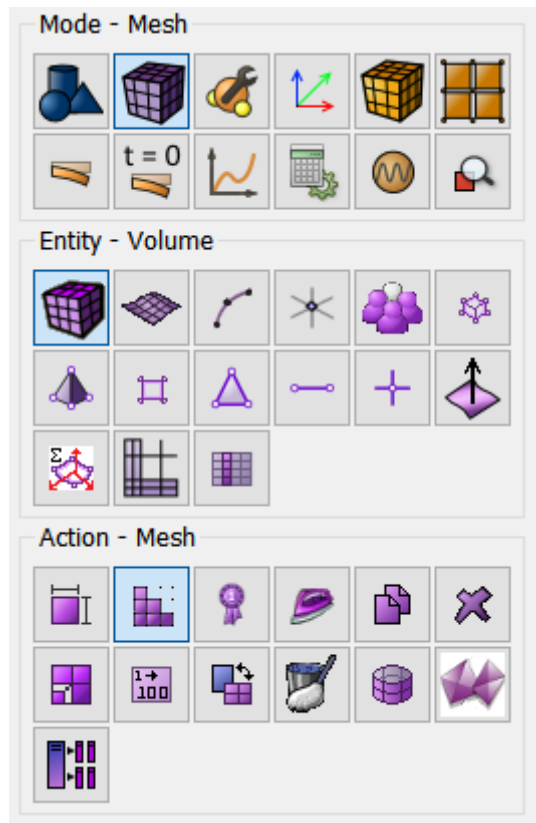

- Select meshing scheme: Polyhedron.
- Select Volumes: all (*mesh will be create on all the volumes*);

Click **Apply Scheme**.

Click **Mesh**.

Setting material and block properties

1. Create Material 1.

Select setting the material properties section on Command Panel (Mode — **Blocks**, Entity — **Materials Management**).

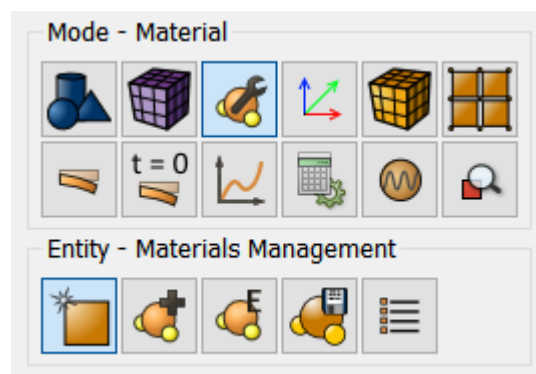

Specify the name of the material. Material 1. Drag from the left column to the section Thermal of the label Thermal isotropic in the Material Properties column.

Set the following parameters:

- Thermal Expansion coefficient: 40.

Click **Apply**.

2. Create Material 2.

Select setting the material properties section on Command Panel (Mode — **Blocks**, Entity — **Materials Management**).

Specify the name of the material. Material 2. Drag from the left column to the section Thermal of the label Thermal isotropic in the Material Properties column.

Set the following parameters:

- Thermal Expansion coefficient: 20.

Click **Apply**.

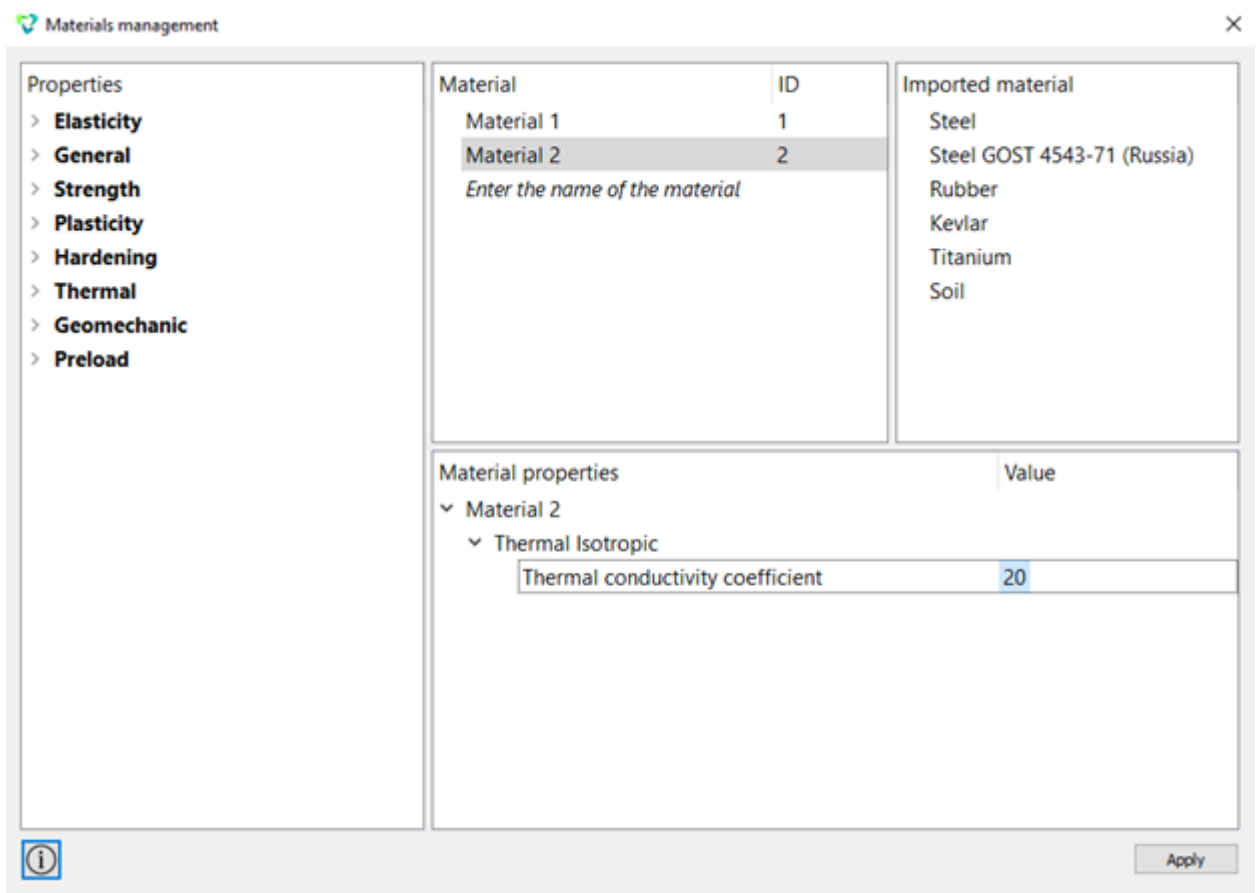

3. Create Block 1.

Select setting the material properties section on Command Panel (Mode — **Blocks**, Entity — **Block**, Action — **Add**).

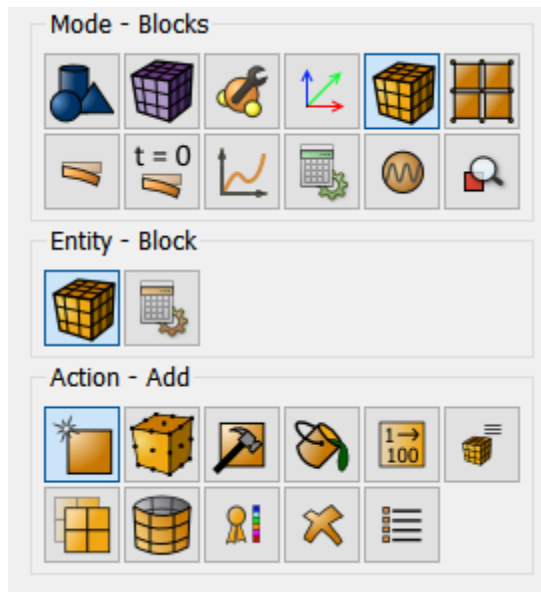

Set the following parameters:

- Block ID: 1;
- Entity List: Volume;
- Entity ID(s): 4.

Click **Apply**.

4. Create Block 2.

Select setting the material properties section on Command Panel (Mode — **Blocks**, Entity — **Block**, Action — **Add**).

Set the following parameters:

- Block ID: 2;
- Entity list: Volume;
- Entity ID(s): 5.

Click **Apply**.

5. Set parameters for block № 1.

On the command panel, select the mode for setting material properties (Mode - **Blocks**, Entity - **Block**, Action - **Block properties/parameters**).

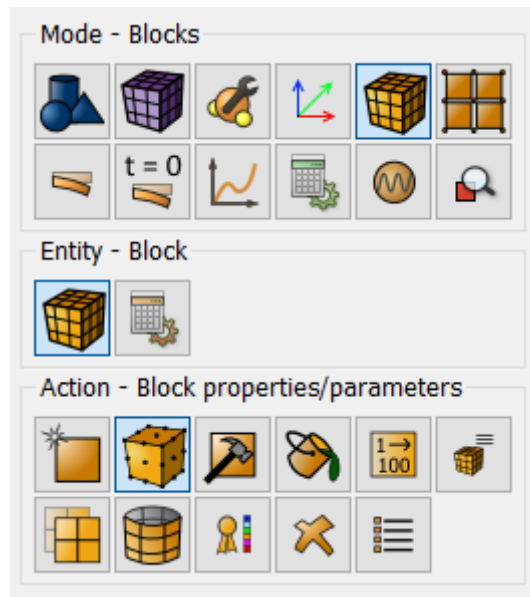

Set the following parameters:

- Block ID(s): 1;
- Category: Solid;
- Material: Material 1;
- Coordinate System: Global Cartesian;
- Order: 1.

Click **Apply**.

6. Set parameters for block № 2.

On the command panel, select the mode for setting material properties (Mode - **Blocks**, Entity - **Block**, Action - **Block properties/parameters**).

Set the following parameters:

- Block ID(s): 2;
- Category: Solid;
- Material: Material 2;
- Coordinate System: Global Cartesian;
- Order: 1.

Click **Apply**.

Setting boundary conditions

1. Set the process of convective heat exchange on the inner surface of the cylinder.

Select on Command Panel (Mode — **Boundary Conditions**, Entity — **Convection**, Action — **Create**).

Select on Command Panel (Mode — **Boundary Conditions**, Entity — **Displacement**, Action — **Create**).

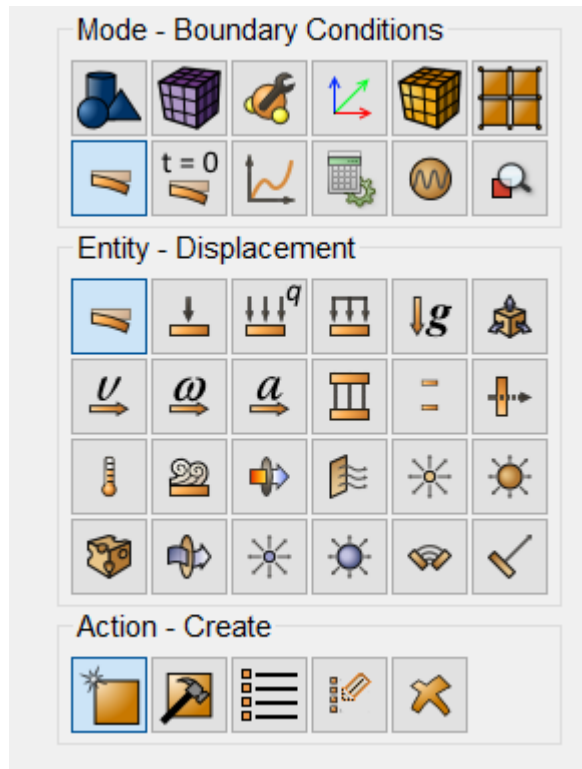

Set the following parameters:

- System Assigned ID;
- Entity List: Surface;
- Entity ID(s): 12 13 16 17 (*using space after each of them*);
- Degrees of Freedom: Z-Translation Disp;
- DOF Value: 0.

Click **Apply**.

Starting calculation

1. Set the type of the problem to be solved.

Select calculation setting section on Command Panel (Mode — **Calculation Settings**, Calculation settings — **Static**, Static — **General**).

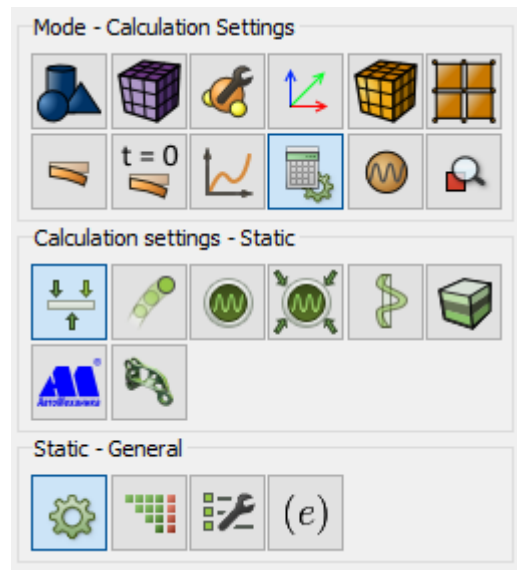

Set the solver settings:

- Dimensions: 3D;
- Model: Elasticity
- Model: Heat transfer..

Click **Apply**.

2. In a pop-up window select a folder to save the result and enter the file name.

3. If the calculation is finished successfully, you will see a message in the Console: “*Calculation finished successfully at <date> <time>*”.

Results analysis

1. Open the file with the results. You can do this in one of the three ways.

- Click Ctrl+E.
- Select **Calculation Open Results** in the Main Menu. Click **Open last result**.
- Select **Results** on Command Panel (Mode — **Results**). Click **Open Results**.

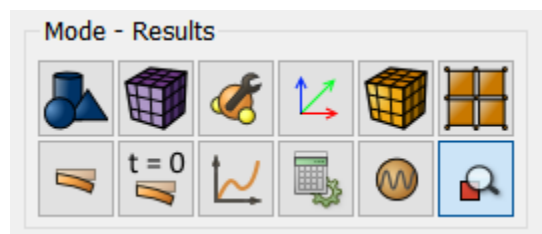

2. Display the component of the heat flux.

In *Fidesys Viewer* window set the following parameters on Toolbar:

- Representation Mode: Surface;
- Representation Field: HeatFlux.





To display the color legend scale, click the button **Switch the color legend visibility** on Command Panel.

3. Select a point where you need to view the heat flux.

In the Main Menu, select the filter **Probe Location**. In the tab **Properties** set the coordinates of the point A where you need to view the stress:

- Show Point;
- Point (coordinates): 0.3 0 0;
- Number of Points: 1;
- Radius: 0.

Click **Apply**.



To apply all of the filters changes automatically, click **Apply changes to parameters automatically** on Command Panel.

As a result, point A is displayed at the picture.

Showing	ProbeLocation1	Attribute:	Point Data	Precision:	6
Point ID	0				
Block ID	1				
Global Element ID	723				
Heat Flux	6686.47; 6686.47; -0.00143302; 3.34819e-11				
Material ID	1				
Node ID	3445				
Parent ID	4				
Points	0.3; 0; 0				
Temperature	25.4127				
vtkValidPointMask	1				

4. View a numerical value of the heat flux at the selected point A.

See the heat flux values in the line **HeatFlux** in the tab **Information** in the field **Data Arrays**.

Name	Data Type	Data Ranges
Block ID	[1, 1]	
Global Element ID	[723, 723]	
Heat Flux	[6686.47, 6686.47], [-0.00143302, -0.00143302], [3.34819e-11, 3.34819e-11]	
Material ID	[1, 1]	
Node ID	[3445, 3445]	
Parent ID	[4, 4]	
Temperature	[25.4127, 25.4127]	
vtkValidPointMask	[1, 1]	

The heat flux value is calculated using the following formula:

$$\sqrt{\varphi_x^2 + \varphi_y^2 + \varphi_z^2} = \sqrt{6686.41^2 + (-0.00302395)^2 + (8.02105e - 05)^2} = 6686.41$$

The difference between the obtained value 6686.41 and the required one 6 687 is 0.01%.

5. Download numerical data.

Select **File Save Data** in the Main Menu or click **Ctrl+S**. Enter the file name (*.csv format), leave it by default. Click **OK**. The saved file is an ordinary table of numerical data which can be opened in any text editor.

Using Console Interface

For geometry generation, meshing, setting boundary conditions and materials you can use Console Interface.



It is also possible to run the file *thermal_conductivity.jou* by selecting Journal Editor on Toolbar. In a pop-up window of the main menu select **File** → **Open** and open the necessary journal file.

Dynamic load: nonsteady heat transfer (3D, implicit scheme)

The 3D problem of 1D nonsteady heat transfer inside a beam is being solved.

The picture below represents a geometric model of the problem:

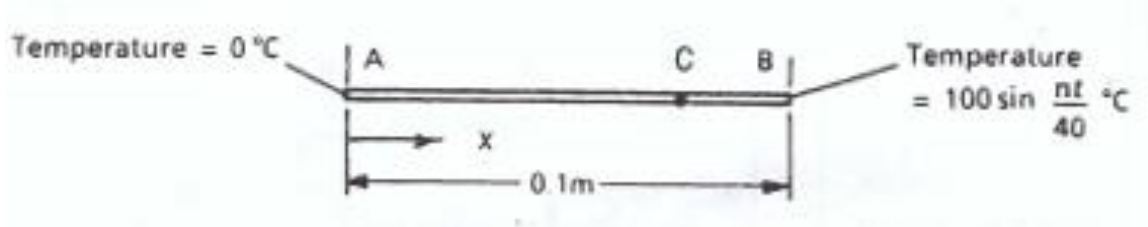

The beam length is 0.1 m, square cross section is 0.01x0.01 m. The temperature at the point A is $T_A = 0$ °C, the temperature at the point B varies harmonically: $T_B = 100 \sin \frac{\pi t}{40}$ °C. The material parameters are isotropic, $V = 35$ W/(m·°C), $C = 440.5$ J/(kg·°C), $\rho = 7\,200$ kg/m³.

Test pass criterion is the following: temperature T at the point C (0.8;0;0) at time $t = 32c$ is 36.60°C within 2%.

Geometry creation

1. Create the sliver parallelepiped.

Select volume geometry generation section on Command Panel (Mode - **Geometry**, Entity - **Volume**, Action - **Create**).



Select **Brick** in the list of geometric elements. Set the brick dimensions:

- X (width): 0.1;
- Y (height): 0.01;

- Z (depth): 0.01.

Click **Apply**.

2. Combine left edge of the beam with the origin of coordinates.

Set the following parameters: Select volume geometry modification section on Command Panel (Mode - **Geometry**, Entity - **Volume**, Action - **Transform**).

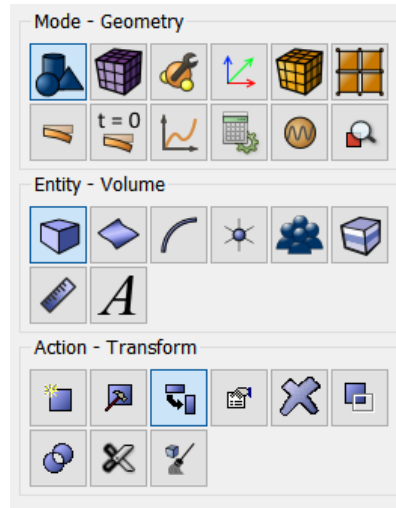

Select **Move** in the list of possible types. Set the following parameters:

- Volume ID(s): 1;
- Select Method: Distance;
- X Distance: 0.05.

Click **Apply**.

Meshing

1. Create the mesh of hexahedrons.

Select volume mesh generation section on Command Panel (Mode - **Mesh**, Entity - **Volume**, Action - **Mesh**).

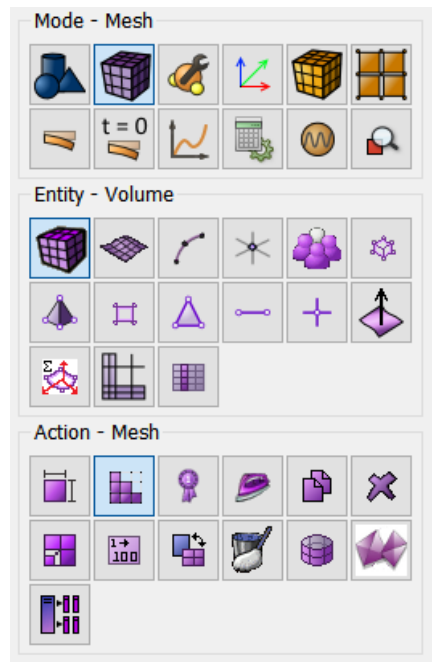

- The way of meshing: **Polyhedron**;
- Select Volumes (specify their ID): 1 (or by the command **all**).

Click **Apply Scheme**.

Click **Mesh**.

Setting material and block properties

1. Create the material

Select setting the material properties section on Command Panel (Mode - **Material**, Entity - **Materials Management**).

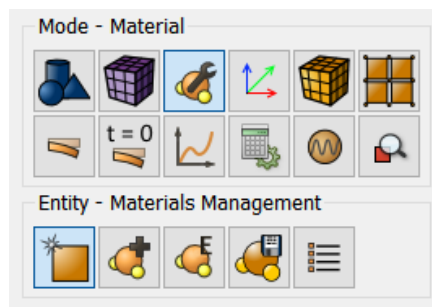

In the Materials Management window that opens, in the second column, click on the caption Enter the name of the material and write “Material 1”. Press the ENTER key.

Set the following parameters:

- Density: 7200;
- Specific Heat coefficient: 440.5;
- Thermal conductivity coefficient: 35.

Click **Apply**.

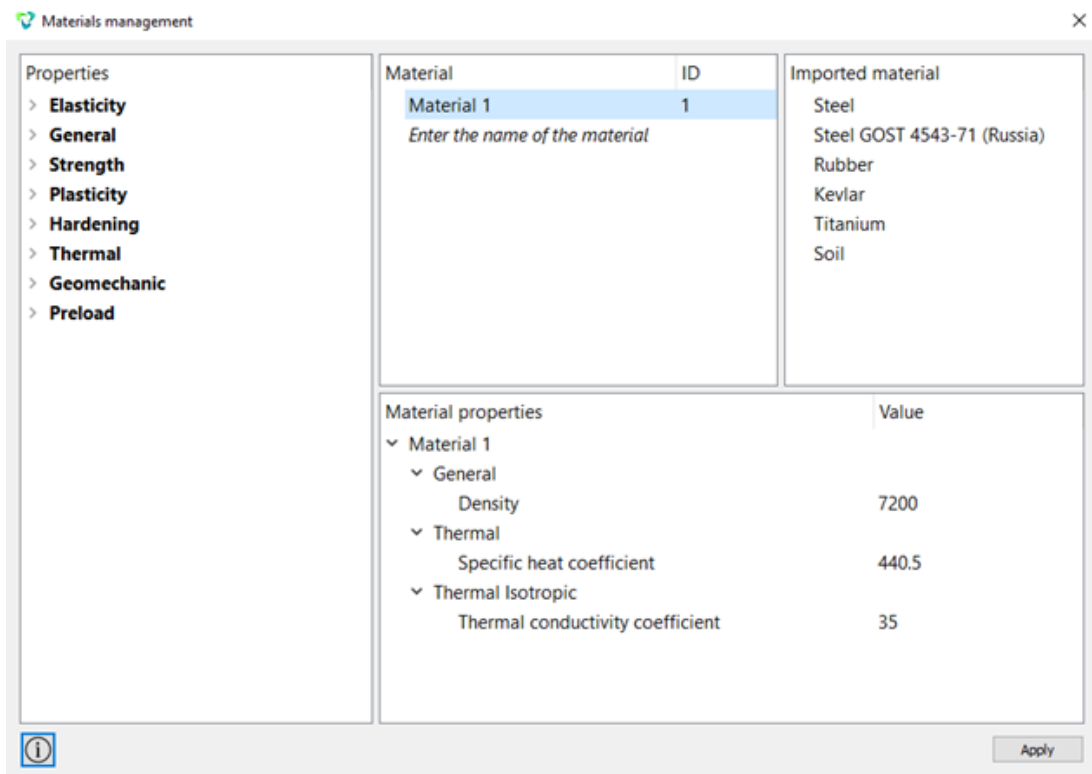

2. Create a block of one type of the material.

Select setting the material properties section on Command Panel (Mode - **Blocks**, Entity - **Block**, Action - **Add**).

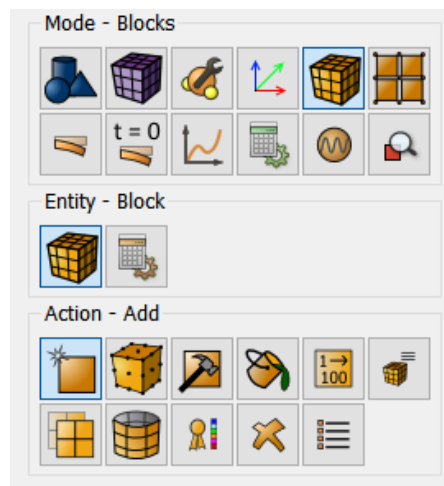

Select **Add** in the list of possible operations. Set the following parameters:

- Block ID: 1;
- Entity list: Volume;
- Entity ID(s): 1 (or by the command **all**).

Click **Apply**.

3. Set the block parameters.

On the command panel, select the mode for setting material properties (Mode - **Blocks**, Entity - **Block**, Action - **Block properties/parameters**).

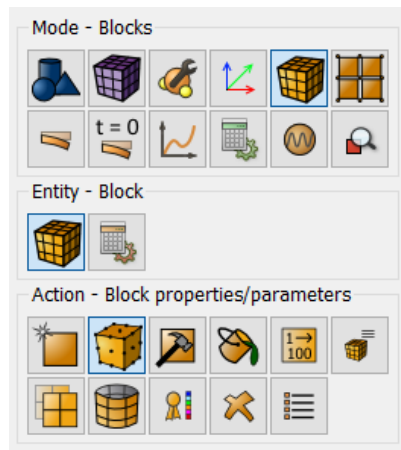

Set the following parameters:

- Block ID(s): 1;
- Category: Solid;
- Material: Material 1;
- Coordinate System: Global Cartesian;
- Order: 1.

Click **Apply**.

Setting boundary conditions

1. Set the value of temperature applied to the left side of the beam.

Select on Command Panel (Mode - **Boundary Conditions**, Entity - **Temperature**, Action - **Create**).

Set the following parameters:

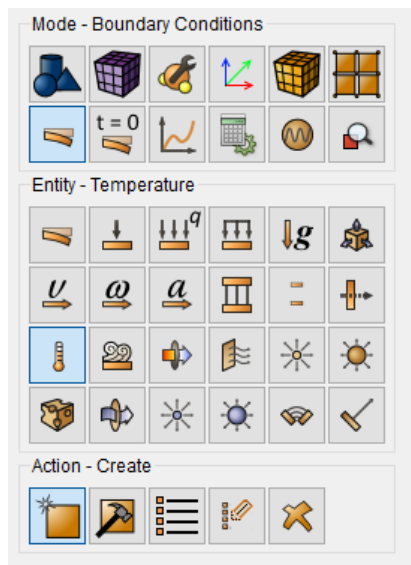

- System Assigned ID;
- Temperature Entity List: Surface;
- Entity ID(s): 4;

- Temperature Value: 0.

Click **Apply**.

2. Set the value of temperature applied to the right side of the beam.

Select on Command Panel (Mode - **Boundary Conditions**, Entity - **Temperature**, Action - **Create**).

Set the following parameters:

- System Assigned ID;
- Temperature Entity List: Surface;
- Entity ID(s): 6;
- Temperature Value: 1.

Click **Apply**.

Setting time dependency of boundary conditions

1. Set time dependency of the temperature applied to the right edge of the beam.

Select (Mode - **Boundary Conditions**). Click on the button **Time dependency** on Command Panel. The pop-up menu with the settings will be opened. On the left panel, select BC for which the time dependency will be set: **Temperature 2**. Set the following parameters:

- Time dependency type: Manually;
- Enter formula: $100 * \sin(0.0785 * t)$.

Click **Apply**.

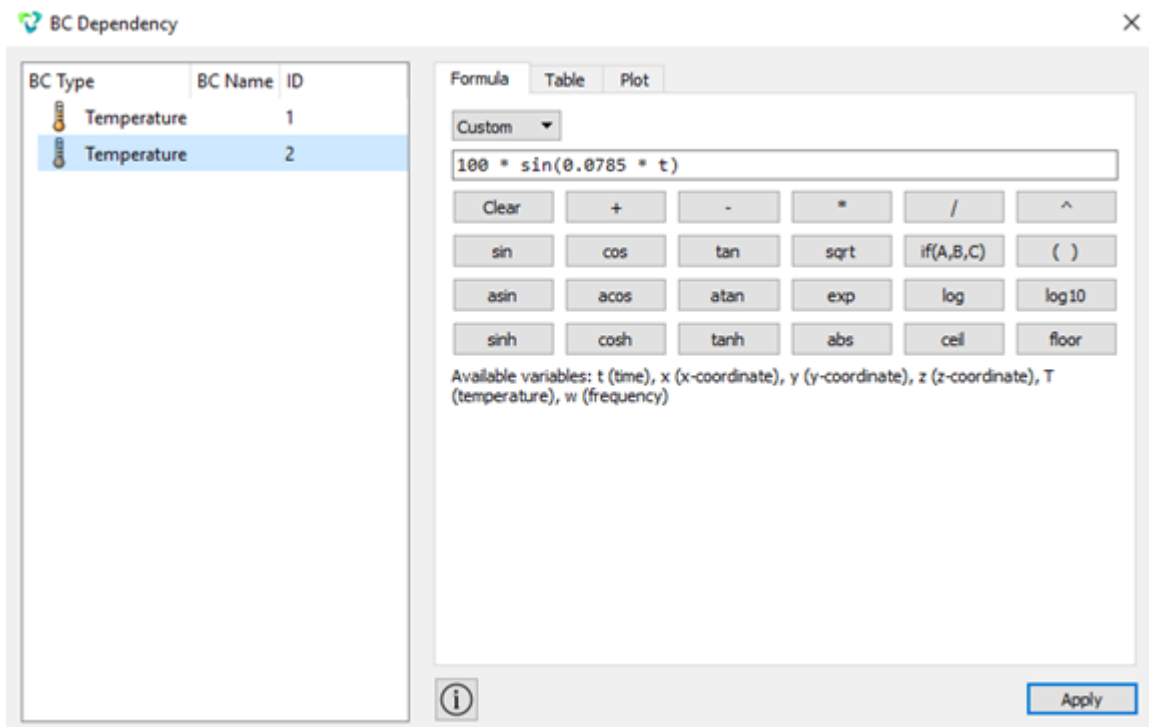

Starting calculation

1. Set the type of the problem to be solved.

Select calculation setting section on Command Panel (Mode — **Calculation Settings**, Calculation settings — **Transient analysis**, Transient — **General**).

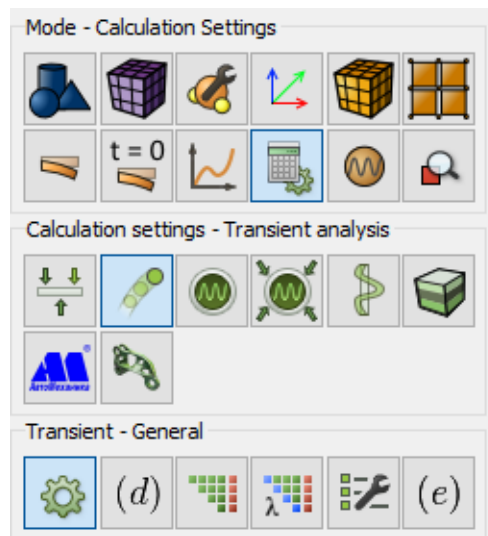

Set the following calculation parameters:

- Dimension: 3D;
- Method: Full solution;
- Scheme: Implicit;
- Max time: 32;
- Steps count: 10;
- Elasticity: untick;
- Heat transfer: tick.

Click **Apply**.

Click **Start Calculation**.

In a pop-up window select a folder to save the result and enter the file name.

If the calculation is finished successfully, you will see a message in the Console: “*Calculation finished successfully at <date> <time>*”.

Results analysis

1. Open the file with the results.

You can do this in one of the three ways:

- Click Ctrl+E.
- Select **Calculation Open Results** in the Main Menu. Click **Open last result**.
- Select **Results** on Command Panel (Mode **Results**). Click **Open last result**.

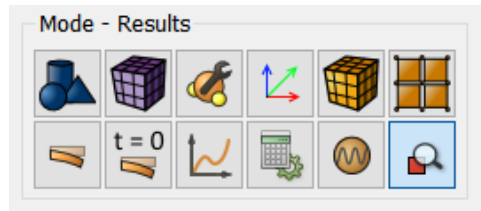

You can see the calculation results in the pop-up **Fidesys Viewer** window.

2. There is a menu on Toolbar which allows viewing animation. It consists of a cycle of solutions calculated for every moment of time. Click Last Frame • to see the model in time moment $t = 32^{\circ}\text{C}$.

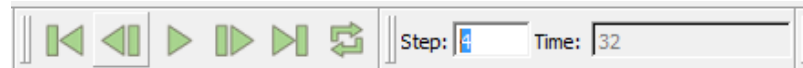

3. Display the component of the temperature.

In **Fidesys Viewer** window set the following parameters on Toolbar:

- Representation Field: Temperature;
- Representation Mode: Surface With Edges.

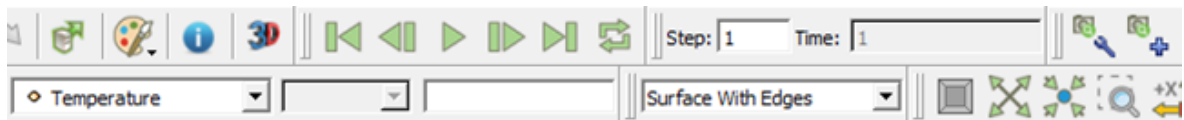

The model displays the mesh resulting from application of the spectral element method and the field of temperature distribution.



To display the color legend scale, click the button **Switch the color legend visibility** on Command Panel.

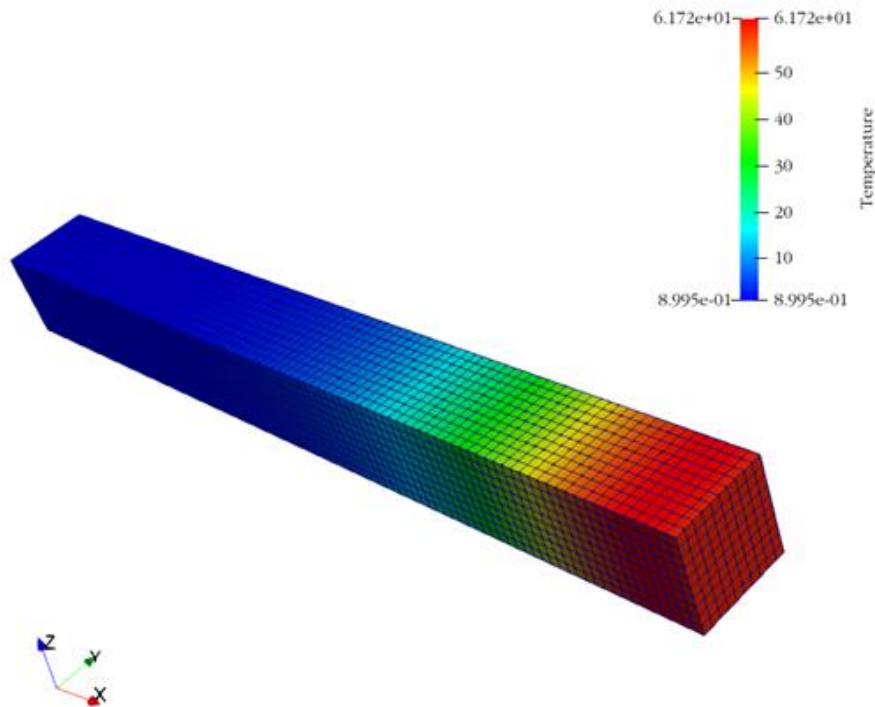

4. To graph along one of the beam edges.

Select the filter **Plot Over Line** in the Main Menu. Set the coordinates of the points defining the line In the tab **Properties**:

- Source: High Resolution Line;
- Show Line;
- Point 1 (coordinates): 0 -0.005 0.005;
- Point 2 (coordinates): 0.1 -0.005 0.005;
- Resolution: 100;
- PassPartialArrays.

Click **Apply**.

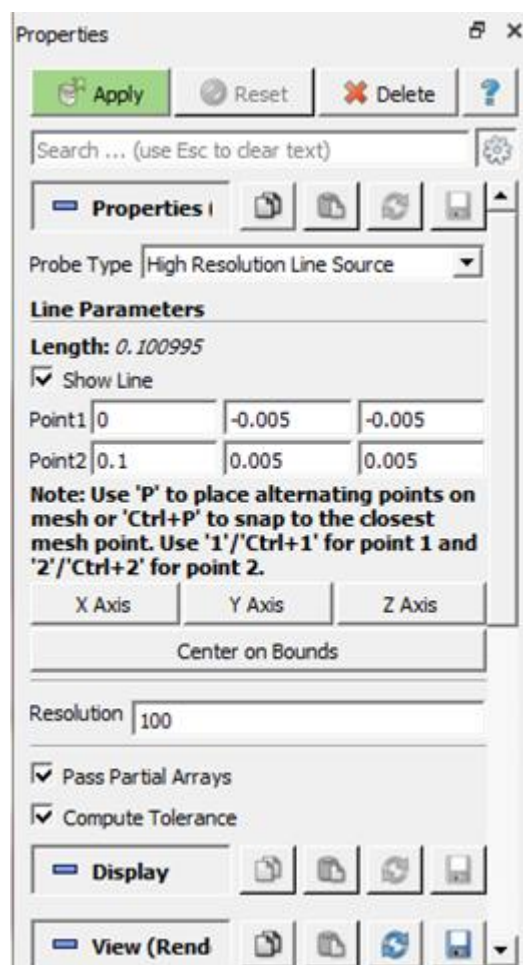

To apply all of the filters changes automatically, click **Apply changes to parameters automatically** on Command Panel.

Click on the graph window appeared on the right side of the screen.

5. Display temperature change on the graph.

Click on the graph window, go to the tab "Display" in the filter control panel.

Set the **Attribute Mode - Point Data**

Next, in the field “Line Series”, set up labels against the parameters that you want to display on the graph.

Untick all the options except Temperature.

The temperature dependency at points belonging to the beam edge and the coordinates of these point coordinates are displayed on the graph.

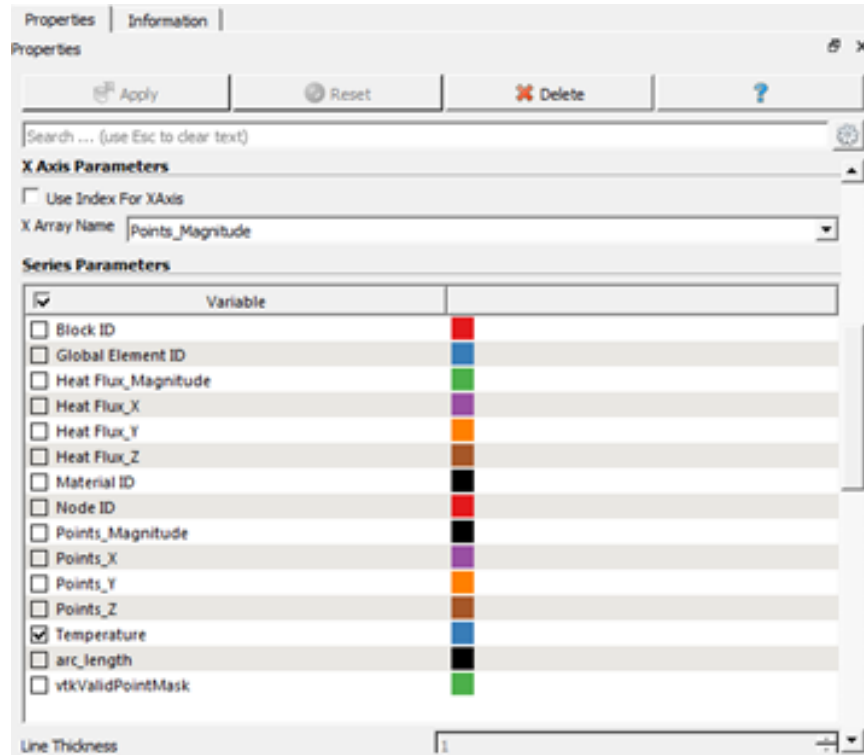

6. Check the numerical temperature value T at the point (0.08;0;0).

Move the cursor to the required point on the graph. You can see a tool tip with the temperature value.

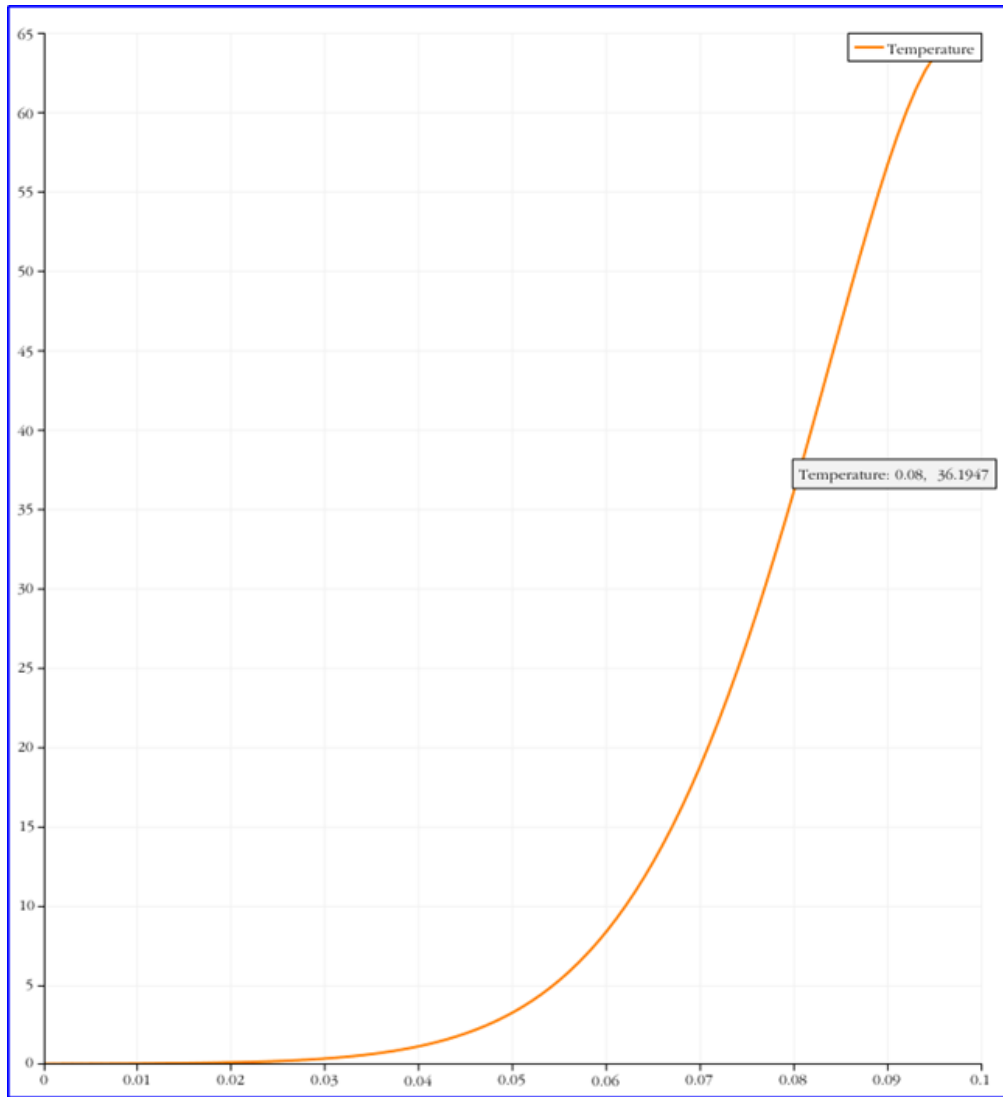

7. Download numerical data.

Select → **File Save Data** in the Main Menu or click **Ctrl+S**. Enter the file name (*.csv format), leave it by default. Click **OK**. The saved file is an ordinary table of numerical data which can be opened in any text editor.

Using Console Interface

For geometry generation, meshing, setting boundary conditions and materials you can use Console Interface.



It is also possible to run the file *tutorial_dynamics_thermo.jou* by selecting Journal Editor on Toolbar. In a pop-up window of the main menu select **File** → **Open** and open the necessary journal file.

Harmonic analysis (beam model)

We consider an example with a beam construction. Structural damping is specified.

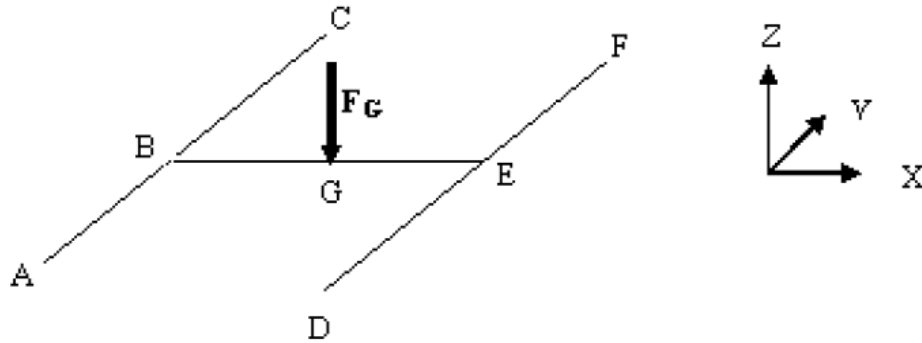

The model is rigidly fixed at points A, D, C, F. A force dependent on frequency is applied to the middle of the BE face. The sides of the structure have the same length: $AB = BC = DE = EF = BG = EG = 2.5$ m. Material parameters: Young's modulus $E = 2e11$ Pa, Poisson's ratio $\nu = 0.3$, density $\rho = 7800$ kg / m³. Structural damping 0.1 is specified

Geometry creating

1. Create a structure and beams (lines).

Since the structure contains edges of the same length, use the parameter $L = 2.5$. To set a parameter, enter in the command line # {L = 2.5}.

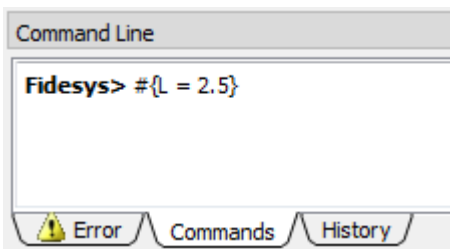

On the toolbar, select a line creating mode (Mode - **Geometry**, Entity - **Curve**, Action - **Create**).

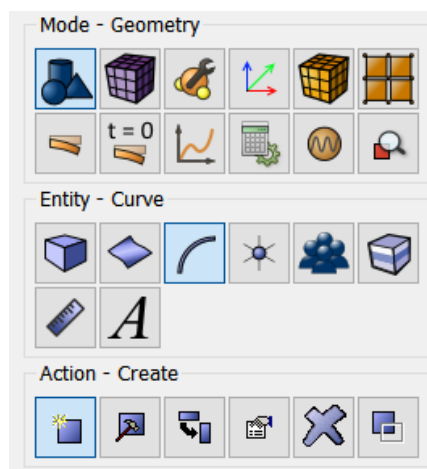

From the drop-down list, select **Line**. On the **Build** panel, use select **Location and Direction**. Next, enter the necessary data to create the first line:

- Location: 0 0 0 (space separated);
- Direction: 0 1 0;
- Length: {L}.

Click **Apply**.

Specify the necessary data to create a second line:

- Location: 0 {L} 0;
- Direction: 0 1 0;
- Length: {L}.

Location	0 {L} 0	...
Direction	0 1 0	...
Length	{L}	

Click **Apply**.

Specify the necessary data to create a third line:

- Location: 0 {L} 0;
- Direction: 1 0 0;
- Length: {L}.

Location	0 {L} 0	...
Direction	1 0 0	...
Length	{L}	

Click **Apply**.

Specify the necessary data to create the fourth line:

- Location: {L} {L} 0;
- Direction: 1 0 0;
- Length: {L}.

Location	{L} {L} 0	...
Direction	1 0 0	...
Length	{L}	

Click **Apply**.

Specify the necessary data to create a fifth line:

- Location: {2 * L} 0 0;

- Direction: 0 1 0;
- Length: {L}.

Location	<input type="text" value="{2*L} 0 0"/>	...
Direction	<input type="text" value="0 1 0"/>	...
Length	<input type="text" value="{L}"/>	

Click **Apply**.

Specify the necessary data to create the sixth line:

- Location: {2 * L} {L} 0;
- Direction: 0 1 0;
- Length: {L}.

Location	<input type="text" value="{2*L} {L} 0"/>	...
Direction	<input type="text" value="0 1 0"/>	...
Length	<input type="text" value="{L}"/>	

Click **Apply**.

2. Splicing tops on received beams. On the toolbar, select the vertex creating mode (Mode - **Geometry**, Entity - **Vertex**, Action - **Merge**).

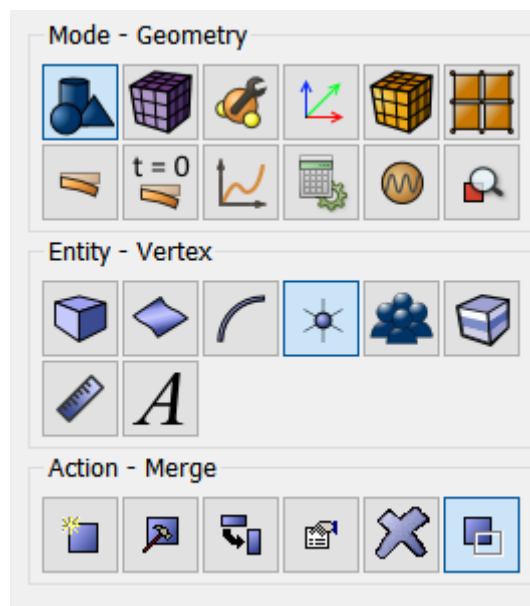

Specify:

- Vertex ID(s): all.

Click **Apply**.

A beam structure was created.

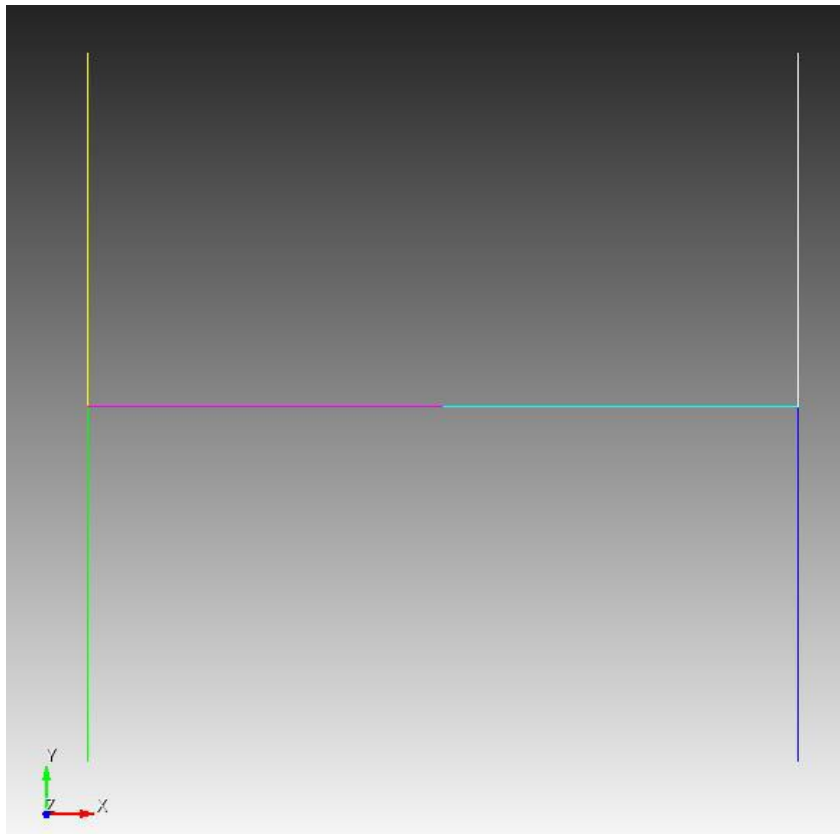

Meshing

1. On the command panel, select the volume mesh mode (Mode - **Mesh**, Entity - **Curve**, Action - **Mesh**).

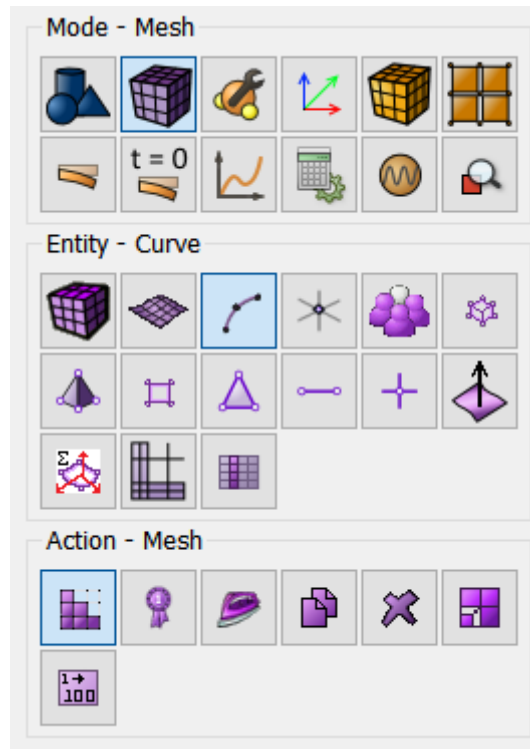

Specify the following parameters:

- Select Curves: all;
- Settings for Curve: Equal;
- Approximate Size: 0.1.

Click **Apply Size**.

Click **Mesh**.

Setting material and block properties

1. Create a material.

Select setting the material properties section on Command Panel (Mode -**Material**, Entity -**Materials Management**).

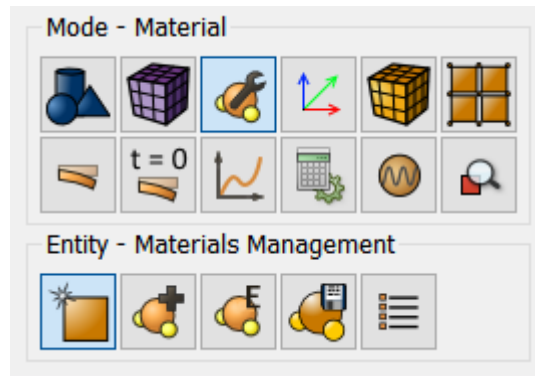

In the Materials Management window that opens, in the second column, click on the caption Enter the name of the material and write Material 1. Press the ENTER key.

In the left column, select Elasticity - Hook Material. Select with the mouse the characteristic Young's modulus. Hold down the left mouse button and drag the label to Material Properties. Double-click in the Value field next to Young's modulus and enter the number $2e11$. Similarly, from the Hook Material section add the Poisson Ratio 0.3, Density: 7800.

Click **Apply**.

Close the window.

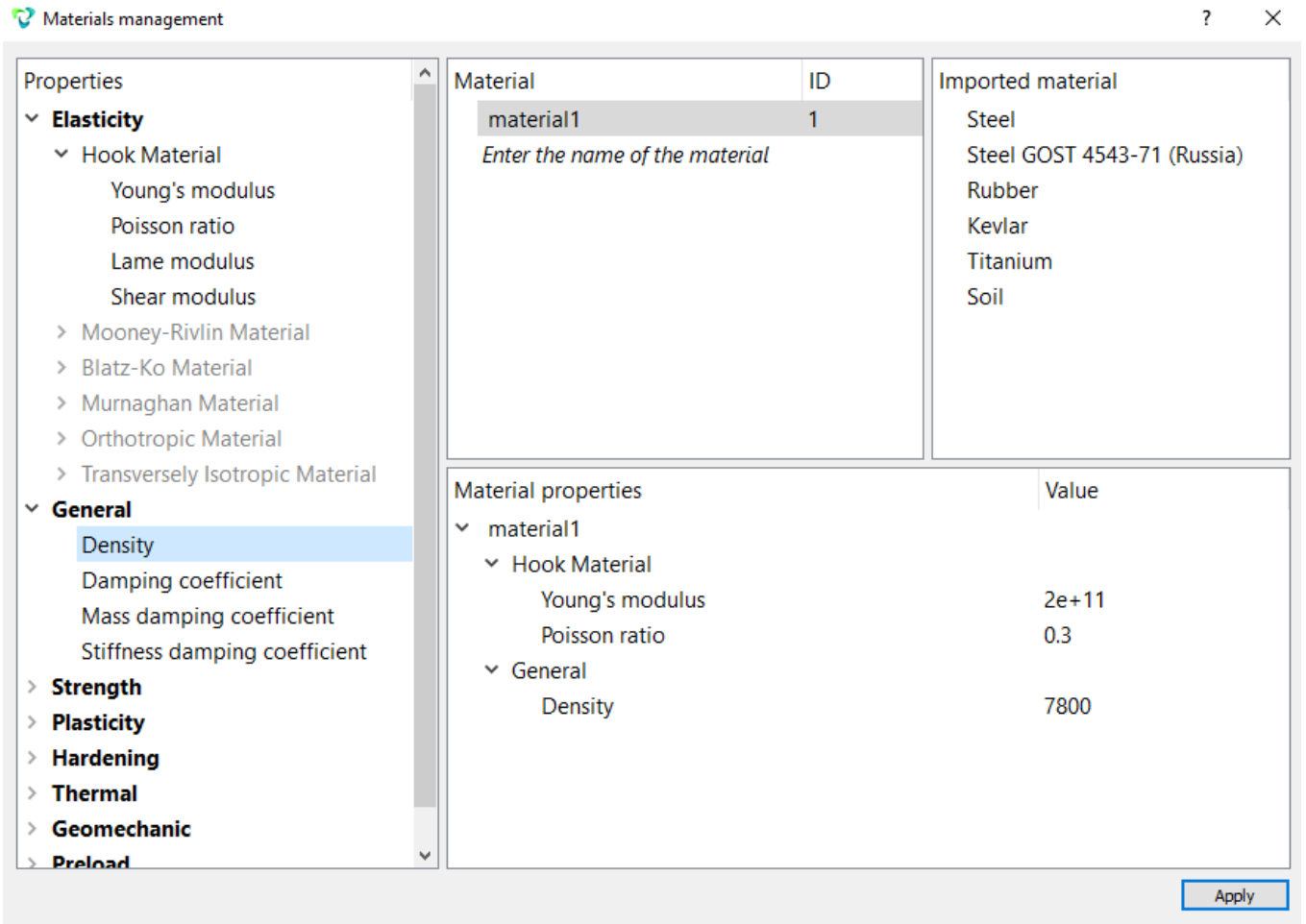

2. Create a block of the one type of material.

On the command panel, select the mode for setting material properties (Mode - **Blocks**, Entity - **Block**, Action - **Add**).



Set the following parameters:

- Block ID: 1;

- Entity List: Curve;
- Entity ID(s): all.

Click **Apply**.

3. Set the block parameters.

On the command panel, select the mode for setting material properties (Mode - **Blocks**, Entity - **Block**, Action - **Block properties/parameters**).

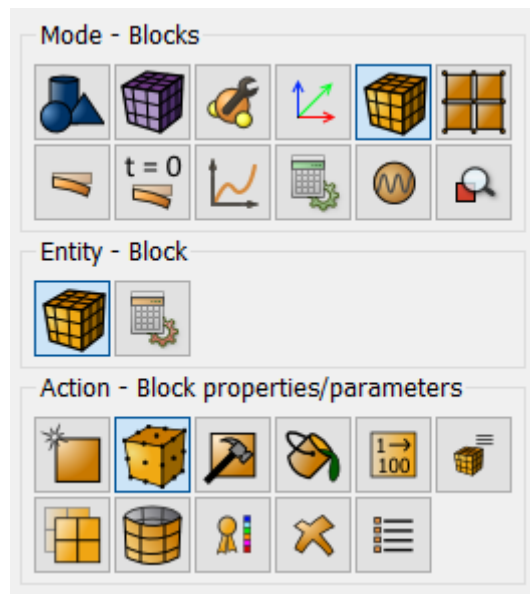

Set the following parameters:

- Block ID(s): 1;
- Category: Beam;
- Material: Material 1;
- Coordinate System: Global Cartesian;
- Order: 1.

Click **Set Beam Properties**. Set the checkbox **Select profile**. Select **Rectangle** in the list of geometric elements. Specify the following parameters:

- CS rotation angle: 0;
- Offset to: Centroid;
- Select profile: Ellipse;
- Minor axis (b): 0.1;
- Major axis (a): 0.1.

Click **Apply**.

Close the window **Set Beam Properties**.

Click **Apply**.



Set the following parameters:

- System Assignment ID;
- Force Entity List: Vertex;
- Entity ID(s): 6 (or select a vertex with the mouse, as shown in the figure);
- Force: 1;
- Direction: 0 0 -1 (negative direction along the z axis).

Click **Apply**.

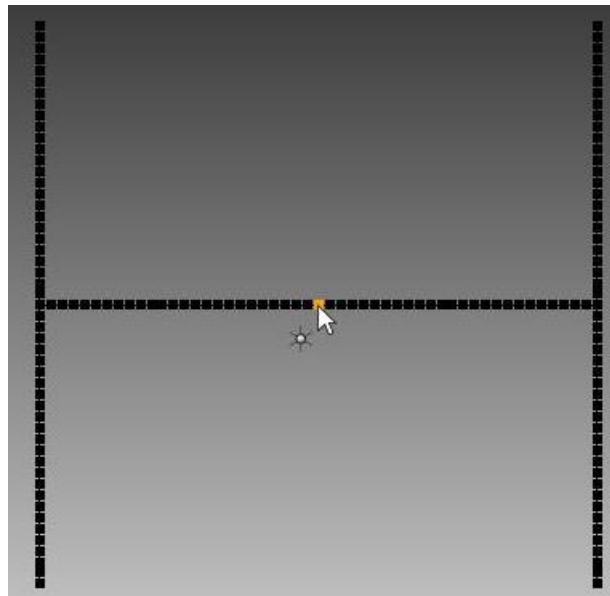

3. Set the frequency dependence.

On the command panel, select (Mode - **BC Dependency**).

In the BC Dependency window that appears, select the boundary condition Force 1 in the left column, in the Formula panel from the drop-down list, select Harmonic.

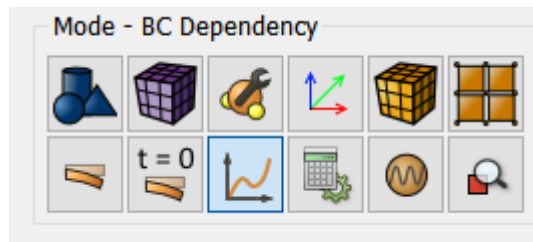

Enter the following data:

- Amplitude: 1e5;
- Phase: 0.

Click **Apply**.

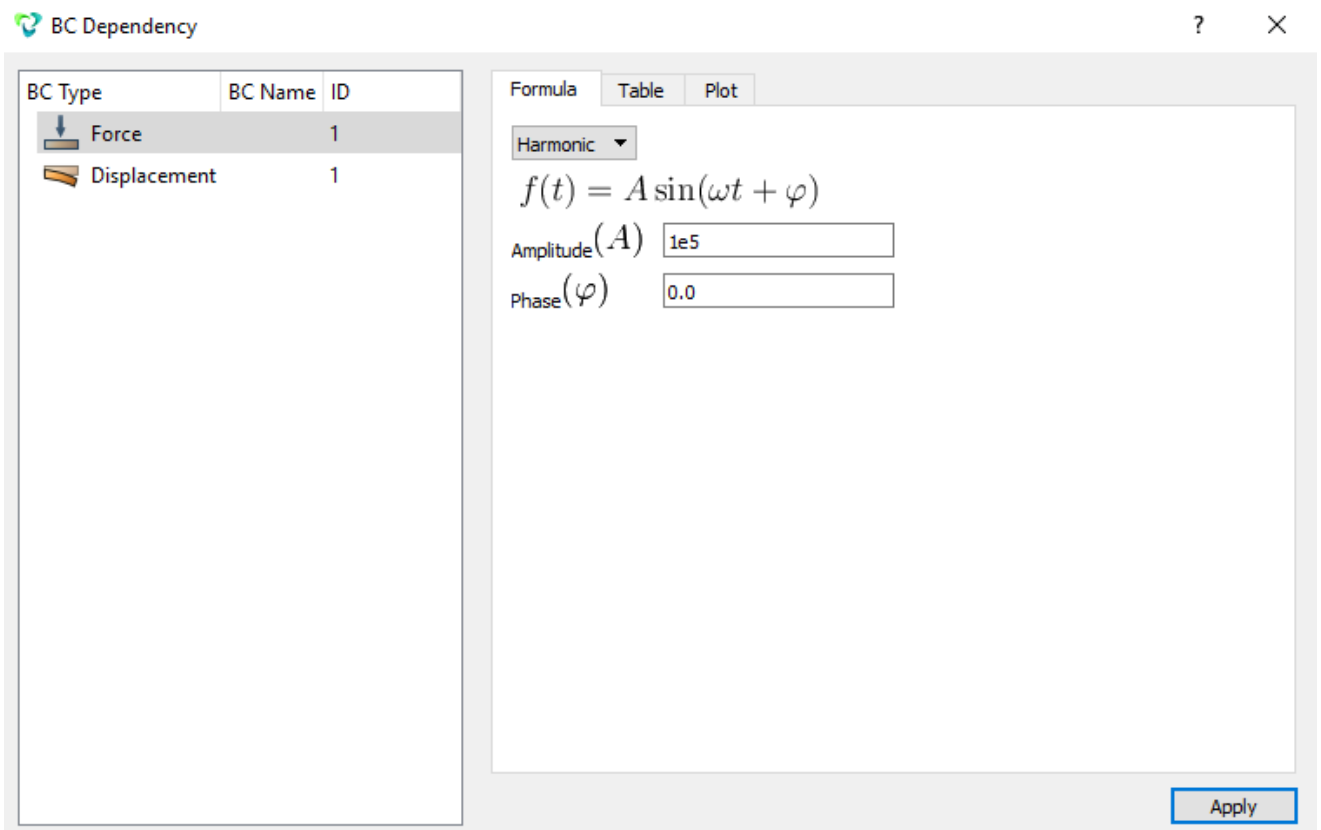

Starting calculation

1. Set the type of problem you want to solve.

On the command panel, select the calculation settings module (Mode - **Calculation Settings**, Calculation Settings - **Frequency analysis**, Frequency analysis - **General**).

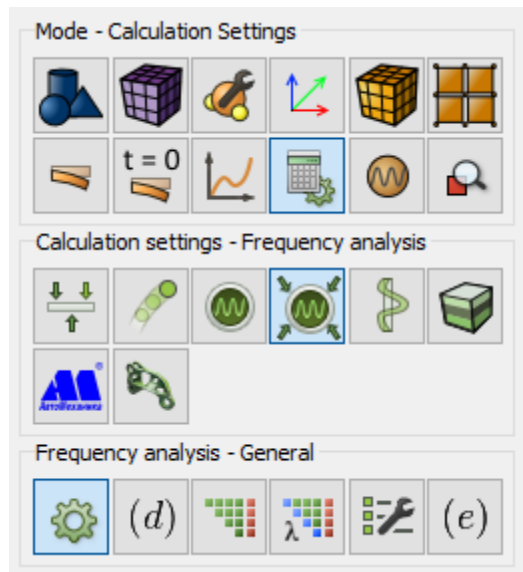

Set the following calculation parameters:

- Dimension: 3D;
- Method: Mod superposition;
- Maximum frequency number: 10;
- Frequency Interval: 0-200;
- Frequency step: 0.5.

Click **Apply**.

2. Specify structural damping.

On the command panel, select the calculation settings module (Mode - **Calculation Settings**, Calculation Settings - **Frequency analysis**, Frequency analysis - **Damping**).

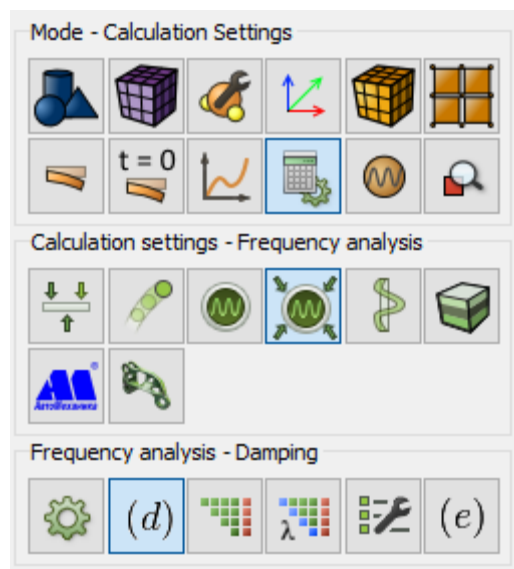

Set the following calculation parameters:

- Structural damping: 0.1.

Click **Apply**.

Click **Start Calculation**.

3. In the window that appears, select the directory in which the result will be stored, and enter the file name.

4. In the case of a successful calculation, the console displays the message: “*Calculation finished successfully at <date> <time>*”.

Results analysis

1. Compare the results displayed on the command line with the results below:

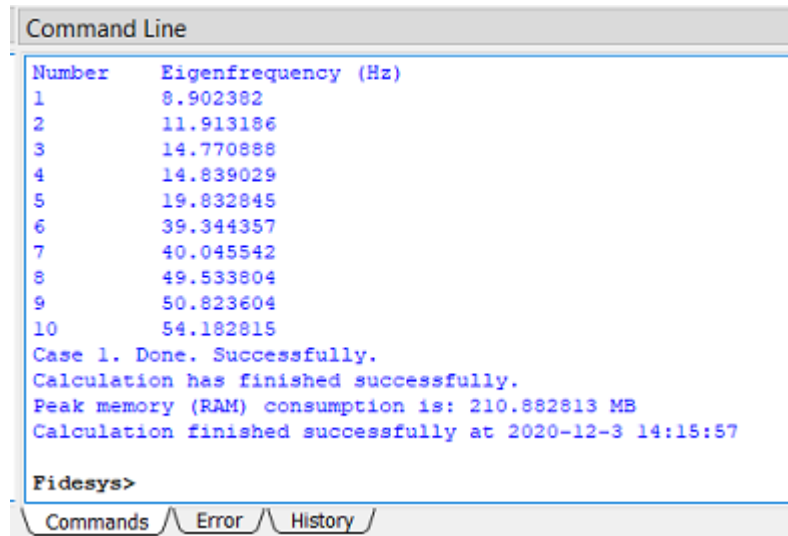

```
Command Line
Number      Eigenfrequency (Hz)
1           8.902382
2           11.913186
3           14.770888
4           14.839029
5           19.832845
6           39.344357
7           40.045542
8           49.533804
9           50.823604
10          54.182815
Case 1. Done. Successfully.
Calculation has finished successfully.
Peak memory (RAM) consumption is: 210.882813 MB
Calculation finished successfully at 2020-12-3 14:15:57

Fidesys>
Commands | Error | History
```

2. Open the file with the results.

You can do this in one of the three ways:

- Click **Ctrl+E**.
- Select **Calculation Open Results** in the Main Menu. Click **Open last result**.
- Select **Results** on Command Panel (Mode - **Results**). Click **Open last result**.

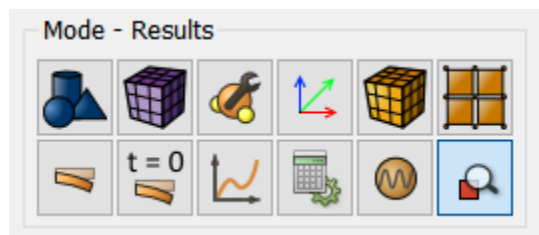

The **Fidesys Viewer** window will appear, in which you can view the calculation results.

In the standard line, select **Filters -> Alphabetical -> Harmonic Analysis**.

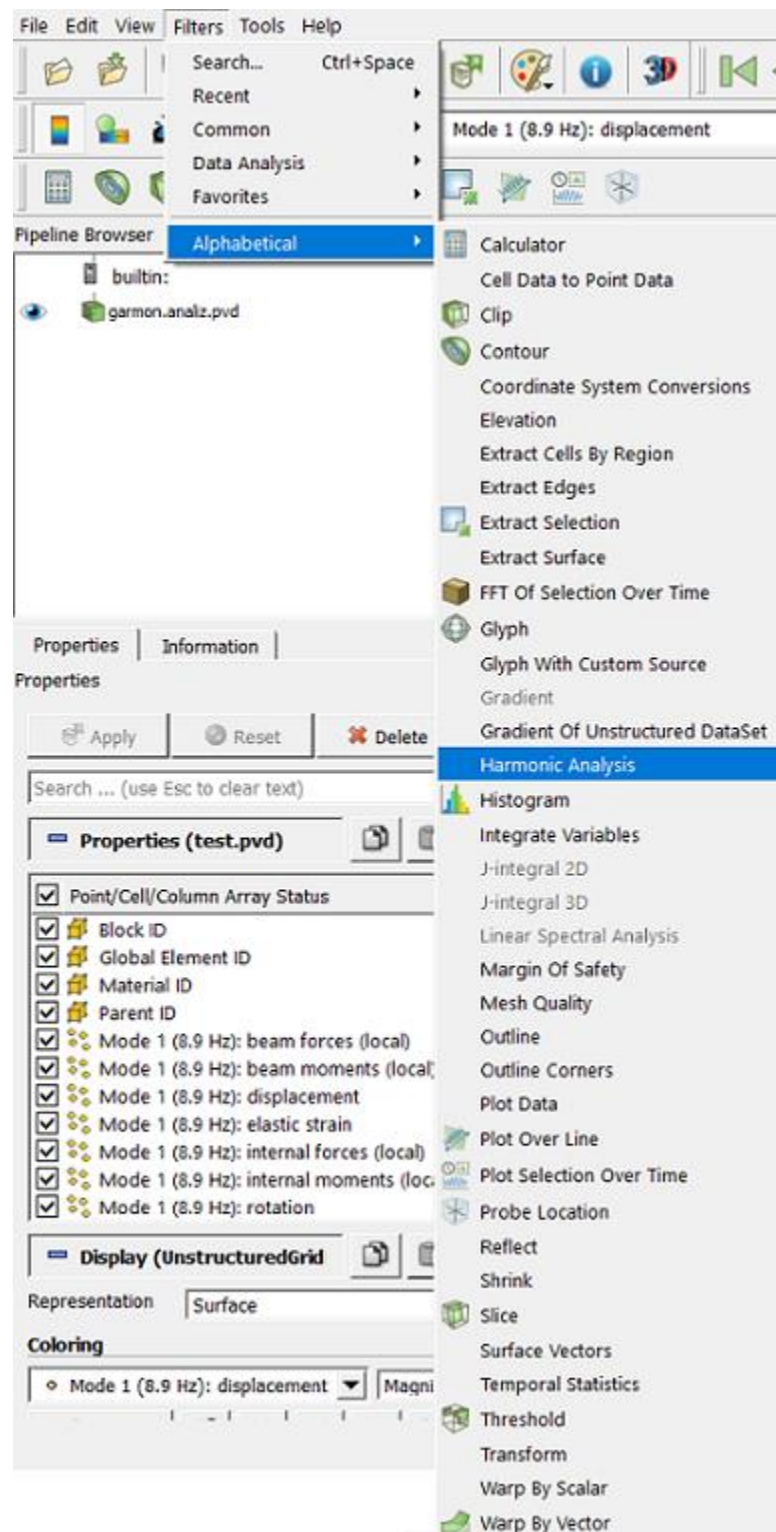

The plot of Displacement (Amplitude) versus frequency must be plotted for node 2 (coincides with vertex B). For the Harmonic analysis filter in the Tree, in the Properties tab, specify:

- Node ID: 2.

Click **Apply**.

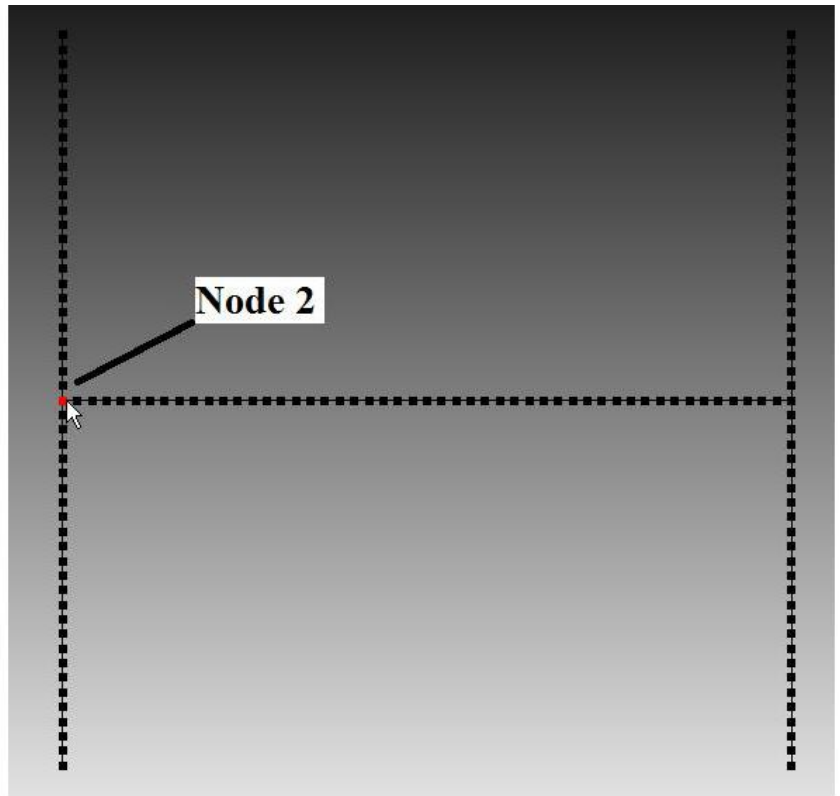
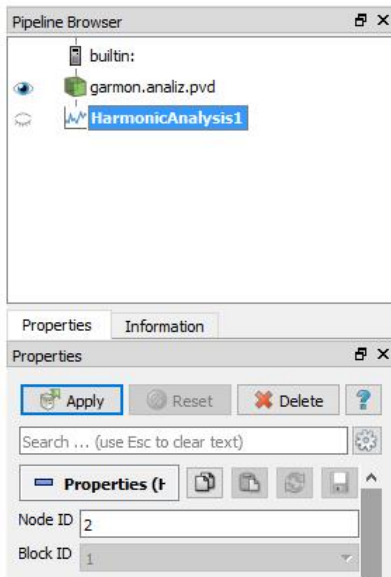

In the section Row Parameters for the X-axis that appears, select only the Displacement Amplitude Z (Harmonic Analysis).

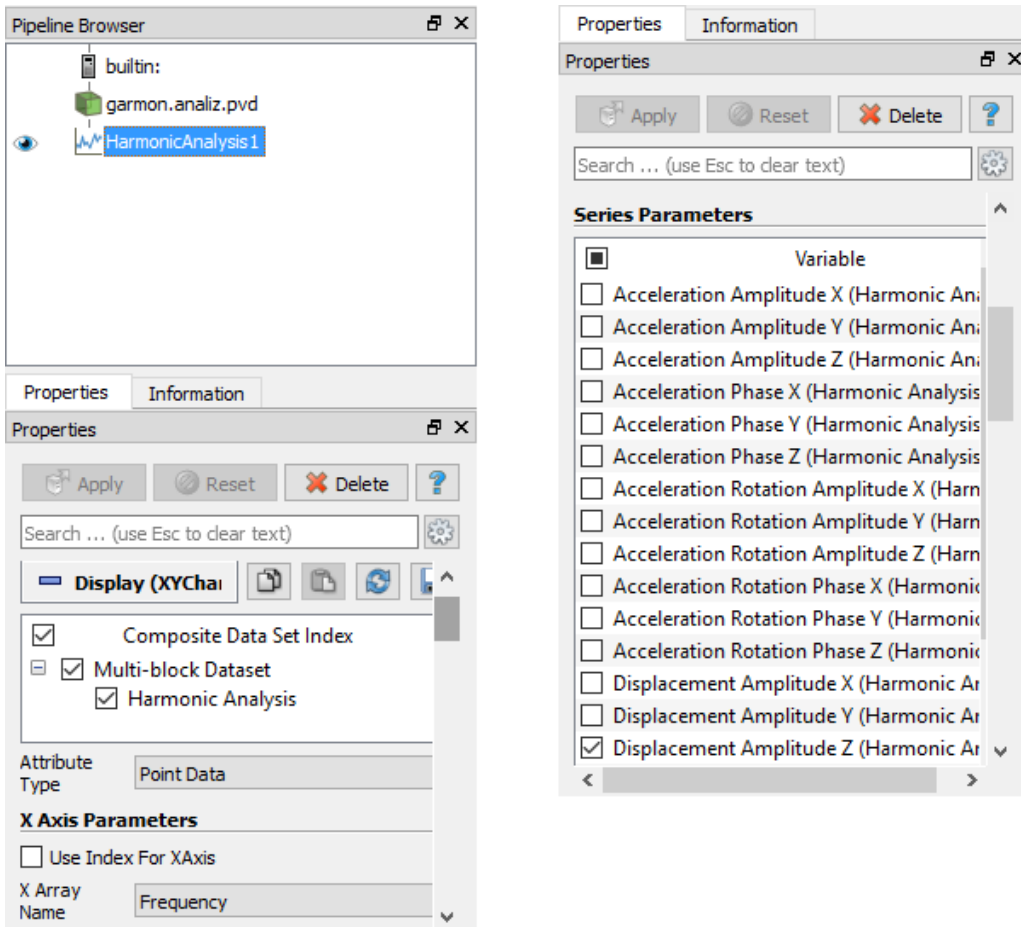

On the right side of the screen received the desired graph.

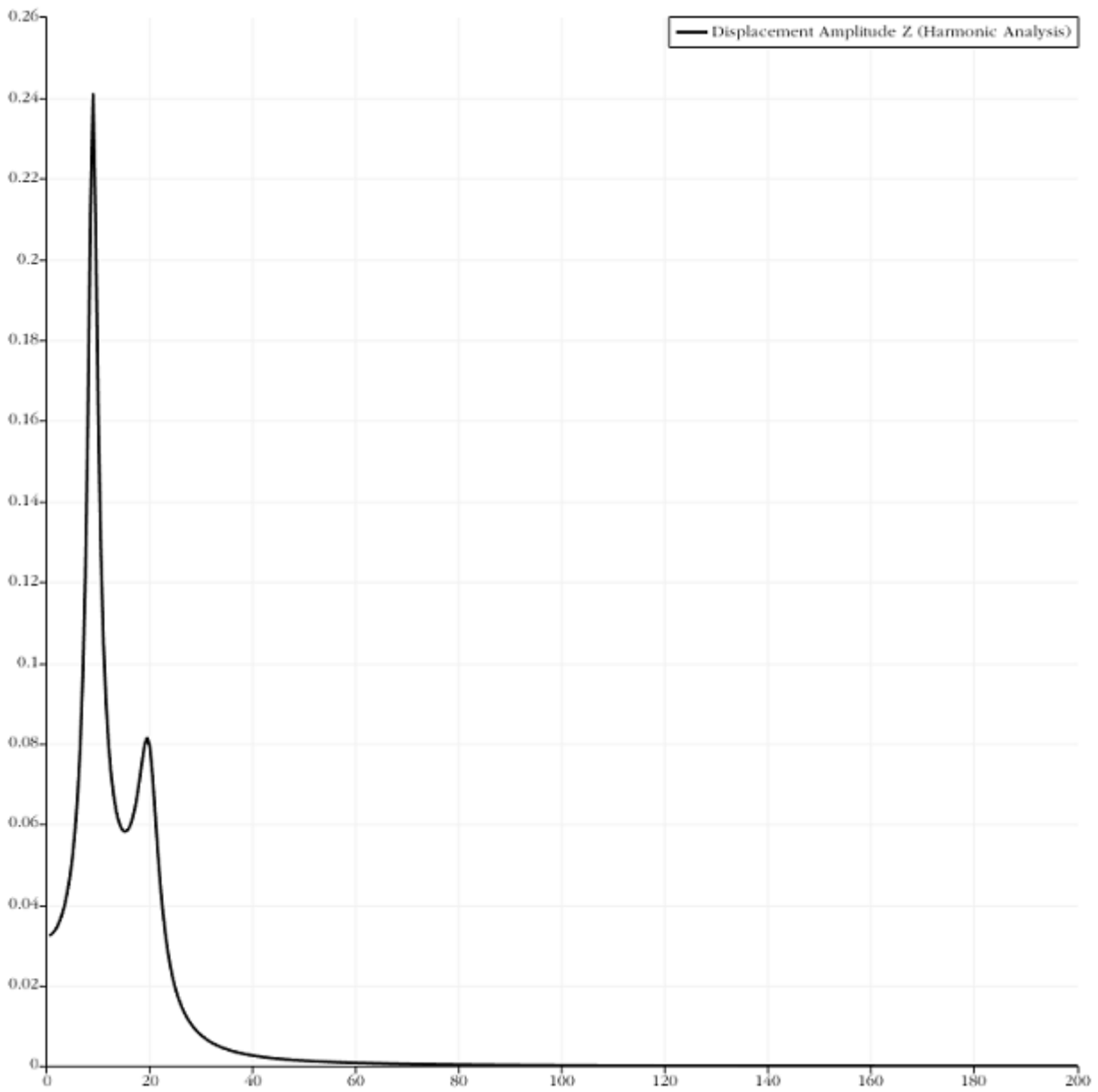

Hover over one of the peaks, then the pop-up text will display the amplitude value corresponding to the frequency.

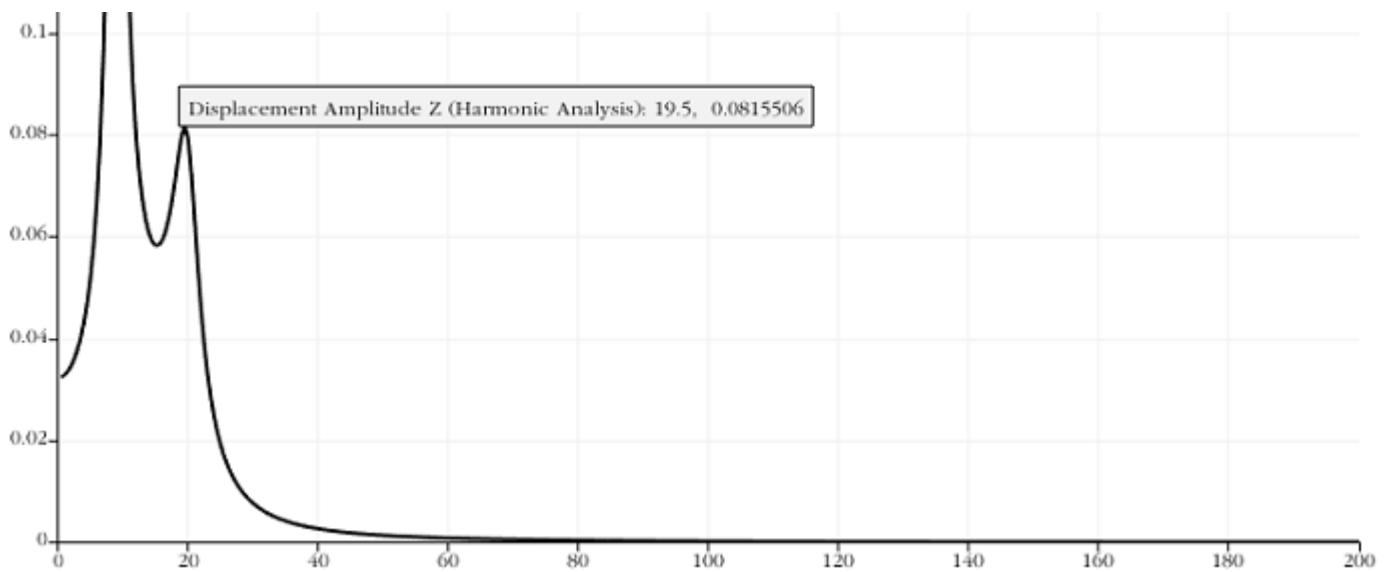

Using the console interface

For geometry generation, meshing, setting boundary conditions and materials you can use Console Interface.



It is also possible to run the file *harmonic_beam.jou* by selecting Journal Editor on Toolbar. In a pop-up window of the main menu select **File** → **Open** and open the necessary journal file.

Bounded Contact Simulation

We consider an example of the calculation of a structure consisting of several volumes that are not merged with each other. There is a geometric gap between the two volumes, so instead of “gluing” the volumes, the bounded contact will be used. The model represents a quarter of the original part.

The model is located here:

C:\Program Files\Fidesys\CAE-Fidesys-4.1\preprocessor\bin\help\fidesys_example_tutorials\modeling_contact\images\geom_example_contact.stp

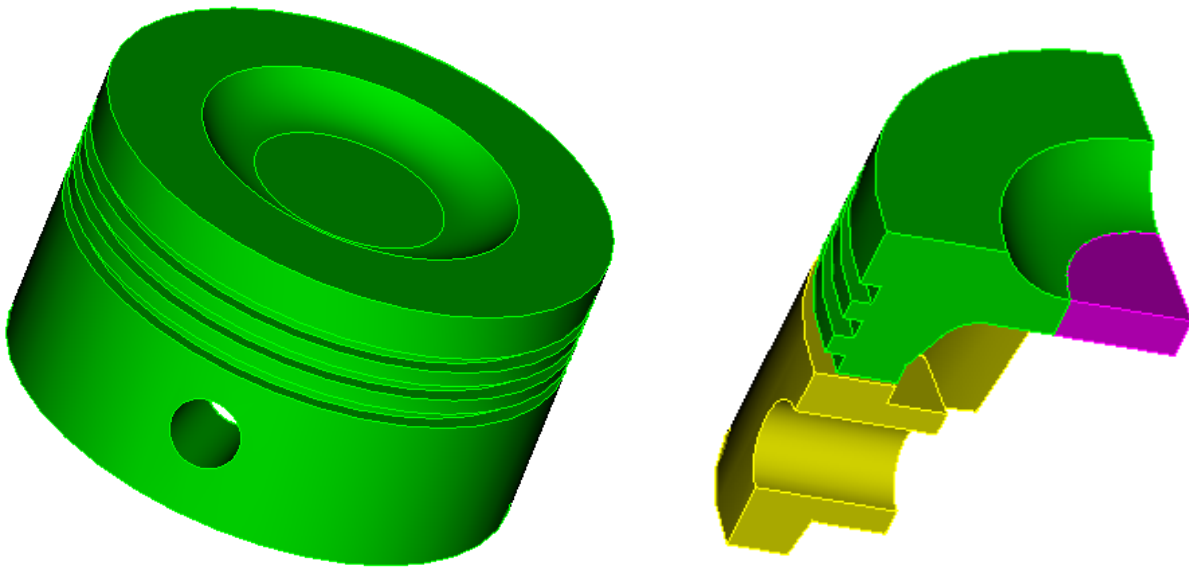

The model is fixed on the lateral faces of the symmetry conditions. The inner surface of the hole is fixed in all degrees of freedom. A pressure of 1 MPa is applied to the upper face of the part. Material parameters: Young's modulus $E = 2e11$ Pa, Poisson's ratio $\nu = 0.3$.

Geometry creation

1.Import geometry

In the standard line select Menu - File - Import. Specify the path to the `Geom_example_contact.stp` file. In the window that appears, click Finish with all the default values of settings.

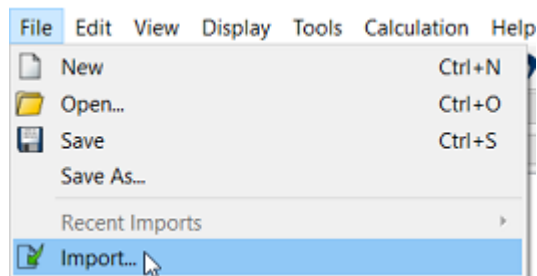

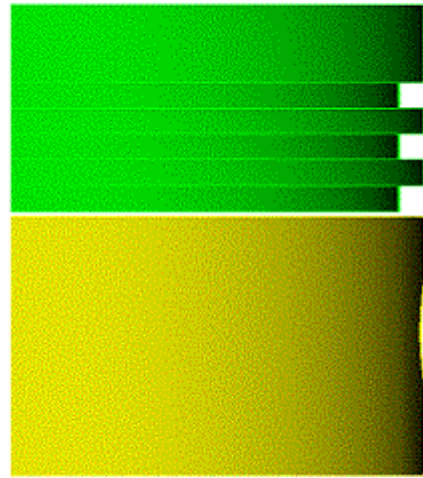
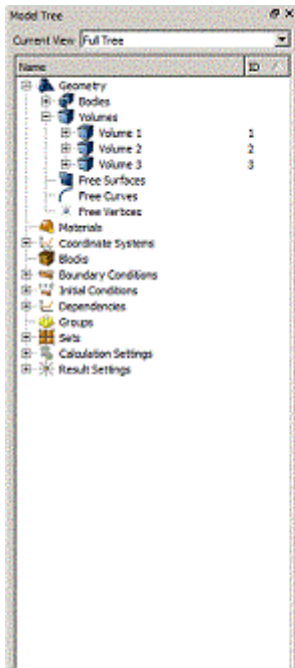

In the Tree on the left you can see three volumes into which the model is separated. All three volumes have no common surfaces.

Meshing

1. On the command panel, select the volume mesh mode (Mode — **Mesh**, Entity — **Volume**, Action — **Intervals**).

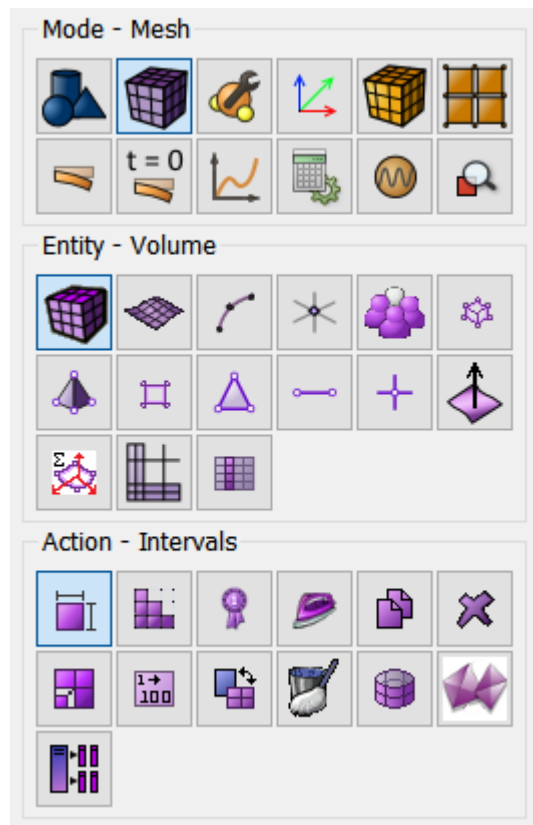

Specify the following parameters:

- In the drop-down list, select: Approximate size;
- Choice of volumes: 1;
- Approximate size: 0.1.

Click **Apply Size**.

Click **Mesh**.

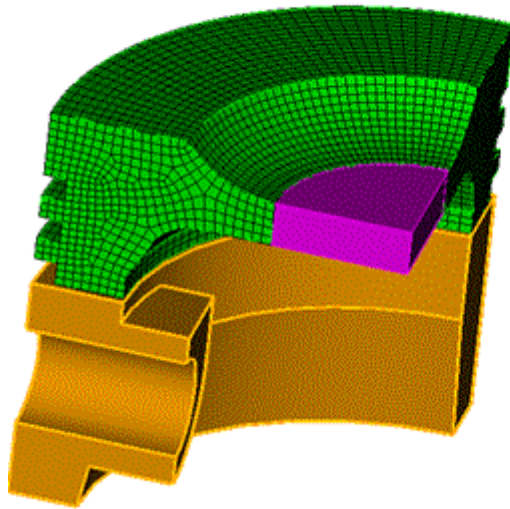

2. On the command bar, select the volume mesh building mode (Mode — **Mesh**, Entity — **Volume**, Action — **Intervals**).

Specify the following parameters:

- In the drop-down list, select: Approximate size;
- Select volumes: 2;
- Approximate size: 0.3.

Click **Apply Size**.

Click **Mesh**.

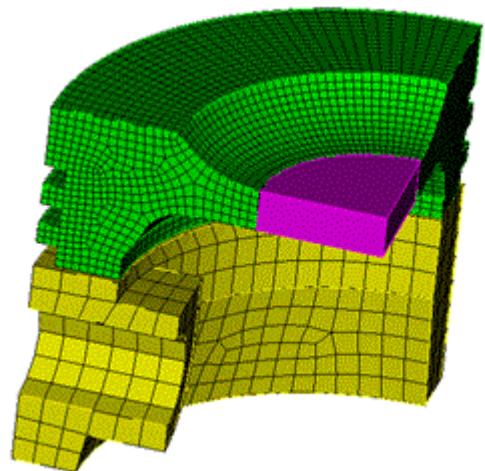

3. On the command panel, select the volume mesh creating mode (Mode — **Mesh**, Entity — **Volume**, Action — **Intervals**). Specify the following parameters:

- In the drop-down list, select: Approximate size;
- Select volumes: 2;

- Approximate size: 0.3.

Click **Apply Size**.

Click **Mesh**.

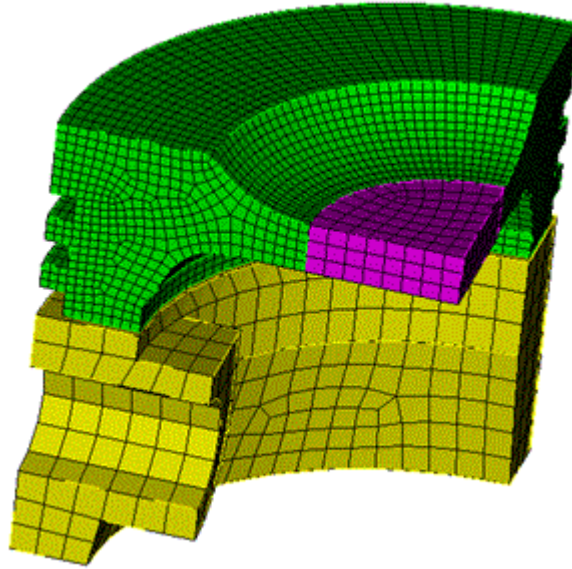

Thus, a non-conformal finite element mesh was created on the model.

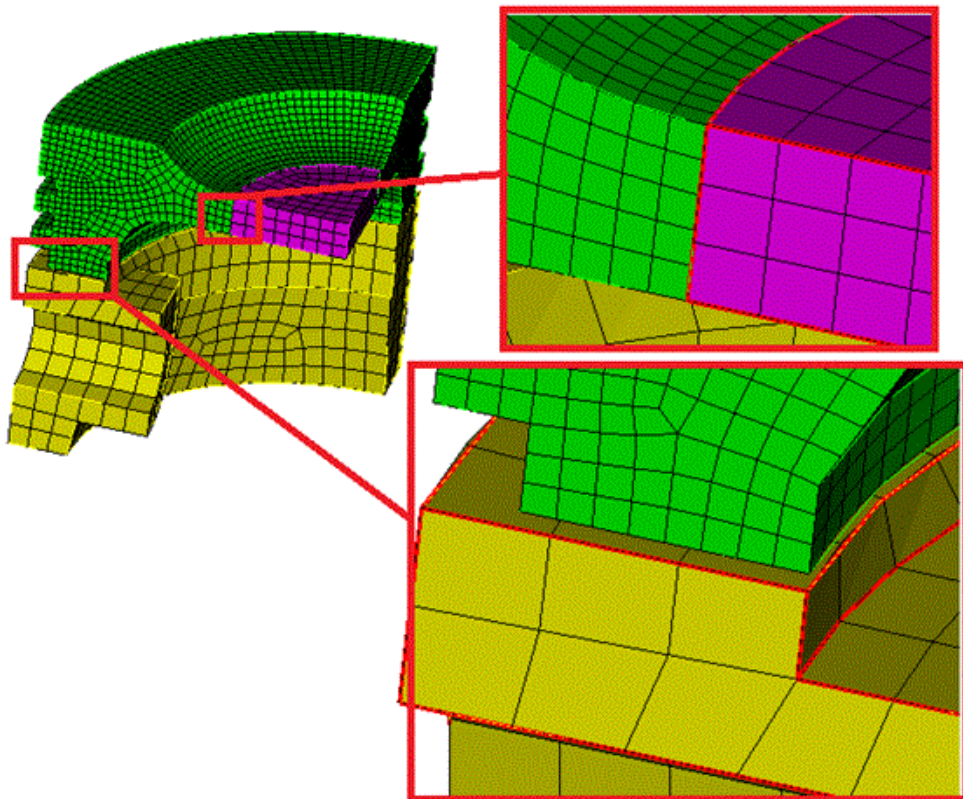

Specifying the material and block properties

1. Create a material.

Select setting the material properties section on Command Panel (Mode — **Material**, Entity — **Materials Management**).

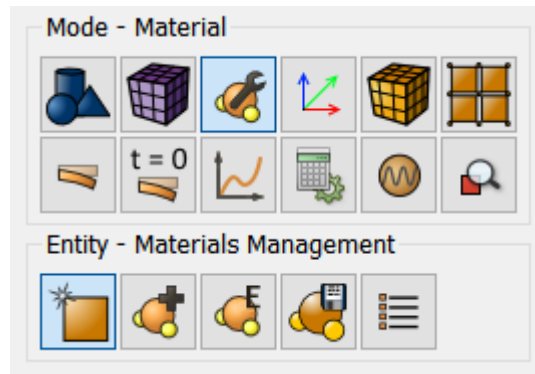

In the Materials Management window that opens, in the second column, click on the caption Enter the name of the material and write "Material 1". Press the ENTER key.

In the left column, select Elasticity - Hook Material. Select with the mouse the characteristic Young's modulus. Hold down the left mouse button and drag the label to Material Properties. Double-click in the Value field next to Young's modulus and enter the number 2e11. Similarly, from the Hook Material section add the Poisson Ratio 0.3

Click **Apply**. Close the window.

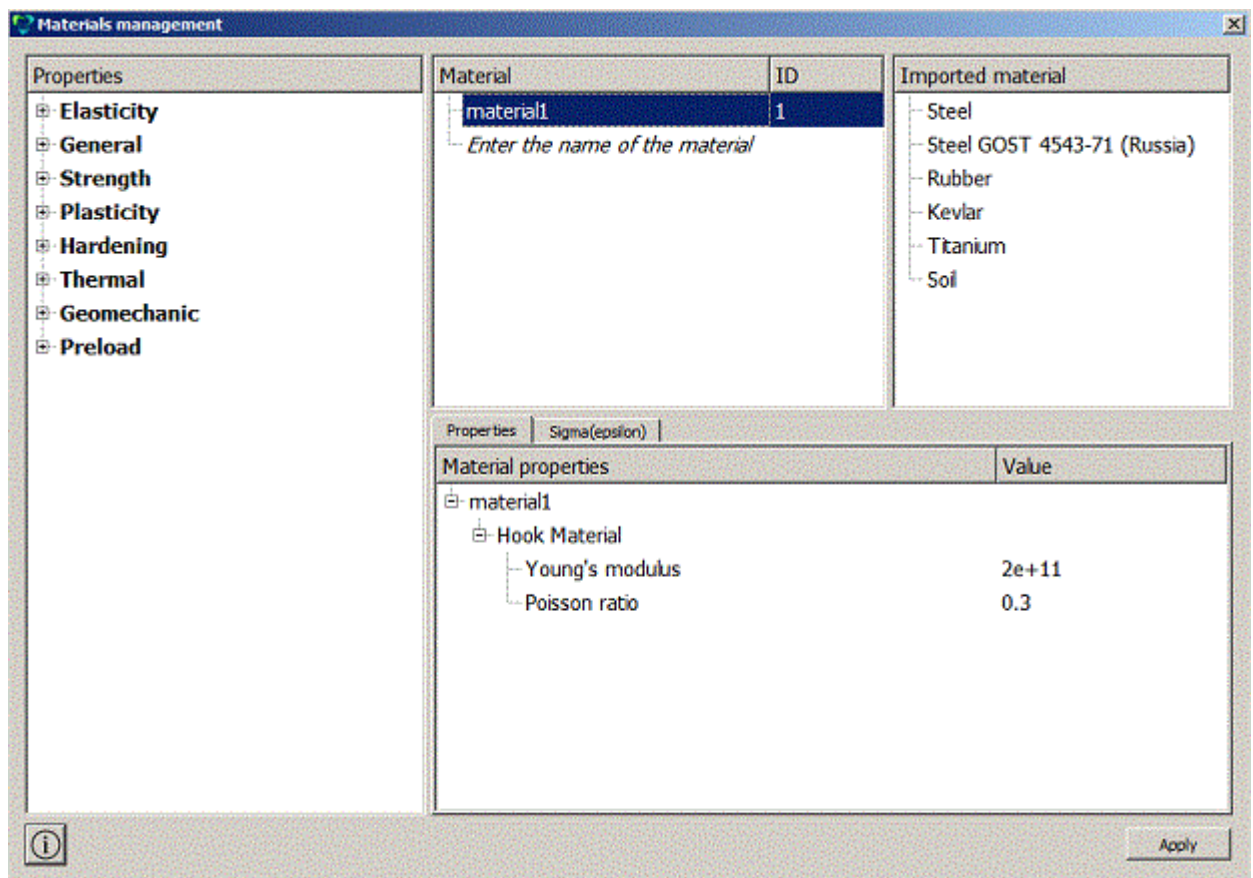

2. Create a block of the one type of material.

On the command panel, select (Mode - **Blocks**, Entity — **Block**, Action — **Add**).

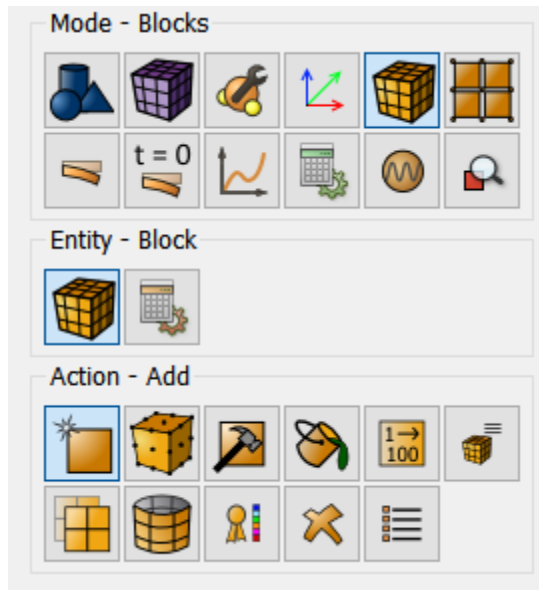

Set the following parameters:

- Block ID: 1;
- Entity list: Volume;
- Entity ID(s): All.

Click **Apply**.

3. Set the block parameters.

On the command panel, select the mode for setting material properties (Mode - **Blocks**, Entity - **Block**, Action - **Block properties/parameters**).

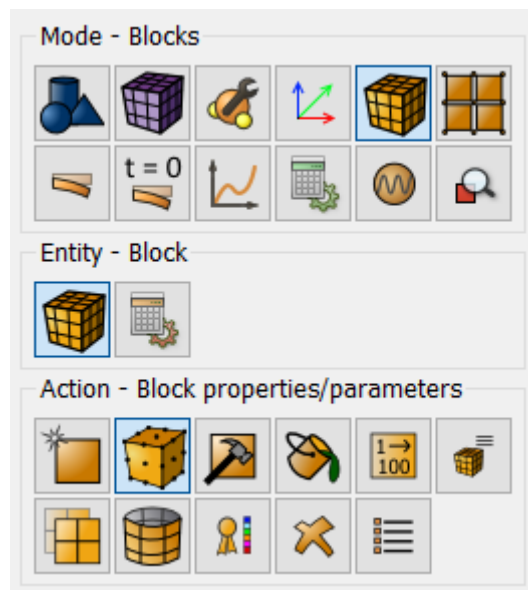

Set the following parameters:

- Block ID(s): 1;
- Available materials: material1;
- Coordinate System: Global Cartesian;
- Category: Solid;
- Order: 1.

Click **Apply**.

Setting boundary conditions

1. Fix the sides of the part with the condition of symmetry.

On the command panel, select (Mode - **Boundary Conditions**, Entity — **Displacement**, Action — **Create**).

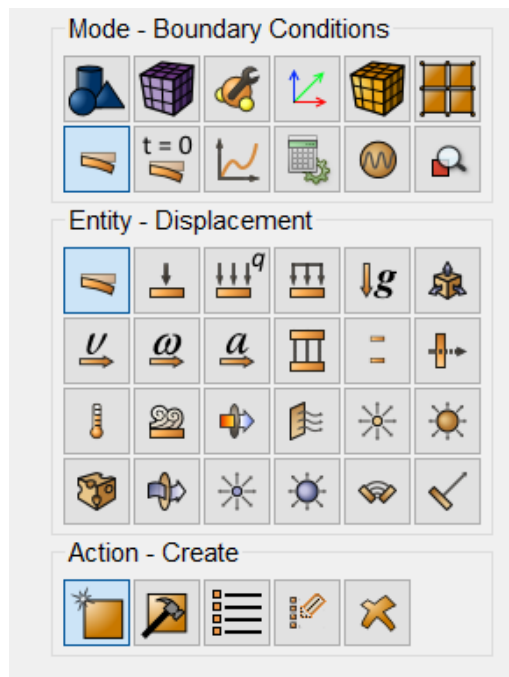

Set the following parameters:

- System assignment ID;
- Entity list: Surface;
- Entity ID(s): 2 27 38 (or select the vertices with the mouse while holding down the Ctrl key);
- Degrees of freedom: X-Translation Disp;
- DOF Value: 0 (can not fill).

Click **Apply**.

On the command panel, select (Mode - **Boundary Conditions**, Entity — **Displacement**, Action — **Create**).

Set the following parameters:

- System assignment ID;
- Entity list: Surface;
- Entity ID(s): 5 22 23 36 (or select the vertices with the mouse by pressing the Ctrl key);
- Degrees of freedom: Z-Translation Disp;
- DOF Value: 0 (can not fill).

Click **Apply**.

2. Fix the hole.

On the command panel, select (Mode - **Boundary Conditions**, Entity — **Displacement**, Action — **Create**).

Set the following parameters:

- System assignment ID;
- Entity list: Surface;
- Entity ID(s): 30 (or select the vertices with the mouse by pressing the Ctrl key);
- Degrees of freedom: All;
- DOF Value: 0 (can not fill).

Click **Apply**.

3. Apply pressure to the top face.

On the command panel, select (Mode - **Boundary Conditions**, Entity — **Pressure**, Action — **Create**).

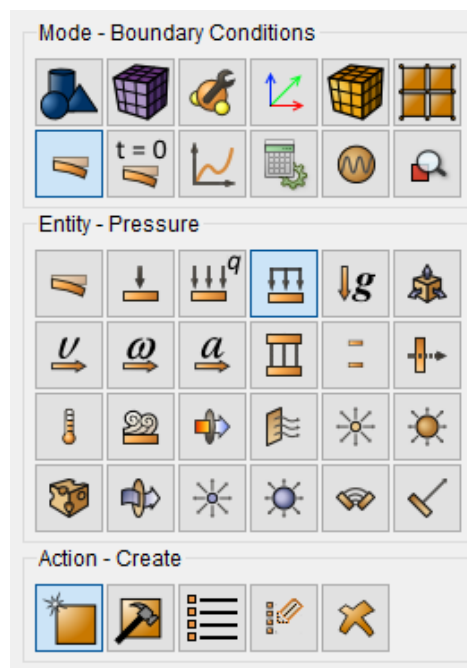

Set the following parameters:

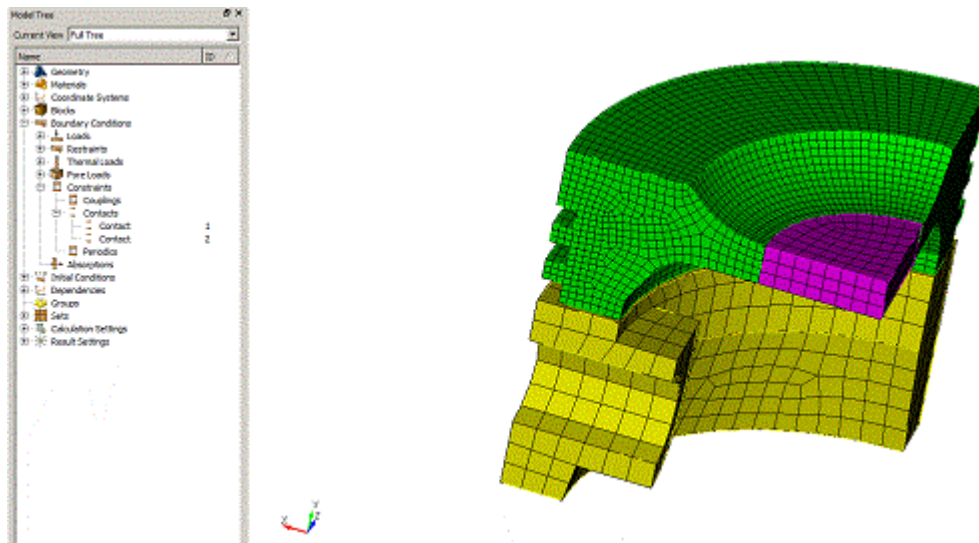

Starting calculation

1. Set the type of problem you want to solve.

On the command panel, select the calculation settings mode (Mode - **Calculation Settings**, Calculation Settings — **Static**, Static — **General**).

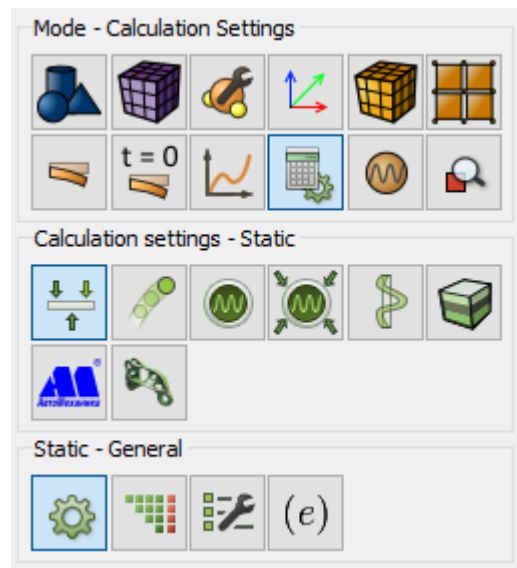

Set the following calculation parameters:

- Dimension: 3D;
- Model: Elasticity.

Click **Apply**.

2. In the window that appears, select the directory in which the result will be saved, and enter the file name.

3. In the case of a successful calculation, the console displays the message: *“Calculation finished successfully at <date> <time>”*.

Results analysis

1. Open the results file. There are three ways to do it:

- Click Ctrl+E.
- From the main menu, select **Results**. Click **Open last result**.
- Select **Results** on Command Panel (Mode - **Results**). Click **Open last result**.



The **Fidesys Viewer**, window will appear, in which you can view the calculation results.

2. Display the Contact Status Node for the model.

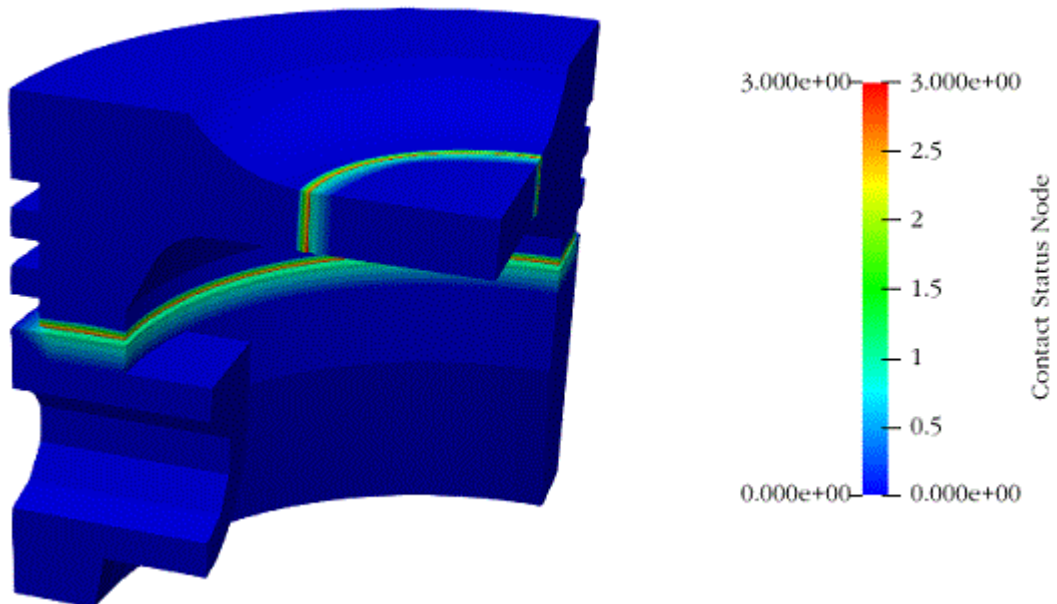
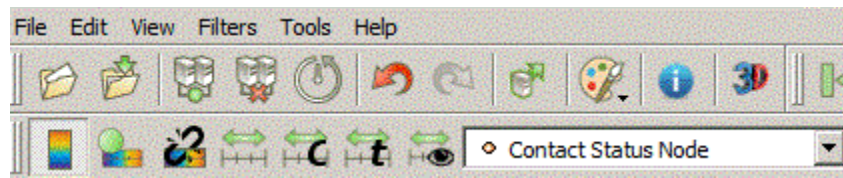

3. Display displacements for the deformed view of the model.

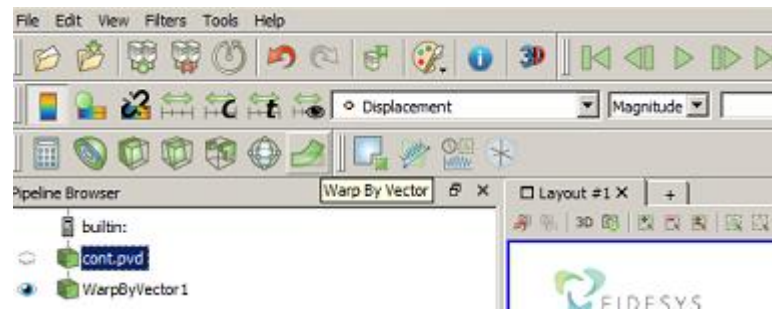

Specify the scale of 2000.

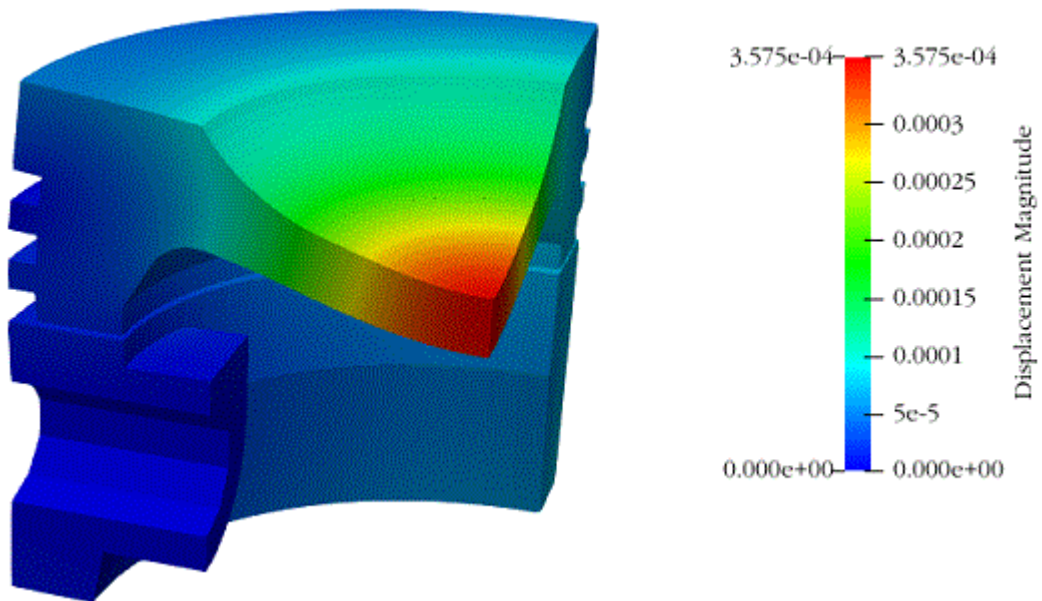

Using the console interface

For geometry generation, meshing, setting boundary conditions and materials you can use Console Interface.



It is also possible to run the file *modeling_contact.jou* by selecting Journal Editor on Toolbar. In a pop-up window of the main menu select **File** → **Open** and open the necessary journal file.

The loading history of the elastic-plastic plate

Hinton E. *Fundamental Tests for Two and Three-dimensional, Small Strain, Elastoplastic Finite Element Analysis* / Ernest Hinton, M.H. Ezatt. - NAFEMS, 1987.

We solve the problem of tension-compression of a square plate. Material parameters: $E = 250e3 \text{ N / mm}^2$, $\nu = 0.25$, yield strength $c = 5 \text{ N / mm}^2$. The model is meshed into one finite element. The left and bottom sides are fixed perpendicularly. The boundary conditions are presented in the figure below:

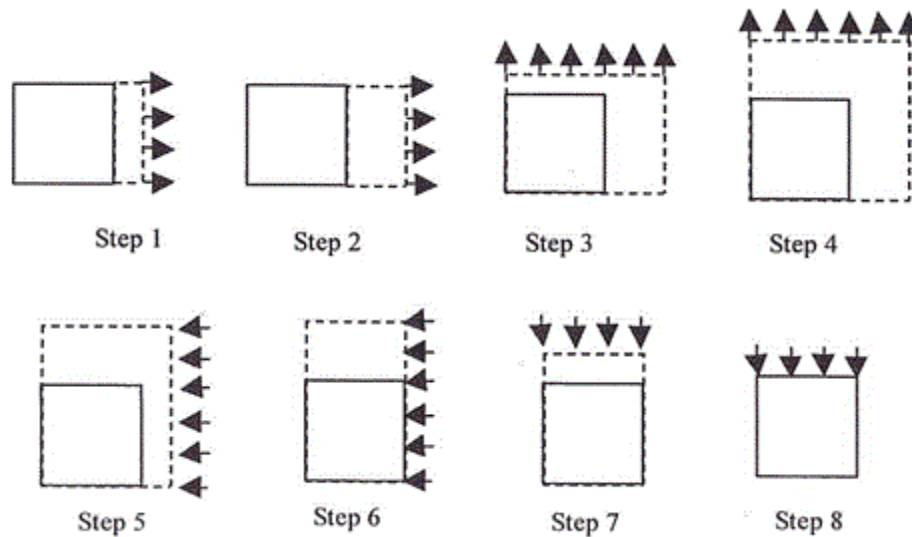

Geometry creating

1. Create a square plate.

On the command panel, select the mode for creating volume geometry (Mode - **Geometry**, Entity - **Surface**, Action - **Create**).



From the list of geometric primitives, select **Rectangle**. Set block sizes:

- Width: 1;
- Location: Zplane.

Click **Apply**.

2. Move the surface to the origin of CS.

On the command panel, select the mode for creating volume geometry (Mode - **Geometry**, Entity - **Surface**, Action - **Transform**).



From the list of possible transformations, select **Move**. Set the parameters:

- Surface ID(s): 1;
- Including Merged: uncheck;
- Select method: Distance;
- X Distance: 0.5;
- Y Distance: 0.5.

Click **Apply**.

Thus, the lower left corner of the plate has moved to the origin of CS.

Meshing

1. On the command panel, select the meshing mode on the curves (Mode - **Mesh**, Entity - **Curve**, Action - **Mesh**).

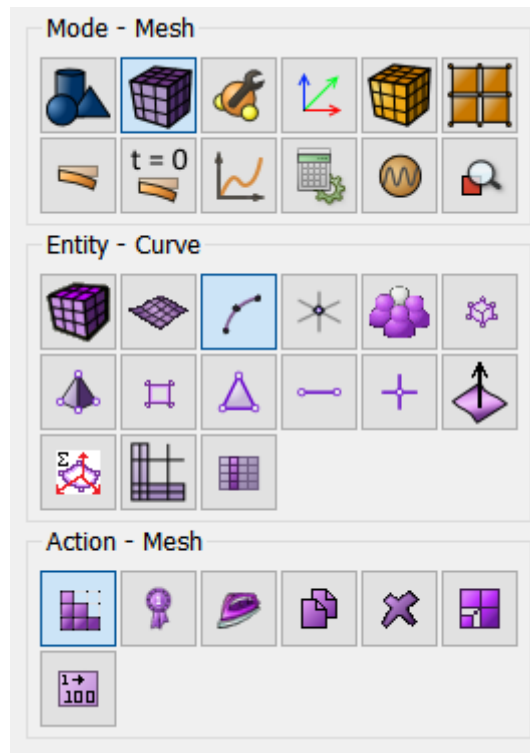

Specify the degree of refining mesh:

- Select Curves: all;
- Select the meshing method: Equal;
- Select the meshing options: Interval;
- Interval: 1.

Click **Apply Size**.

Click **Mesh**.

2. On the command panel, select the surface meshing mode (Mode - **Mesh**, Entity - **Surface**, Action - **Mesh**).

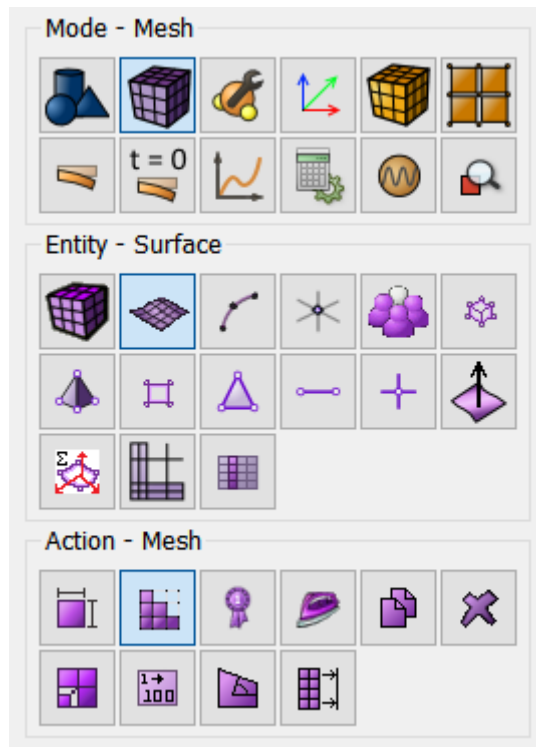

- Select the mesh scheme: Automatically Calculate;
- Select Surfaces: all.

Click **Apply Scheme**.

Click **Mesh**.

Specifying the material and block properties

1. Create material.

On the command panel, select the mode for setting material properties (Mode - **Material**, Entity - **Materials Management**).

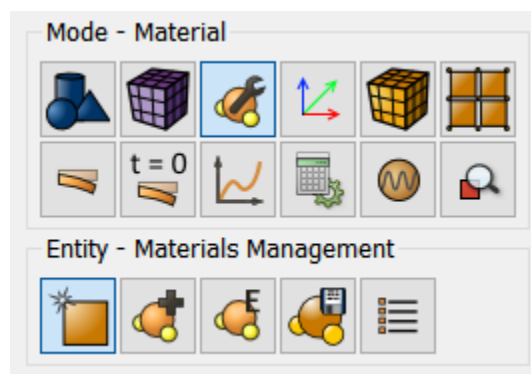

Specify the name of the material Material 1. Drag the Hook Material inscription from the left column into the Material Properties column. Set the following parameters:

- Young's modulus: 250e3;
- Poisson ratio: 0.25;

In the window on the left, go to the section Plasticity – Mises Criterion. Drag the Yield strength feature into the Material Properties window. Enter value:

- Yield strength: 5.

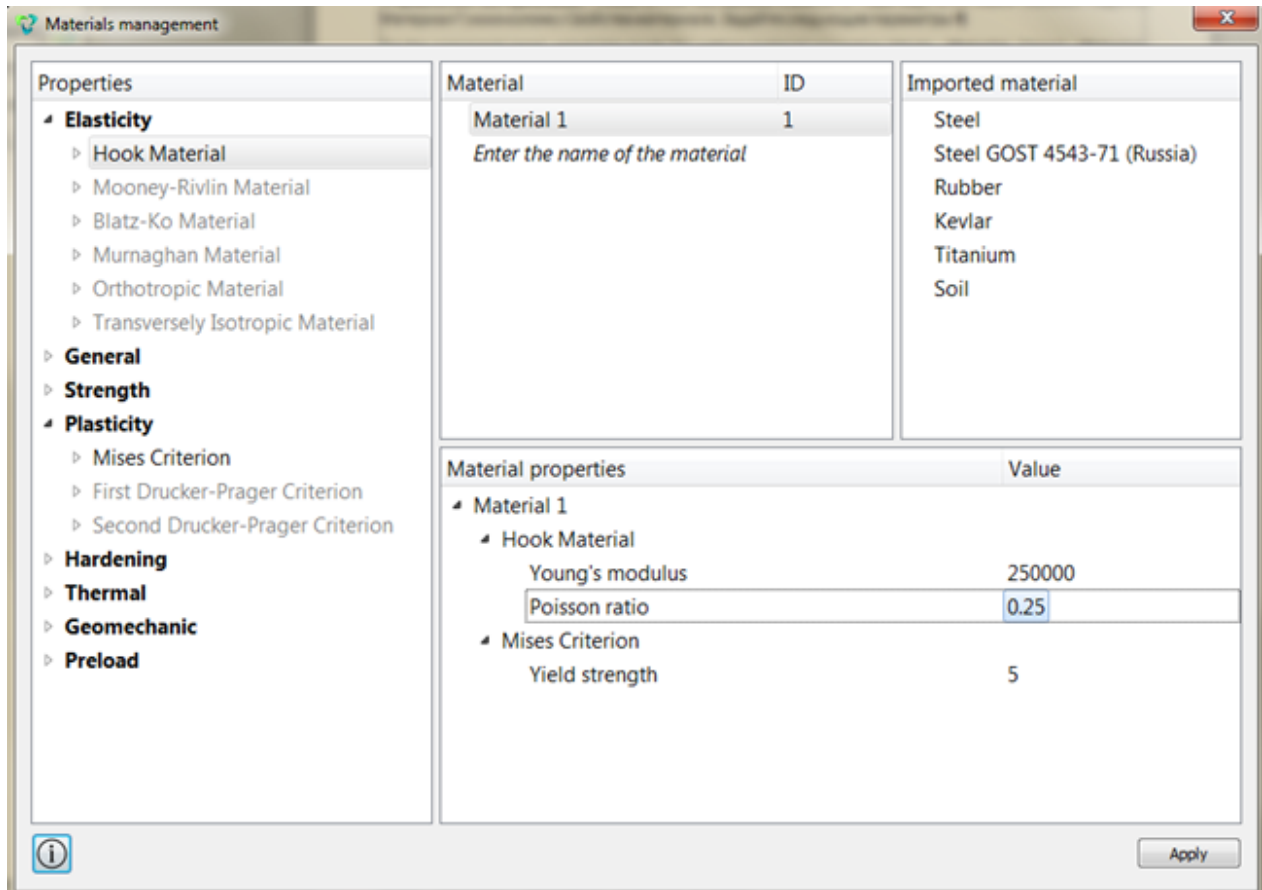

Click **Apply**.

2. Create a block of the one type of material.

On the command panel, select the mode for setting material properties (Mode - **Blocks**, Entity - **Block**, Action - **Add**).

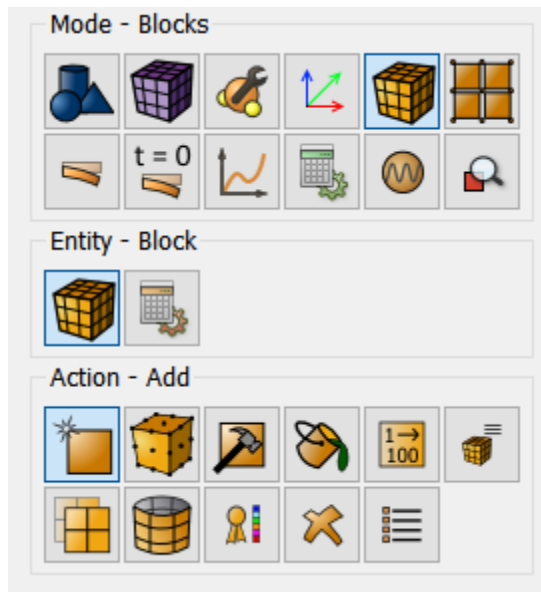

Set the following parameters:

- Block ID: 1;
- Entity list: Surface;
- Entity ID(s): 1 (or by command all).

Click **Apply**.

3. Set the block parameters.

On the command panel, select the mode for setting material properties (Mode - **Blocks**, Entity - **Block**, Action - **Block properties/parameters**).

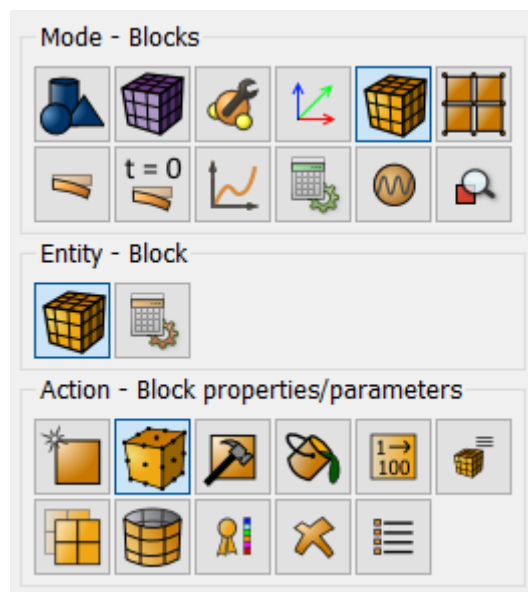

Set the following parameters:

- Block ID(s): 1;
- Available materials: Material 1;
- Coordinate System: Global Cartesian;
- Category: Plane;
- Order: 2.

Click **Apply**.

Setting boundary conditions

1. Fix curve 3 in the Y direction.

On the command panel, select (Mode - **Boundary Conditions**, Entity - **Displacement**, Action - **Create**).

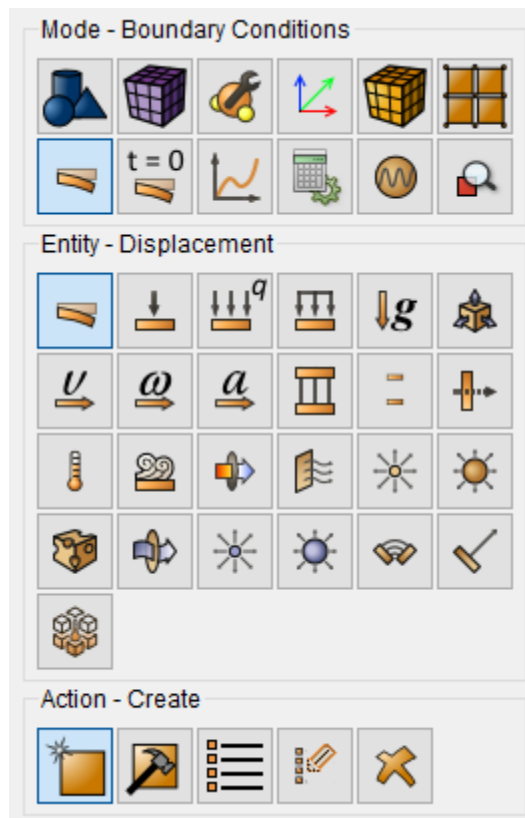

Set the following parameters:

- System assigned ID;
- Entity list: Curve;
- Entity ID(s): 3;
- Degrees of freedom: Y-Translation Disp;
- DOF Value: 0.

Click **Apply**.

2. Fix curve 2 in the X direction.

On the command panel, select (Mode - **Boundary Conditions**, Entity - **Displacement**, Action - **Create**).

Set the following parameters:

- System assigned ID;
- Entity list: Curve;
- Entity ID(s): 2;
- Degrees of freedom: X-Translation Disp;
- DOF Value: 0.

Click **Apply**.

3. Fix curve 4 in the X direction.

On the command panel, select (Mode - **Boundary Conditions**, Entity - **Displacement**, Action - **Create**).

Set the following parameters:

- System assigned ID;
- Entity list: Curve;
- Entity ID(s): 4;
- Degrees of freedom: X-Translation Disp;
- DOF Value: 0.

Click **Apply**.

4. Fix curve 1 in the Y direction.

On the command panel, select (Mode - **Boundary Conditions**, Entity - **Displacement**, Action - **Create**).

Set the following parameters:

- System assigned ID;
- Entity list: Curve;
- Entity ID(s): 1;
- Degrees of freedom: Y-Translation Disp;
- DOF Value: 0.

Click **Apply**.

Set the dependence of the BC on the time and / or coordinates

1. Set the dependence of the BC on the time and / or coordinates.

On the command panel, select Mode – **BC Dependency**.

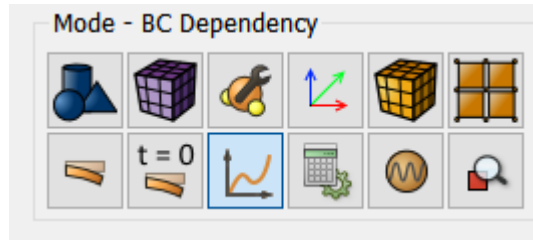

Click **Displacement 3** and choose panel Table in the right side. Set the flag: Time and fill in the table as follows:

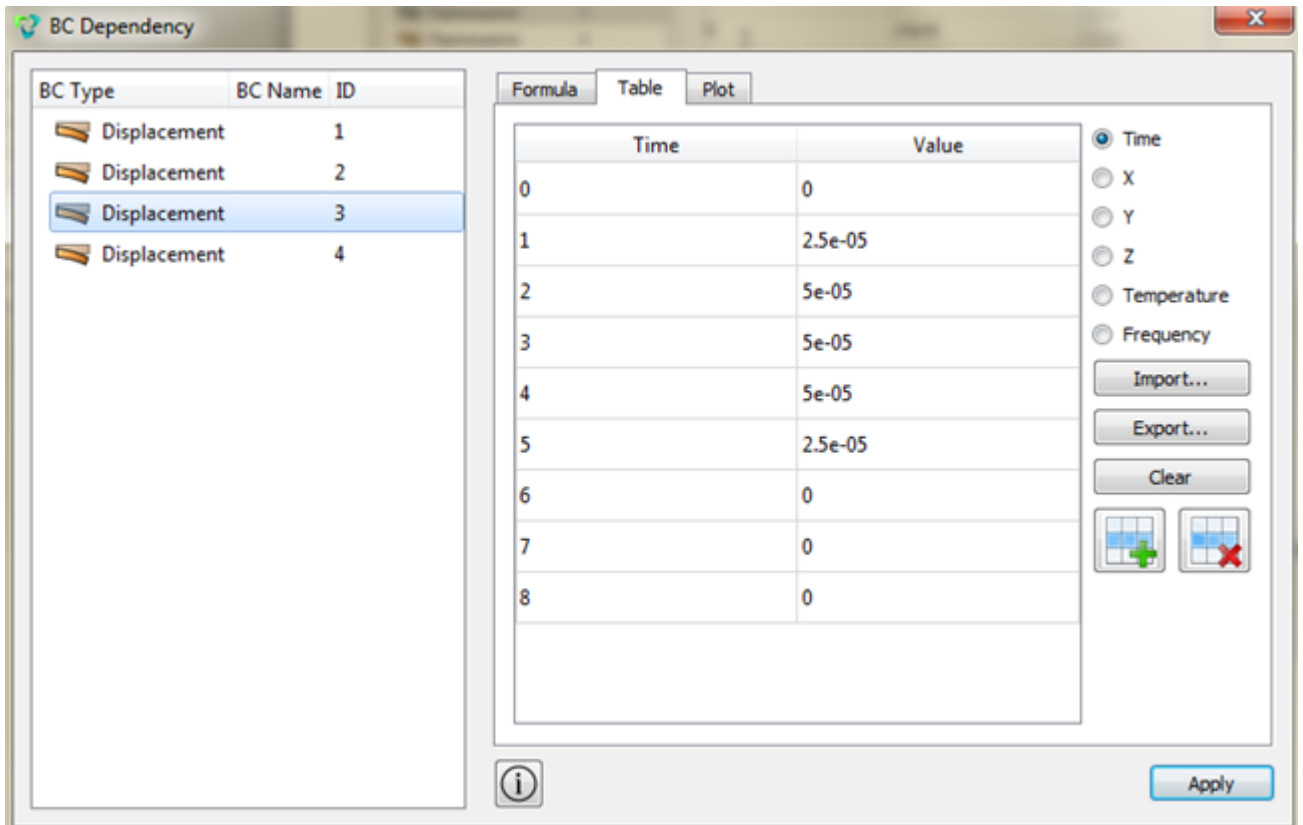

Click **Apply**.

2. Create table 2 for displacement

Click **Displacement 4** and choose panel Table in the right side. Set the flag: Time and fill in the table as follows:

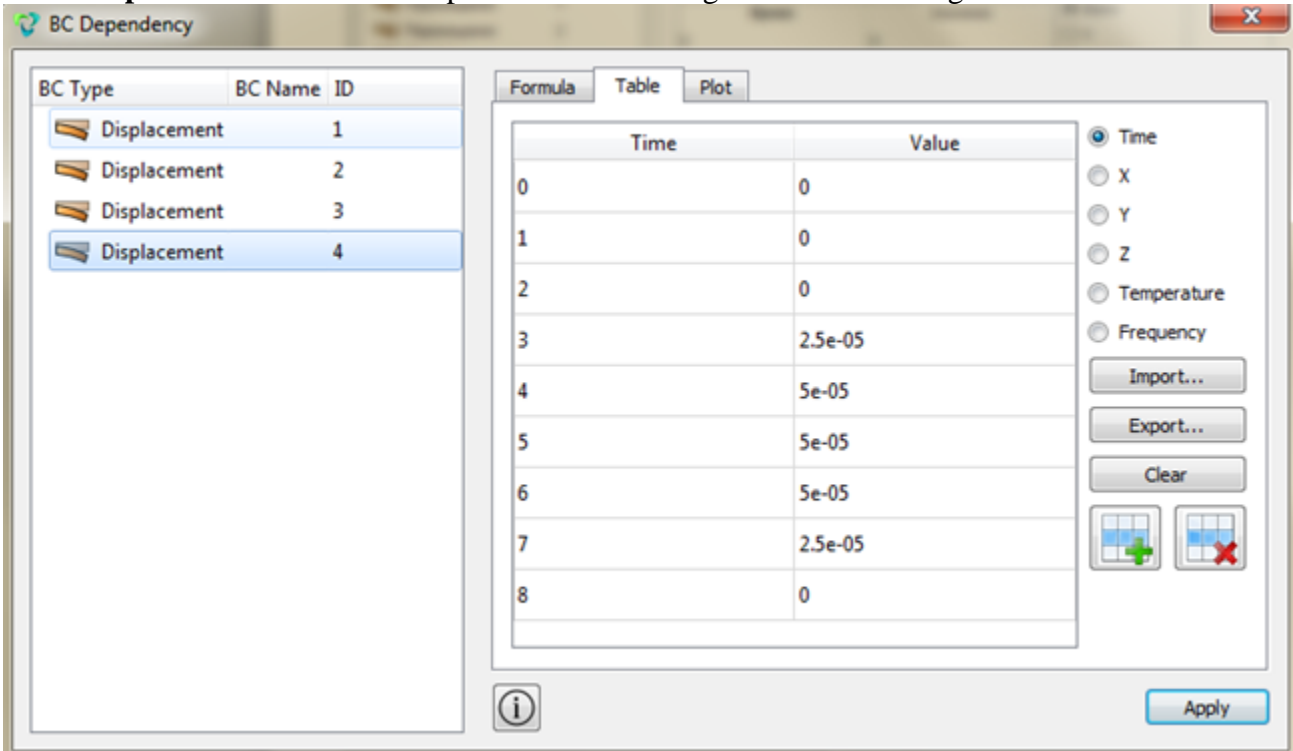

Click **Apply**.

Starting calculation

1. Set the type of problem you want to solve.

On the command panel, select the calculation settings module (Mode - **Calculation Settings**, Calculation Settings - **Static**, Static - **General**).

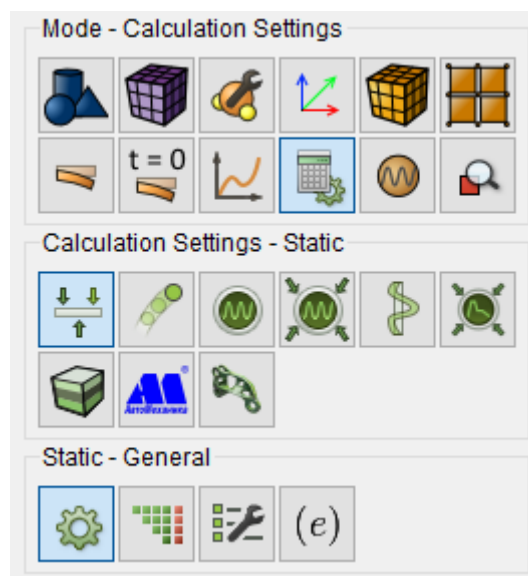

- Dimensions: 2D;
- Plain state: Plane strain;
- Model: Elasticity, Plasticity;
- Load steps count: 8.

Click **Apply**.

Click **Start Calculation**.

2. In the window that appears, select the directory in which the result will be saved, and enter the file name.

3. In the case of a successful calculation, the console displays the message: “Calculation finished successfully at "date time"”.

Results analysis

1. Open the file with the results. There are three ways to do that.

- Press Ctrl+E.
- From the main menu, select **Calculation** . Click **Open results**.
- Select **Results** on Command Panel (Mode - **Results**). Click **Open last result**.



To analyze the results, go to the *Fidesys Viewer* window.



To automatically apply changes to all filters, click the corresponding button **Apply changes to parameters automatically** on the command bar.

2. Connect the filter to **Warp by vector** (Menu - Filters - Alphabetical Index - Warp by vector). Or use the corresponding button on the command bar.



For this filter, on the Properties tab, set:

- Vector: Displacement;
- Scale multiplier: 10,000.

Click **Apply** (unless **Apply changes to parameters automatically** is enabled).

3. In the top pane, select the payroll result data to display. From the first drop-down list, select **Displacement**, from the second - **Magnitude**.



In the step view panel, set step 1.



You should see the plate image in the initial state. Next, click on Play. You should see a consistent stretching, and then compression of the plate in accordance with the loading history.

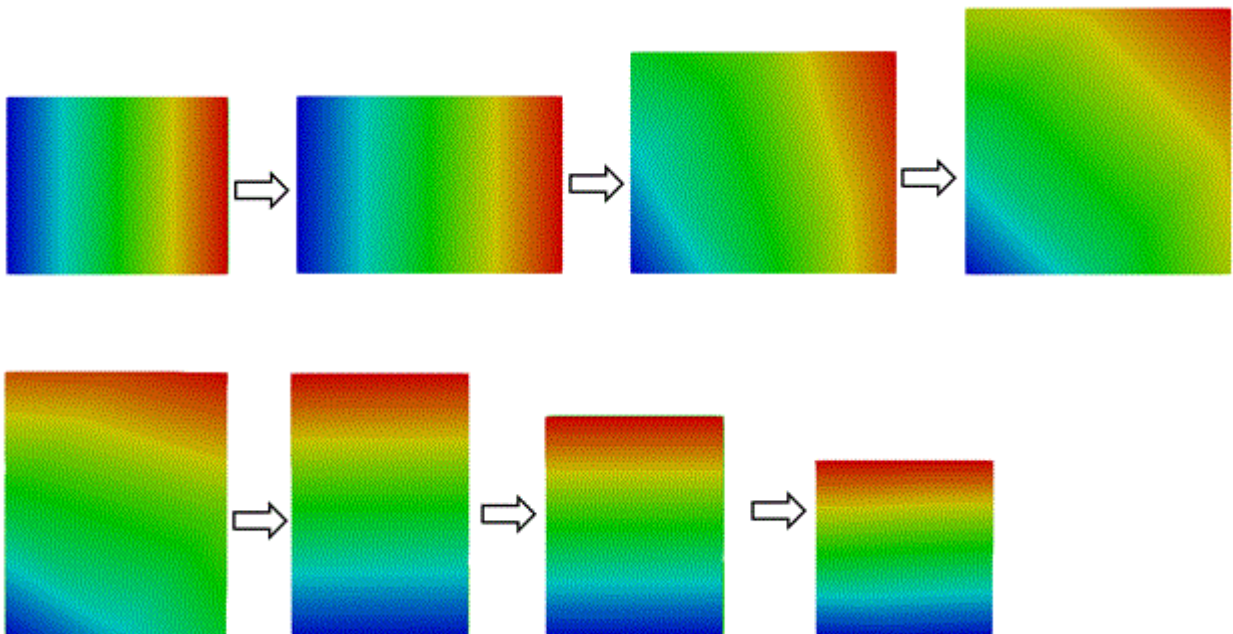

Thus, the calculation of the stress-strain state with the loading history of the plate was made.

Using the console interface

For geometry generation, meshing, setting boundary conditions and materials you can use Console Interface.



It is also possible to run the file *elastoplastic_plate_loadsteps.jou* by selecting Journal Editor on Toolbar. In a pop-up window of the main menu select **File** → **Open** and open the necessary journal file.

Click **Apply**.

3. Move the first brick to the origin of CS.

On the command panel, select the mode for creating volume geometry (Mode - **Geometry**, Entity - **Volume**, Action - **Transform**).

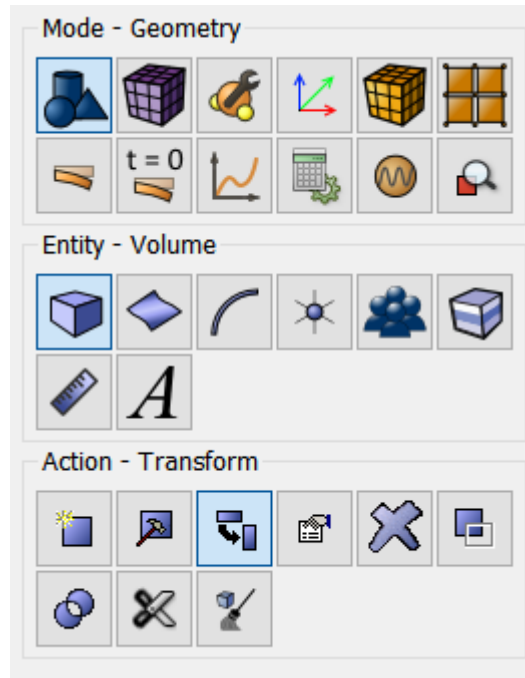

From the list of possible transformations, select **Move**. Set the parameters:

- Volume ID(s): 1;
- Including Merged: uncheck;
- Select Method: Distance;
- X Distance: 1;
- Y Distance: 0.5;
- Z Distance: 0.15.

Click **Apply**.

4. Move the second brick to the origin of CS.

On the command panel, select the mode for creating volume geometry (Mode - **Geometry**, Entity - **Volume**, Action - **Transform**).

From the list of possible transformations, select **Move**. Set the parameters:

- Volume ID(s): 1;
- Including Merged: uncheck;
- Select Method: Distance;
- X Distance: 2.5;
- Y Distance: 0.5;

- Z Distance: 0.15.

Click **Apply**.

5. Merge two volumes.

On the command panel, select the mode for creating volume geometry (Mode - **Geometry**, Entity - **Volume**, Action - **Imprint and Merge**).

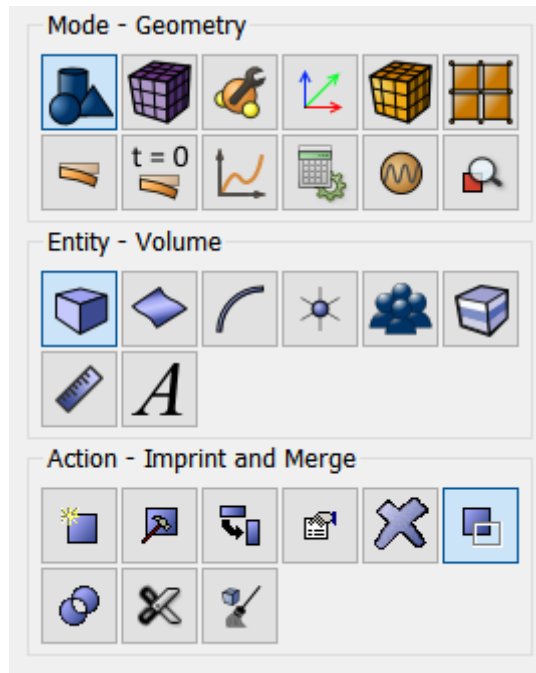

From the list of possible transformations, select **Merge Volumes**.

In the **Volume ID(s)** field, enter: all.

Click **Apply**.

Meshing

1. On the command panel, select the volume meshing mode (Mode - **Mesh**, Entity - **Volume**, Action - **Intervals**).

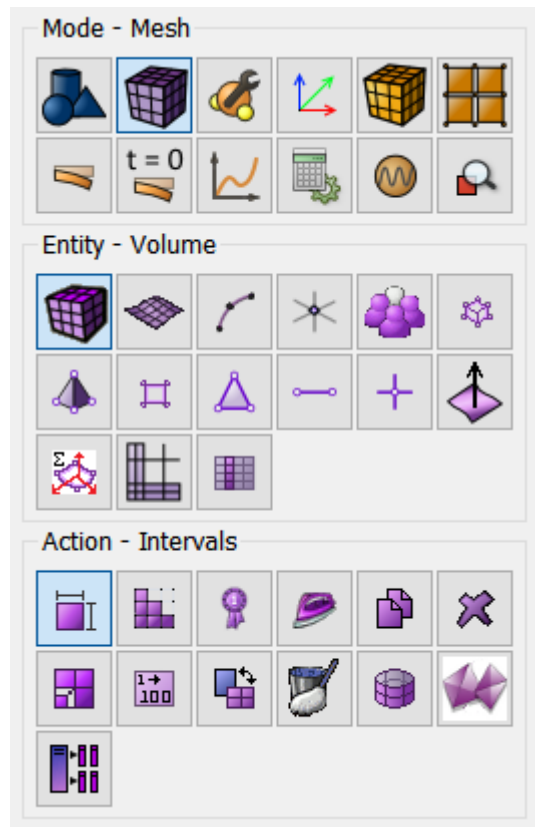

Specify the degree of refining mesh:

- Approximate Size: 0.1;
- Select Volumes: all.

Click **Apply Size**.

Click **Mesh**.

Specifying the material and block properties

1. On the command panel, select the mode for setting material properties (Mode - **Material**, Entity - **Materials Management**).

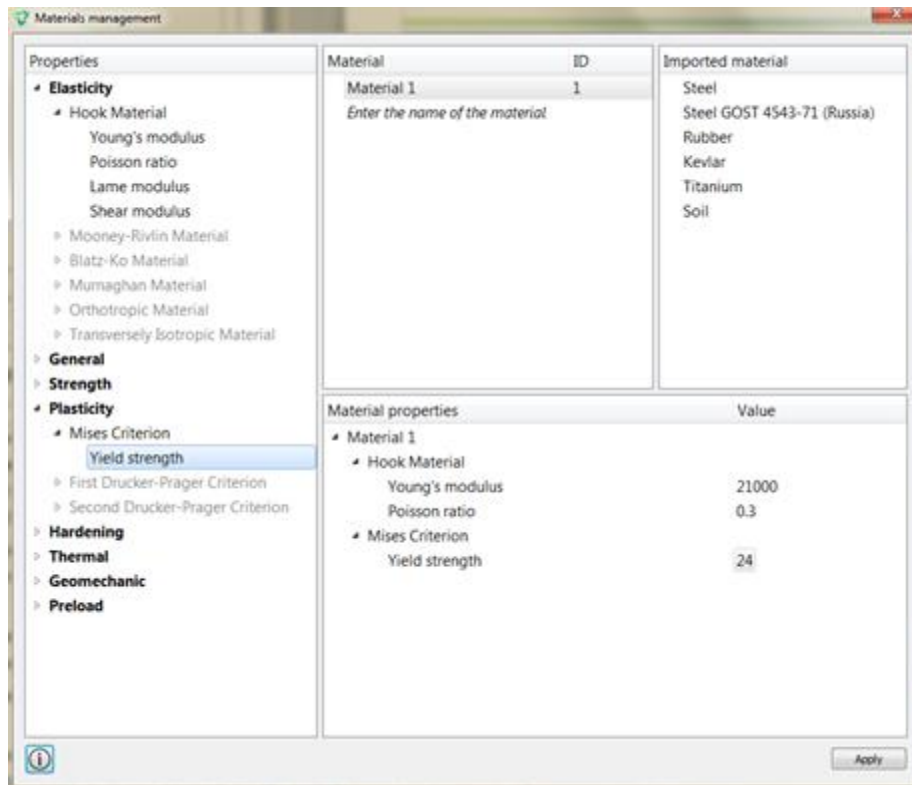

Specify the name of the material Material 1. Drag the Hook Material inscription from the left column into the Material Properties column. Set the following parameters:

- Young's modulus: 2.1e4;
- Poisson's ratio: 0.3.

In the left window, go to Plasticity - Mises Criterion and drag the Yield Strength feature into the Material Properties window. Set:

- Yield Strength: 24.

Click **Apply**.

2. Create a block.

On the command panel, select the mode for setting material properties (Mode - **Blocks**, Entity - **Block**, Action - **Add**).

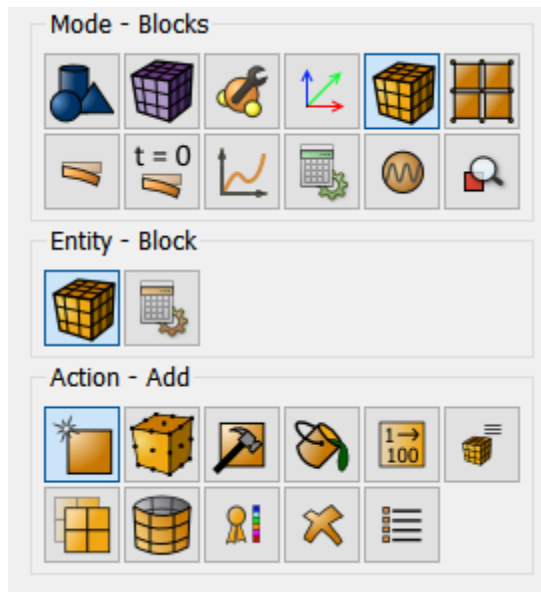

Set the following parameters:

- Block ID: 1;
- Entity List: Volume;
- Entity ID(s): 1 2 (or the all command).

Click **Apply**.

3. Set the block parameters.

On the command panel, select the mode for setting material properties (Mode - **Blocks**, Entity - **Block**, Action - **Block properties/parameters**).

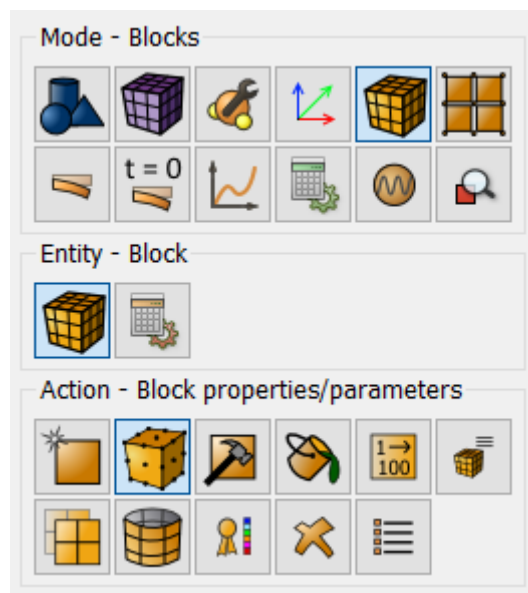

Set the following parameters:

- Block ID(s): 1;

- Material: Material 1;
- Coordinate System: Global Cartesian;
- Category: Solid;
- Order: 2.

Click **Apply**.

Setting boundary conditions

1. Fix the model along the Y axis.

On the command panel, select (Mode - **Boundary Conditions**, Entity - **Displacement**, Action - **Create**).

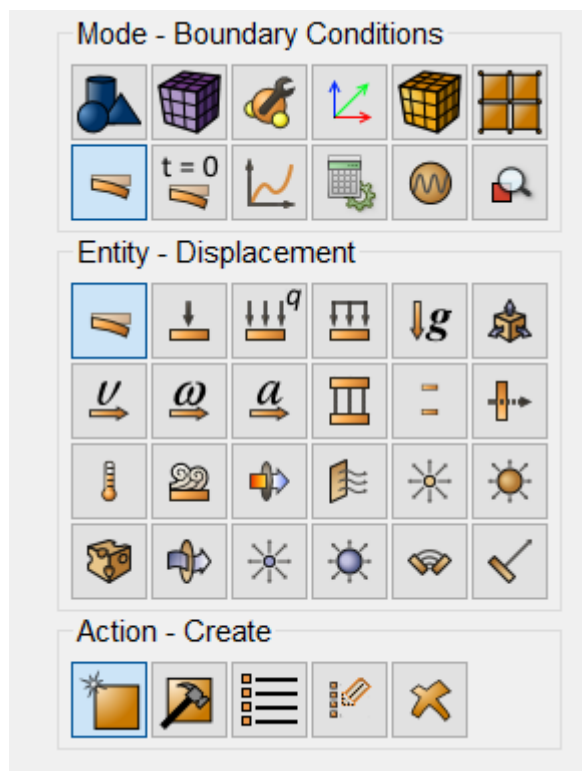

Set the following parameters:

- System Assigned ID;
- Entity List: Surface;
- Entity ID(s): 3 5 9 11;
- Degrees of Freedom: Y-Translation Disp;
- DOF Value: 0.

Click **Apply**.

2. Fix the model along the X axis.

On the command panel, select (Mode - **Boundary Conditions**, Entity - **Displacement**, Action - **Create**).

Set the following parameters:

- System Assigned ID;
- Entity List: Surface;
- Entity ID(s): 6;
- Degrees of Freedom: X-Translation Disp;
- DOF Value: 0.

Click **Apply**.

3. Fix the model along the X axis.

On the command panel, select (Mode - **Boundary Conditions**, Entity - **Displacement**, Action - **Create**).

Set the following parameters:

- System Assigned ID;
- Entity List: Surface;
- Entity ID(s): 12;
- Degrees of Freedom: X-Translation Disp;
- DOF Value: 0.

Click **Apply**.

4. Fix the model along the Z axis.

On the command panel, select (Mode - **Boundary Conditions**, Entity - **Displacement**, Action - **Create**).

Set the following parameters:

- System Assigned ID;
- Entity List: Surface;
- Entity ID(s): 1 2 7 8;
- Degrees of Freedom: Z-Translation Disp;
- DOF Value: 0.

Click **Apply**.

5. Apply pressure 100 MPa to the left side.

On the command panel, select (Mode - **Boundary Conditions**, Entity - **Pressure**, Action - **Create**).

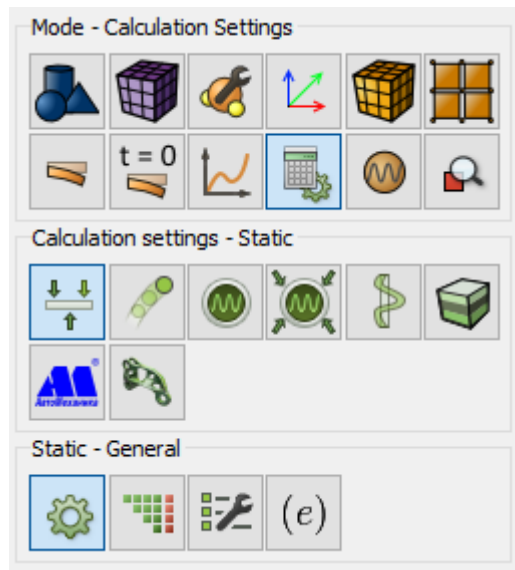

- Dimensions: 3D;
- Model: Elasticity, Plasticity;
- Load steps count: 2.

Click **Apply**.

2. Go to the Settings window load steps.

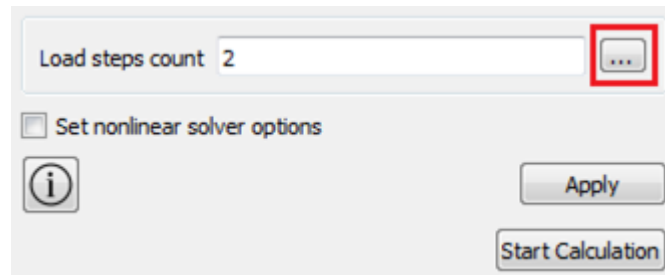

Set step calculation – 1 for displacement 2. Boundary condition will be active in this step.

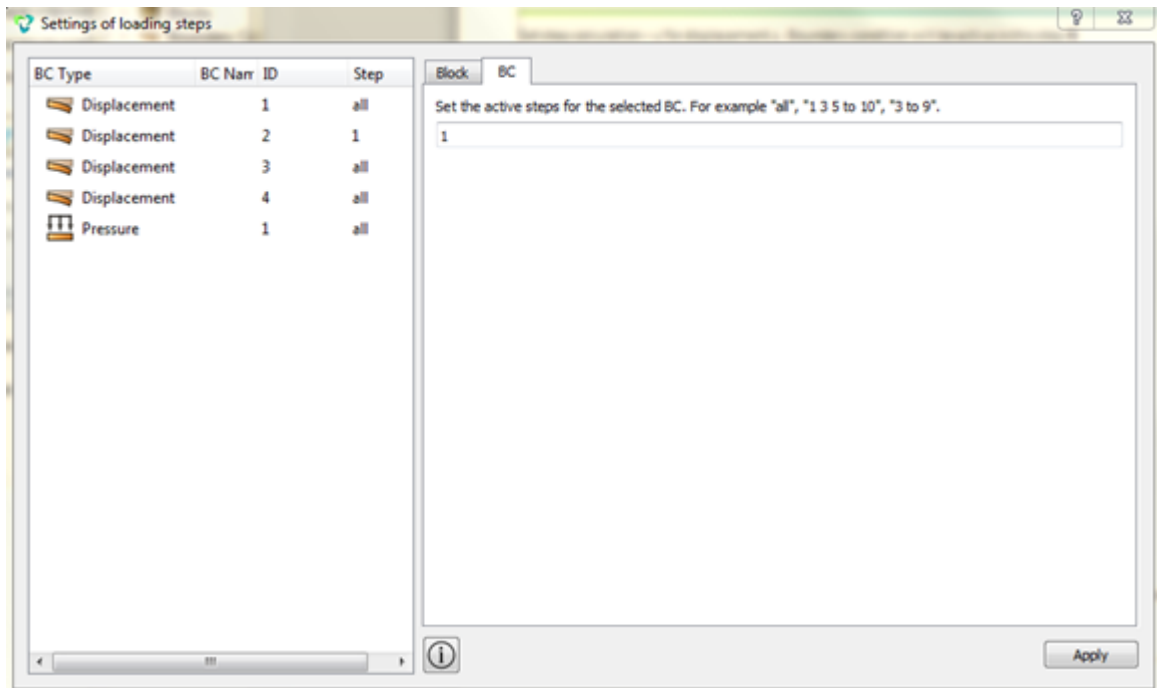

Click **Apply**.

3. In the setting load steps window, select block 2 and set at which calculation step this block will be active.

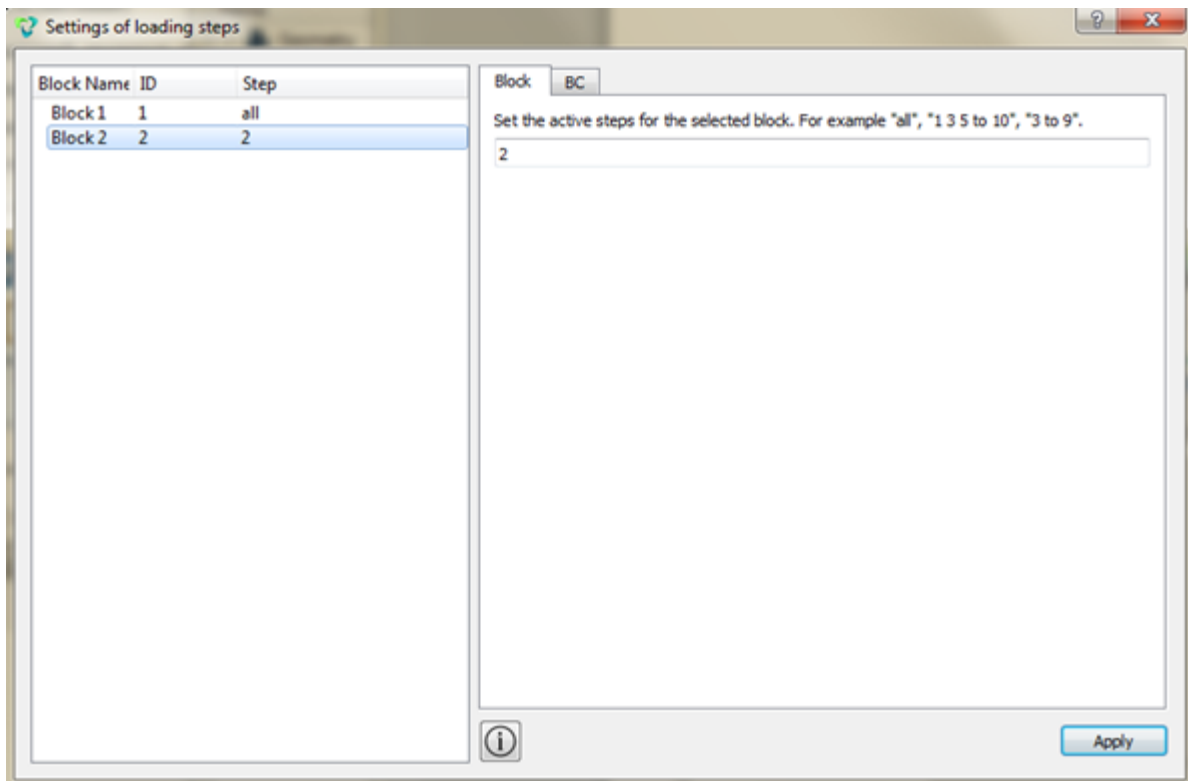

Click **Apply**.

Click **Start Calculation**.

4. In the window that appears, select the directory in which the result will be saved, and enter the file name.
5. In the case of a successful calculation, the console displays the message: Calculation finished successfully at "date time".

Result Analysis

1. Open the file with the results. There are three ways to do that.
 - Click Ctrl+E.
 - From the main menu, select **Calculation** . Click **Open results**.
 - Select **Results** on Command Panel (Mode - **Results**). Click **Open last result**.

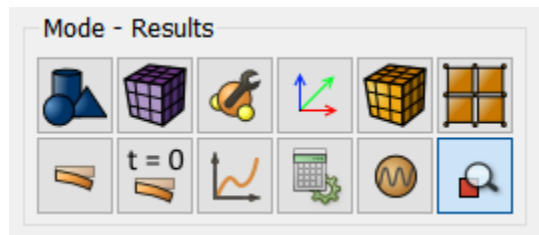

For postprocessor analysis, go to the *Fidesys Viewer* window.

2. Connect the filter **Warp by Vector** (**Menu - Filters – Alphabetical - Warp by Vector**). Or use the corresponding button on the command bar:



For this filter, on the Properties tab, set:

- Vector: Displacement;
- Scale factor: 100;

Click **Apply**.

3. On the top bar, select the required result data to display. From the first drop-down list, select **Displacement**, from the second - **Magnitude**, from the third - **Surface with edges**.



□ In the step view panel, set step 1. You should see the image in the initial state. Next, click on Play . You should see the sequential compression of the model in accordance with the loading history.

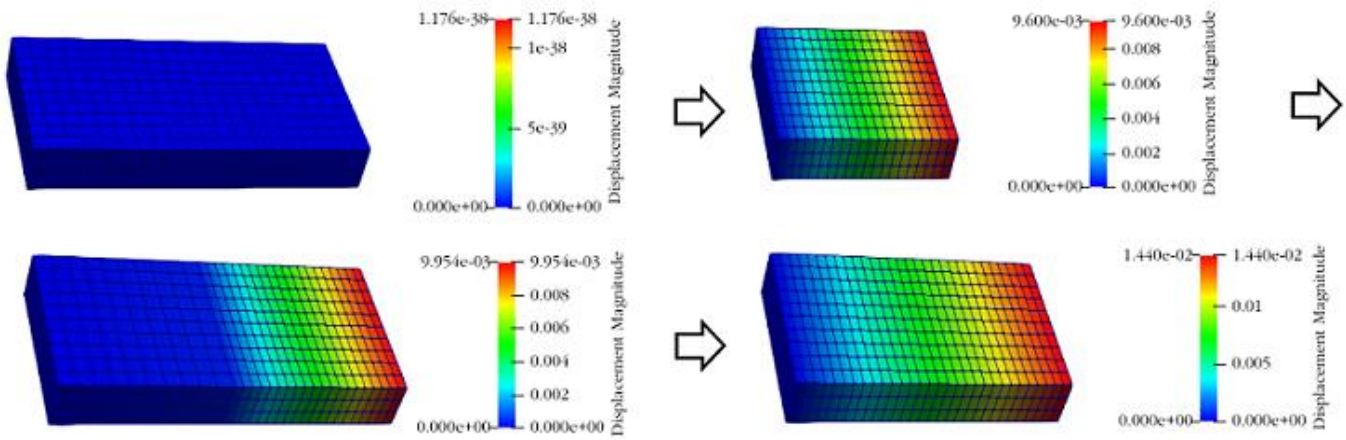

Using the console interface

For geometry generation, meshing, setting boundary conditions and materials you can use Console Interface.



It is also possible to run the `add_layers.jou` by selecting Journal Editor on Toolbar. In a pop-up window of the main menu select **File** → **Open** and open the necessary journal file.

Sequential Deletion of Volumes in The Calculation Process

The model is a cylindrical tube consisting of three layers. Material parameters for all three layers: $E = 2.1e4 \text{ N / mm}^2$, $\nu = 0.3$, yield strength $c = 24 \text{ N / m}^2$. A uniform pressure of 14 N / mm^2 is applied to the inner surface of the pipe. Fixation according with the symmetry condition. Three loading steps are specified: in the second step, the outer layer of the pipe is removed, in the third step, the next outer layer of the pipe is removed. In the process of solution, stresses are analyzed with the plastic flow and pipe thinning

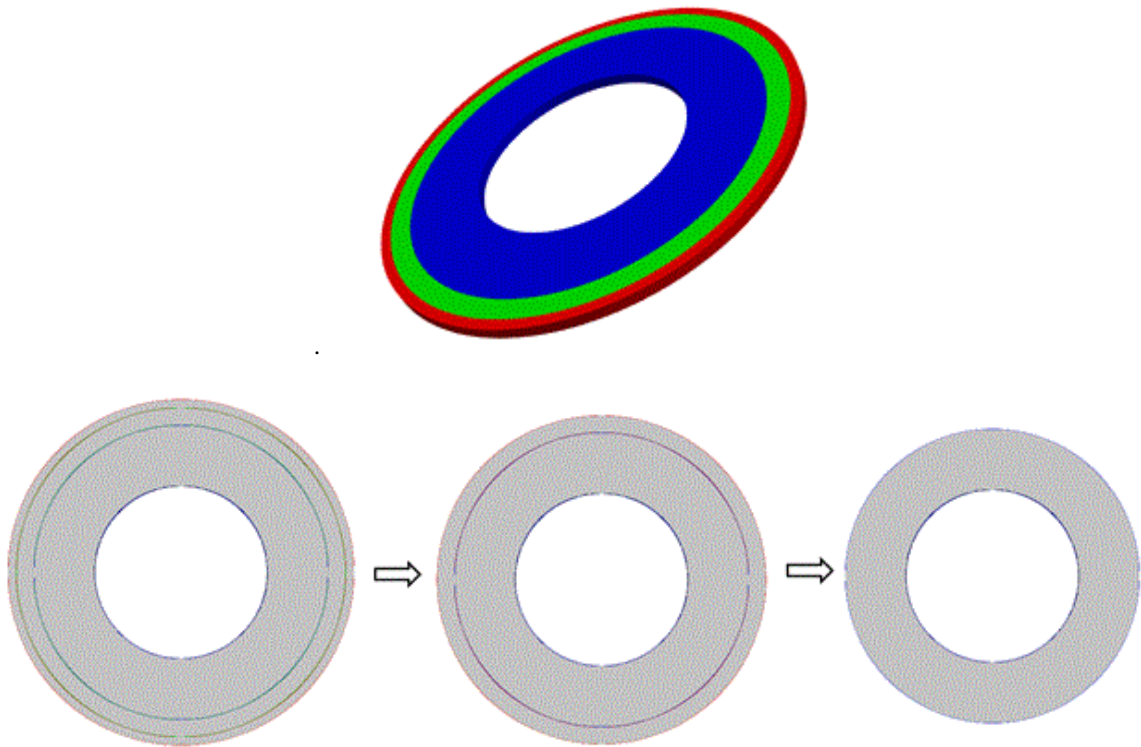

Geometry Creating

1. Create a circular surface with a radius of 100.

On the command panel, select the mode for creating volume geometry (Mode - **Geometry**, Entity - **Surface**, Action - **Create**).

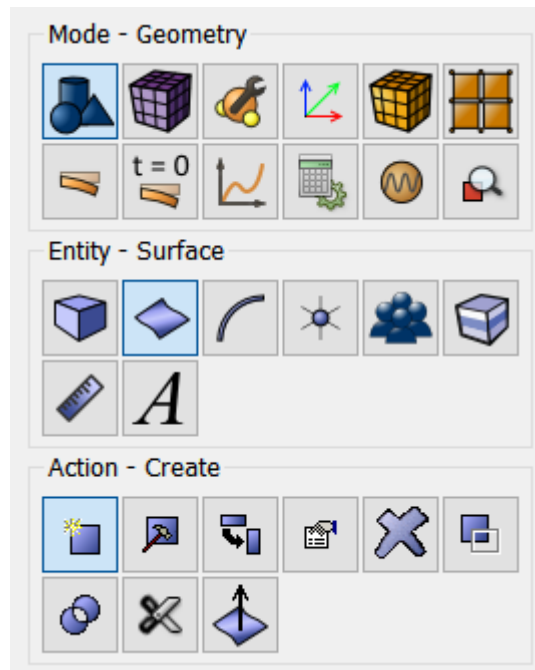

From the list of geometric primitives, select **Circle**. Set the dimensions:

- Radius: 100;
- Location: Z-plane.

Click **Apply**.

2. Create a circular surface with a radius of 170. Set the dimensions:

- Radius: 170;
- Location: Z-plane.

Click **Apply**.

3. Create a circular surface with a radius of 190. Set the dimensions:

- Radius: 190;
- Location: Z-plane.

Click **Apply**.

4. Create a circular surface with a radius of 200. Set the dimensions:

- Radius: 190;
- Location: Z-plane.

Click **Apply**.

5. Subtract surface 1 from the remaining surfaces 2 3 4.

On the command panel, select the mode for creating volume geometry (Mode - **Geometry**, Entity - **Surface**, Action - **Boolean**).

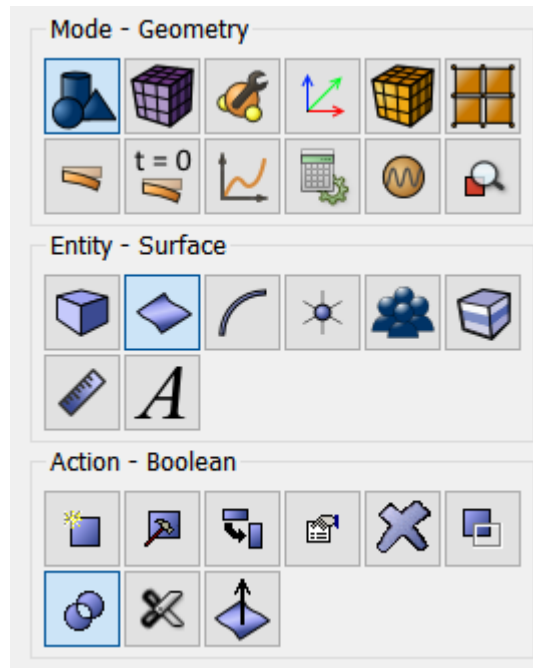

From the list of operations, select **Subtract**. Set the following parameters:

- Surface ID (s): 2 3 4 (surfaces from which other surface will be subtracted);
- Surface ID (s): 1 (surfaces to be subtracted).

Click **Apply**.

6. Subtract surface 5 from surface 6.

On the command panel, select the mode for creating volume geometry (Mode - **Geometry**, Entity - **Surface**, Action - **Boolean**).

From the list of operations, select **Subtract**. Set the following parameters:

- Surface ID (s): 6 (surfaces from which other surface will be subtracted);
- Surface ID (s): 5 (amounts to be deducted);
- Check the Keep Originals box and select Keep both (A and B).

Click **Apply**.

7. Subtract surface 6 from surface 7.

On the command panel, select the mode for creating volumetric geometry (Mode - **Geometry**, Entity - **Surface**, Action - **Boolean**).

From the list of operations, select **Subtract**. Set the following parameters:

- Surface ID (s): 6 (surfaces from which other surface will be subtracted);
- Surface ID (s): 7 (surfaces to be subtracted).

Click **Apply**.

8. Cut the body.

On the command panel, select the mode for creating volumetric geometry (Mode - **Geometry**, Entity - **Surface**, Action - **Webcut**).

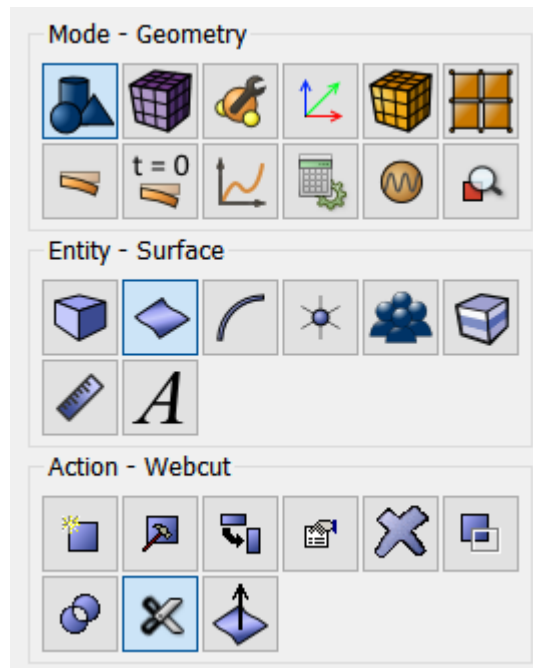

From the list of possible types of cuts, select **Coordinate Plane**. Set the following parameters:

- Body ID(s): all (the surfaces to be cut);
- Cut: Plane YZ;
- Offset value: 0.

Click **Apply**.

Do the same, but in the ZX plane:

On the command panel, select the mode for creating volumetric geometry (Mode - **Geometry**, Entity - **Surface**, Action - **Webcut**).

From the list of possible types of cuts, select **Coordinate Plane**. Set the following parameters:

- Body ID(s): all (the surfaces to be cut);
- Cut: Plane ZX;
- Offset value: 0.

Click **Apply**.

9. Delete the surface.

On the command panel, select the mode for constructing volumetric geometry (Mode - **Geometry**, Entity - **Surface**, Action - **Delete**).

- Perpendicular;
- Distance: 10.

Click **Apply**.

Meshing

1. On the command panel, select the mesh generation mode on curves (Mode - **Mesh**, Entity - **Curve**, Action - **Mesh**).

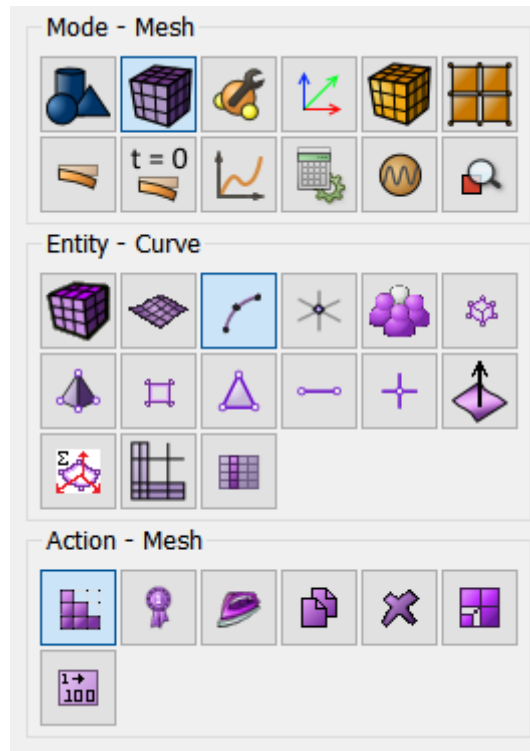

Specify the degree of refining mesh:

- Curve selection: 71 76 79 87 (through spaces);
- Select the mesh generation method: Equal;
- Select the partitioning options: Interval;
- Interval: 50 (see picture).

Click **Apply**.

2. On the command panel, select the mesh generation module on curves (Mode - **Mesh**, Entity - **Curve**, Action - **Mesh**).

Specify the degree of refining mesh:

- Select Curves: 74 82 90 78 86 94 (through spaces);
- Select the meshing method: Equal;
- Select the partitioning options: Approximate size;
- Approximate size: 2.

Click **Apply**.

3. On the command panel, select the mesh generation module on curves (Mode - **Mesh**, Entity - **Curve**, Action - **Mesh**).

Specify the degree of refining mesh:

- Select Curves: 75 72 80 88 77 73 81 89 (through spaces);
- Select the meshing method: Evenly;
- Select the partitioning options: Interval;
- Interval: 1 (see picture).

Click **Apply**.

4. On the command panel, select the mesh generation module on the planes (Mode - **Mesh**, Entity - **Volume**, Action - **Intervals**).

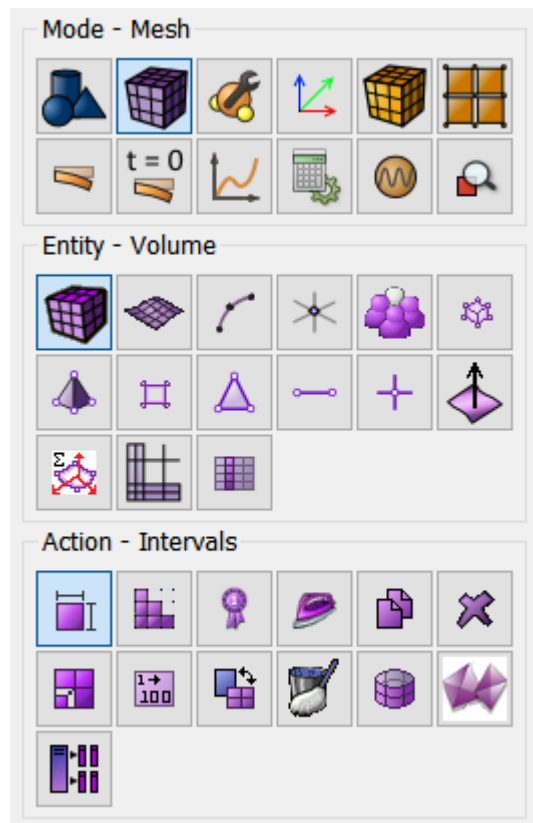

Specify the mesh spacing:

- Select Volumes: all;
- Select the meshing mode: Automatic Sizing.

Click **Apply Size**.

Click **Mesh**.

Set the Material

1. On the command panel, select the module for setting material properties (Mode - **Material**, Entity - **Materials Management**).

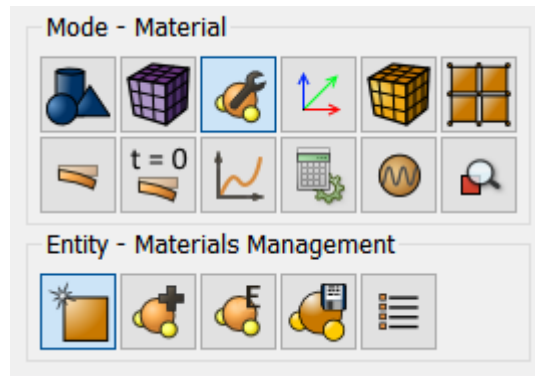

Specify the name of the material Material 1.

2. Drag the Hook Material inscription from the left column, as well as, under the Mises inscription, in the Plasticity section, in the Material Properties column. Set the following parameters:

- Young's modulus: $2.1e + 04$;
- Poisson's ratio: 0.3.

In the left window, go to Plasticity - According to Mises and drag the Yield Strength feature into the Material Properties window. Set:

- Yield strength: 24.

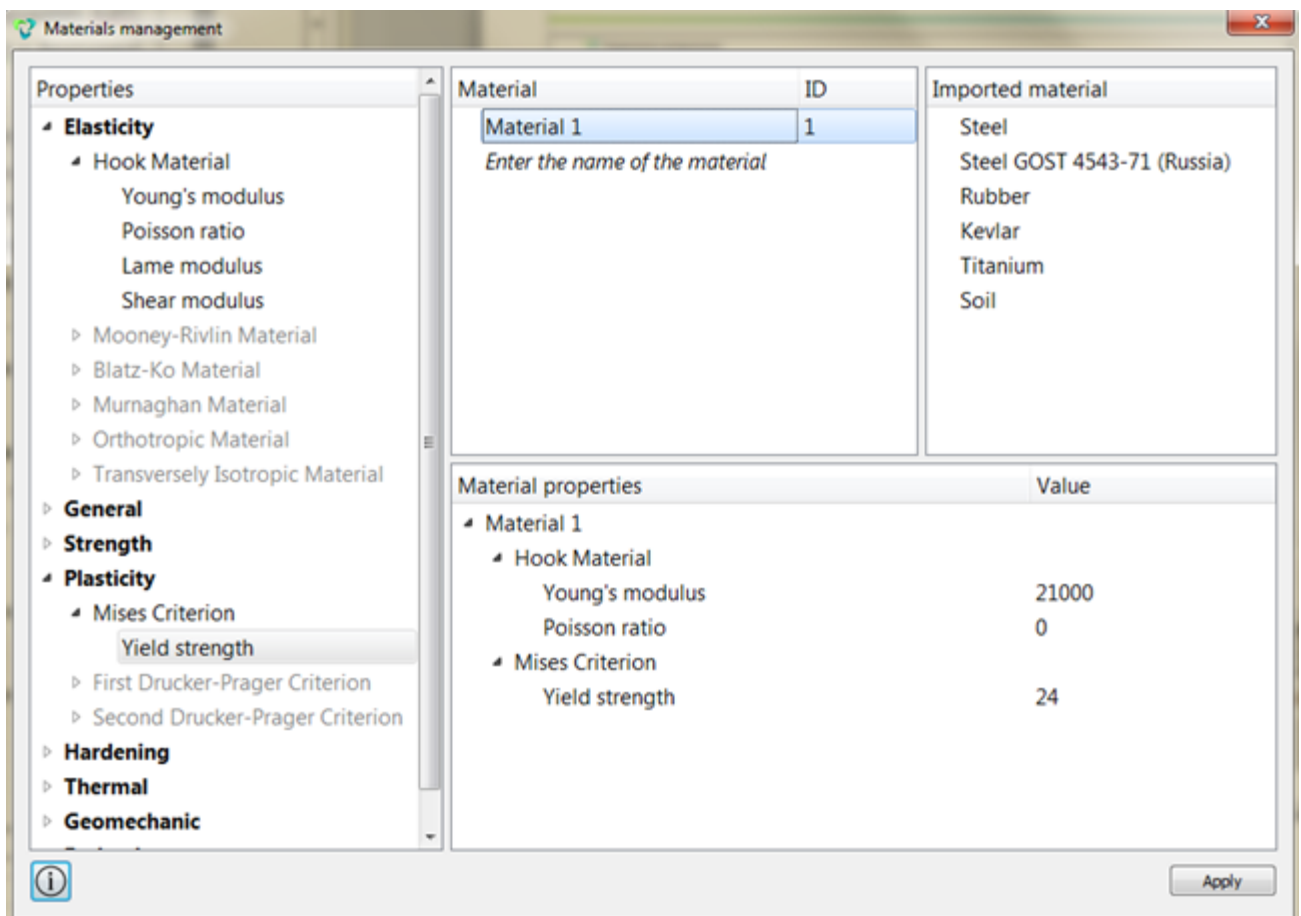

Click **Apply**.

Setting boundary conditions

1. On the command panel, select (Mode - **Boundary Conditions**, Entity - **Displacement**, Action - **Create**).

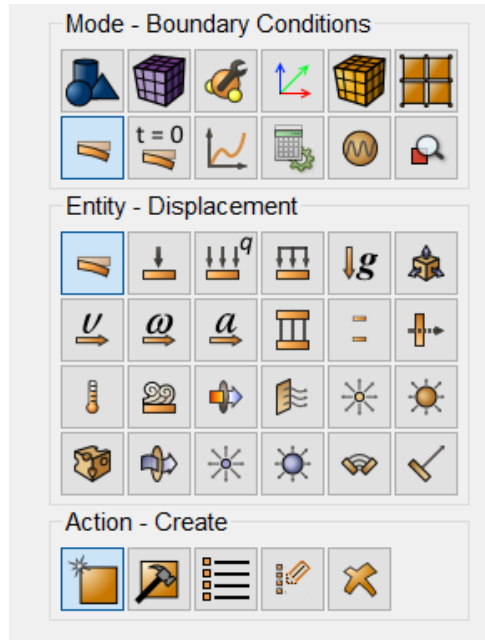

Set the following parameters:

- System Assigned ID;
- Entity List: Surface;
- Entity ID(s): 29 34 39;
- Degrees of Freedom: Y-Translation Disp;
- DOF Value: 0.

Click **Apply**.

2. On the command panel, select (Mode - **Boundary Conditions**, Entity - **Displacement**, Action - **Create**).

Set the following parameters:

- System Assigned ID;
- Entity List: Surface;
- Entity ID(s): 31 26 41;
- Degrees of Freedom: X-Translation Disp;
- DOF Value: 0.

Click **Apply**.

3. On the command panel, select (Mode - **Boundary Conditions**, Entity - **Displacement**, Action - **Create**).

Set the following parameters:

- System Assigned ID;
- Entity List: Surface;
- Entity ID(s): 32 37 42 18 22 26;
- Degrees of Freedom: Z-Translation Disp;
- DOF Value: 0.

Click **Apply**.

4. Apply uniform pressure to the surface.

On the command panel, select (Mode - **Boundary Conditions**, Entity - **Pressure**, Action - **Create**).

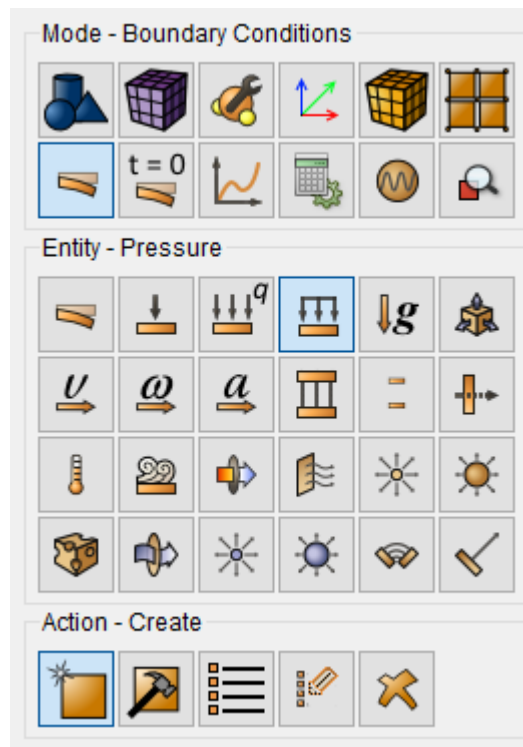

Set the following parameters:

- System Assigned ID;
- Pressure Entity List: Surface;
- Entity ID(s): 30;
- Magnitude Value: 14.

Click **Apply**.

Set the material and block properties

1. Create block of one type of material.

On the command panel, select the module for setting material properties (Mode - **Blocks**, Entity - **Block**, Action – **Add**).

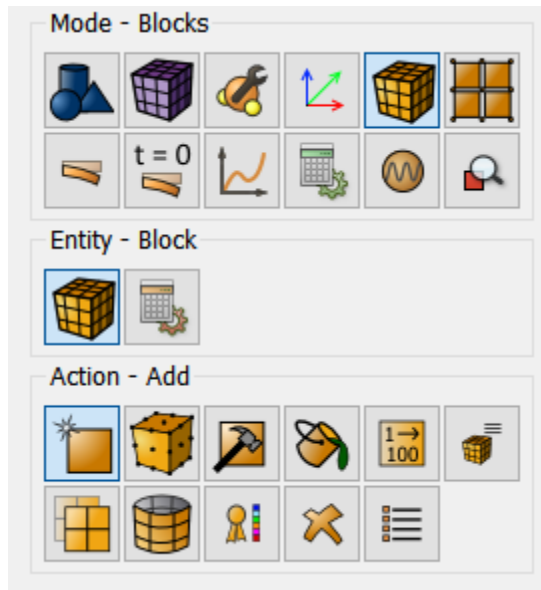

Set the following parameters:

- Block ID: 1;
- Entity List: Volume;
- Entity ID(s): 6.

Click **Apply**.

2. Create a second block.

On the command panel, select the module for setting material properties (Mode - **Blocks**, Entity - **Block**, Action – **Add**).

Set the following parameters:

- Block ID: 2;
- Entity List: Surface;
- Entity ID (s): 7.

Click **Apply**.

3. Create the third block.

On the command panel, select the module for setting material properties (Mode - **Blocks**, Entity - **Block**, Action – **Add**).

Set the following parameters:

- Block ID: 3;
- Entity List: Surface;
- Entity ID (s): 8.

Click **Apply**.

4. Set the block parameters.

On the command panel, select the mode for setting material properties (Mode - **Blocks**, Entity - **Block**, Action - **Block properties/parameters**).

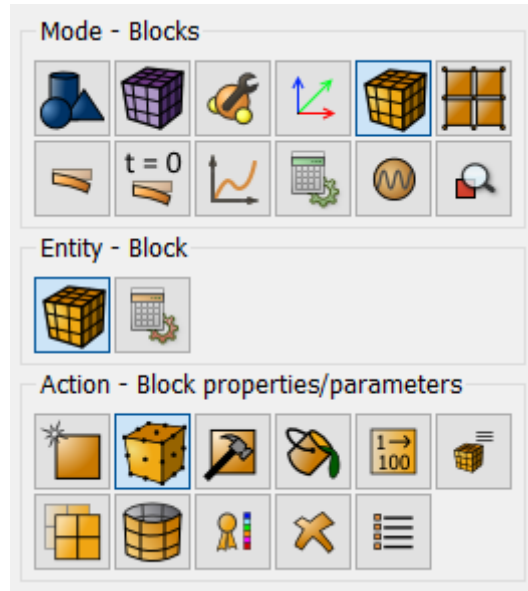

Set the following parameters:

- Block ID(s): all;
- Available materials: Material 1;
- Coordinate System: Global Cartesian;
- Category: Solid;
- Order: 2.

Click **Apply**.

Starting calculation

1. Set the type of problem you want to solve.

On the command panel, select the calculation settings module (Mode - **Calculation Settings**, Calculation Settings - **Static**, Static - **General**).

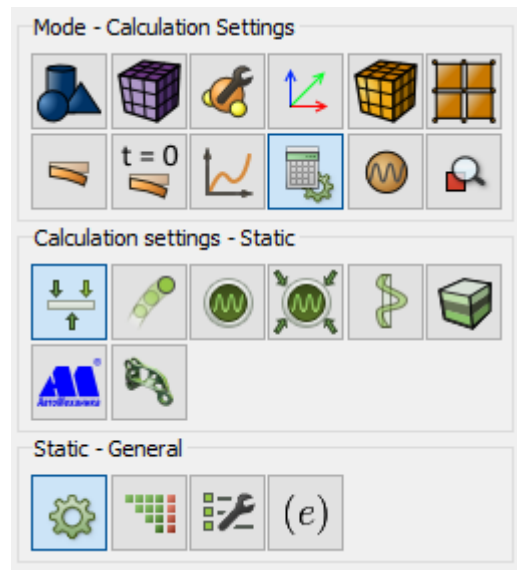

- Dimensions: 2D;
- Plane state: Plane strain;
- Model: Elasticity, Plasticity;
- Load steps count: 3.

Click on the three dot icon in order to configure the active calculation steps for block 2 - 1 2 (separated by spaces), and for block 3 - 1.

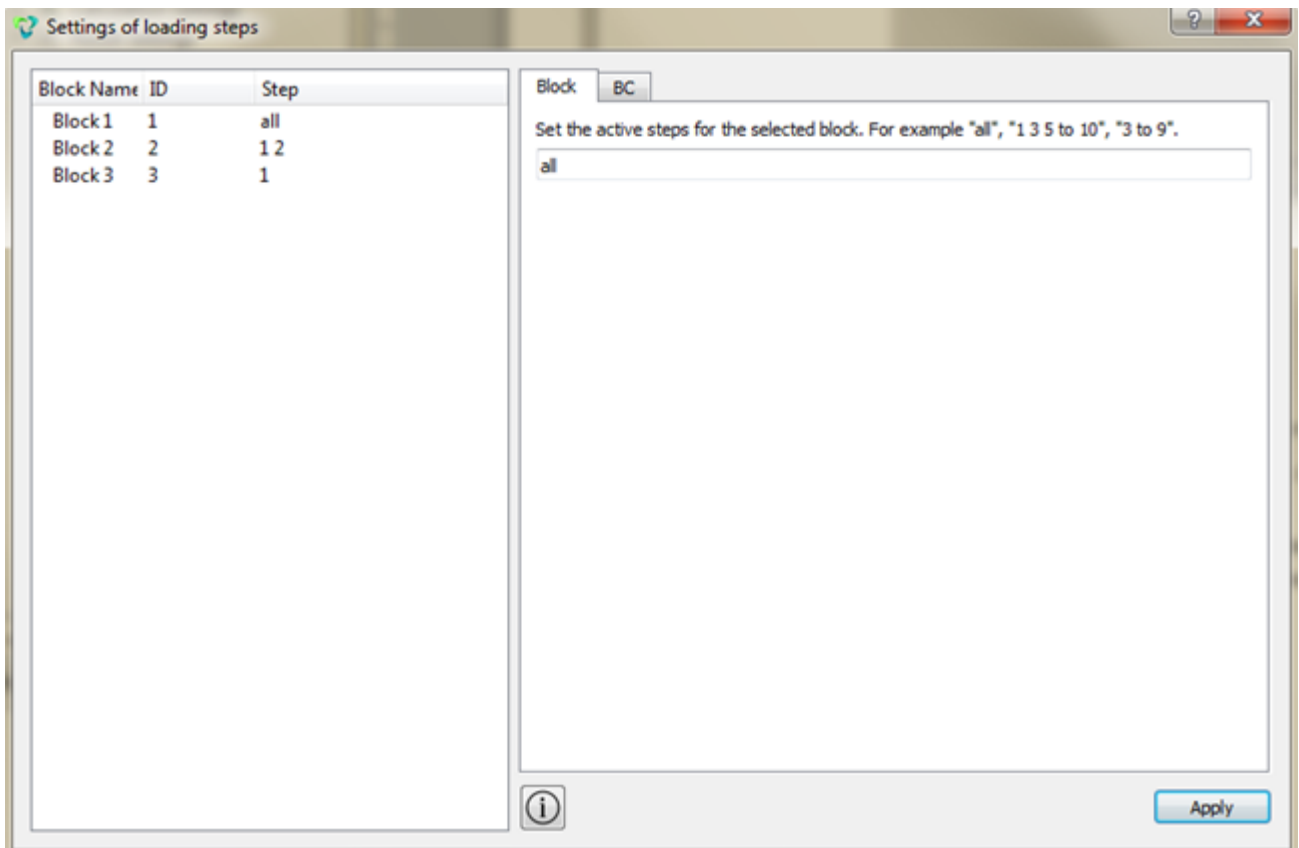

Click **Apply**,

Click **Start Calculation**.

2. In the window that appears, select the directory in which the result will be saved, and enter the file name.
3. In the case of a successful calculation, the console displays the message: Calculation finished successfully at "date time".

Result Analysis

1. Open the file with the results. There are three ways to do that.
 - Press Ctrl+E.
 - From the main menu, select **Calculation** . Click **Open results**.
 - Select **Results** on Command Panel (Mode - **Results**). Click **Open last result**.



For postprocessor analysis, go to the *Fidesys Viewer* window.

2. In the top pane, select the required result data to display. From the first drop-down list, select **Stress**, from the second - **Mises**, from the third - **Surface**.



In the step view panel, set step 1. You should see the image in the initial state. Next, click on Play . 

You should see the sequential removal of layers on the model according to the loading history.

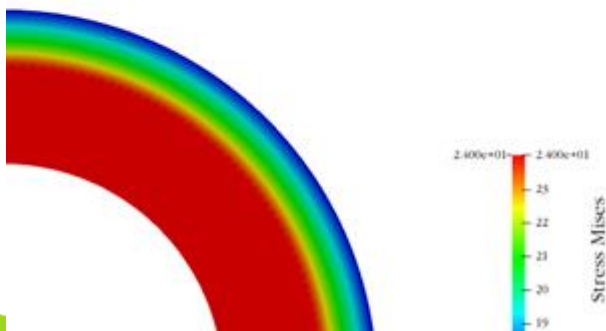
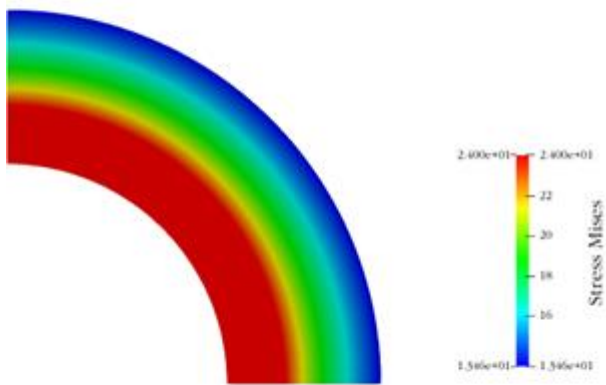
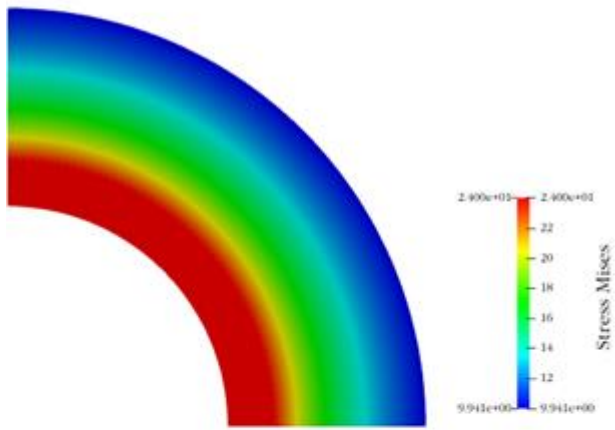
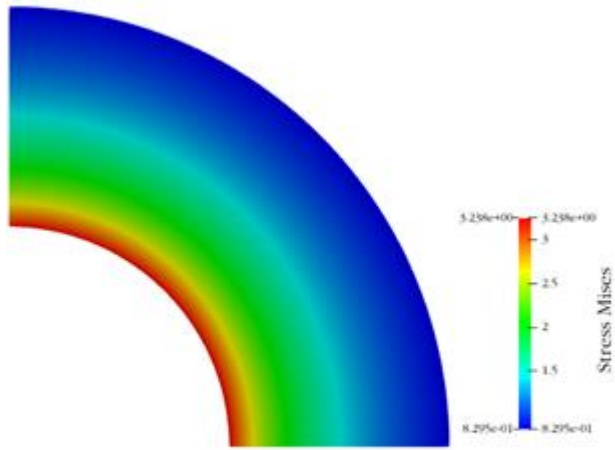

Using the console interface

For geometry generation, meshing, setting boundary conditions and materials you can use Console Interface.



It is also possible to run the *add_layers.jou* by selecting Journal Editor on Toolbar. In a pop-up window of the main menu select **File** → **Open** and open the necessary journal file.

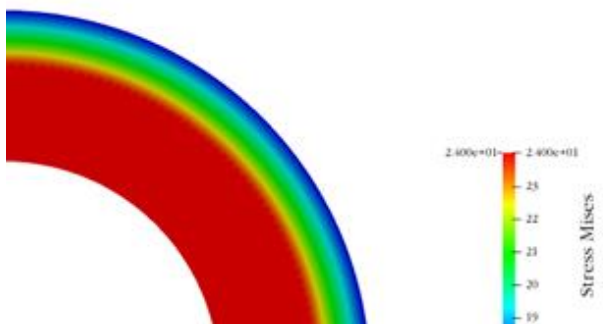
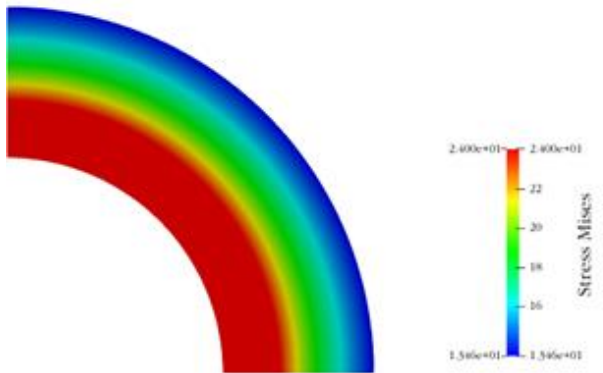
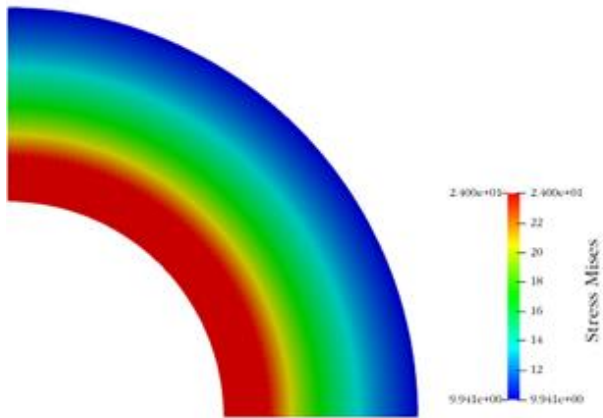
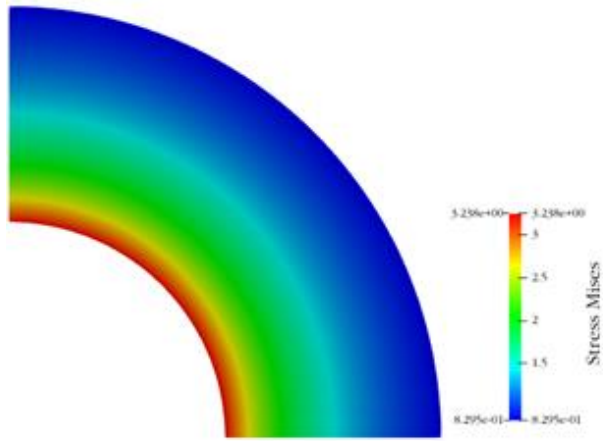

Seismic wave propagation (SEG-Y results)

CAE Fidesys allows you to upload solution results in SEG-Y format. This example considers the propagation of seismic waves in the ground based on the Lamb problem for a 2D case. The procedures for setting receivers, saving and subsequent analysis of data in the SEG-Y format are demonstrated.

The model is a part of the plane (xy), a point force is applied to vertex. Non-reflective boundary conditions are applied.

Geometry creation

1. Create a square plate.

On the command panel, select the mode for creating volume geometry (Mode - **Geometry**, Entity - **Surface**, Action - **Create**).

From the list of geometric primitives, select **Rectangle**. Set block sizes:

- Width: 1000;
- Location: ZPlane.

Click **Apply**.

2. Due to symmetry, we consider half of the model.

On the command panel, select the mode for creating volume geometry (Mode - **Geometry**, Entity - **Surface**, Action - **Webcut**).

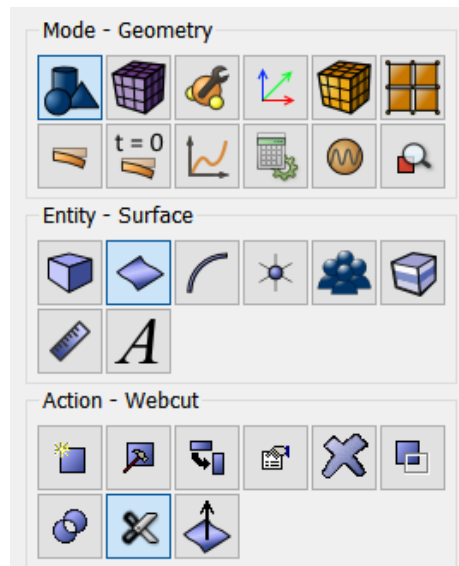
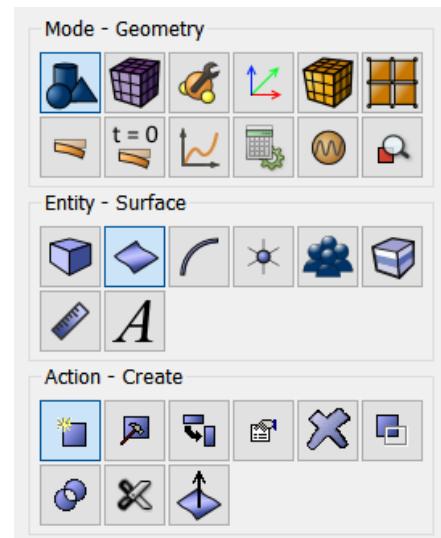

From the list of possible kind of webcuts, select **Coordinate Plane**. Set the following parameters:

- Body ID(s): 1 (the body to be cut);
- Cut: YZ;
- Offset Value: 0.

Click **Apply**.

Do the same, but in the ZX plane.

- Body ID(s): 1 (the body to be cut);
- Cut: ZX;
- Offset Value: 0.

Click **Apply**.

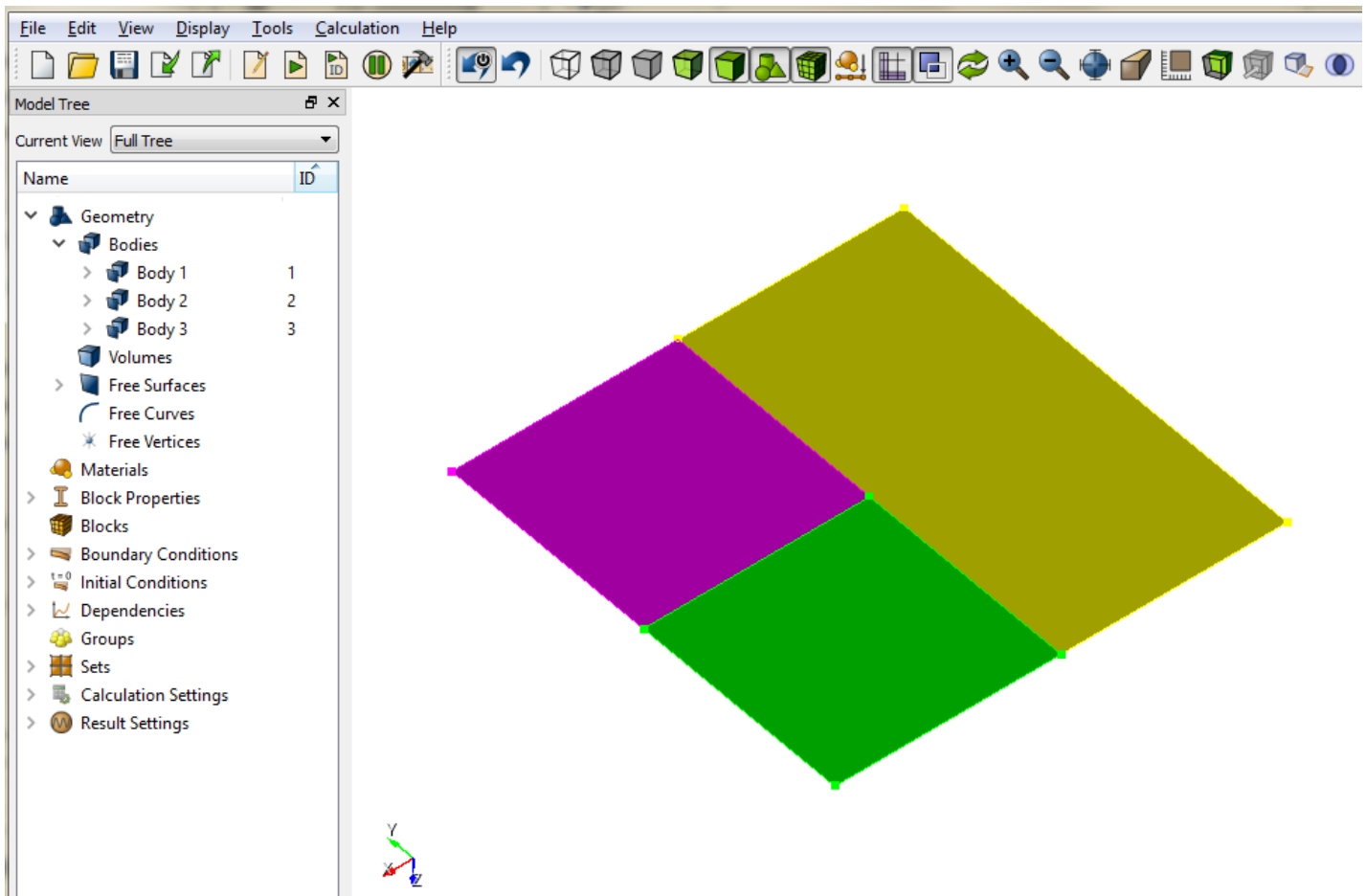

As a result, the original Body 1 in the Model Tree will be divided into three bodies (Body 1, Body 2 and Body 3).

3. Delete Surface 3.

On the command panel, select the mode for creating volume geometry (Mode - **Geometry**, Entity - **Surface**, Action - **Delete**).

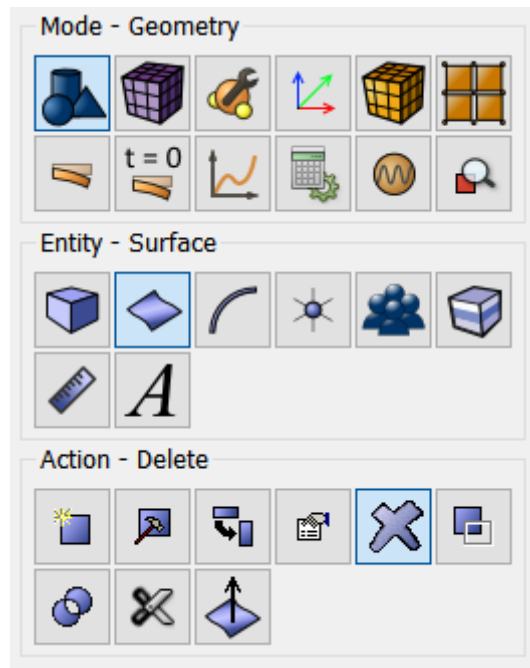

Set the parameters:

- Surface ID (s): 3.

Click **Apply**.

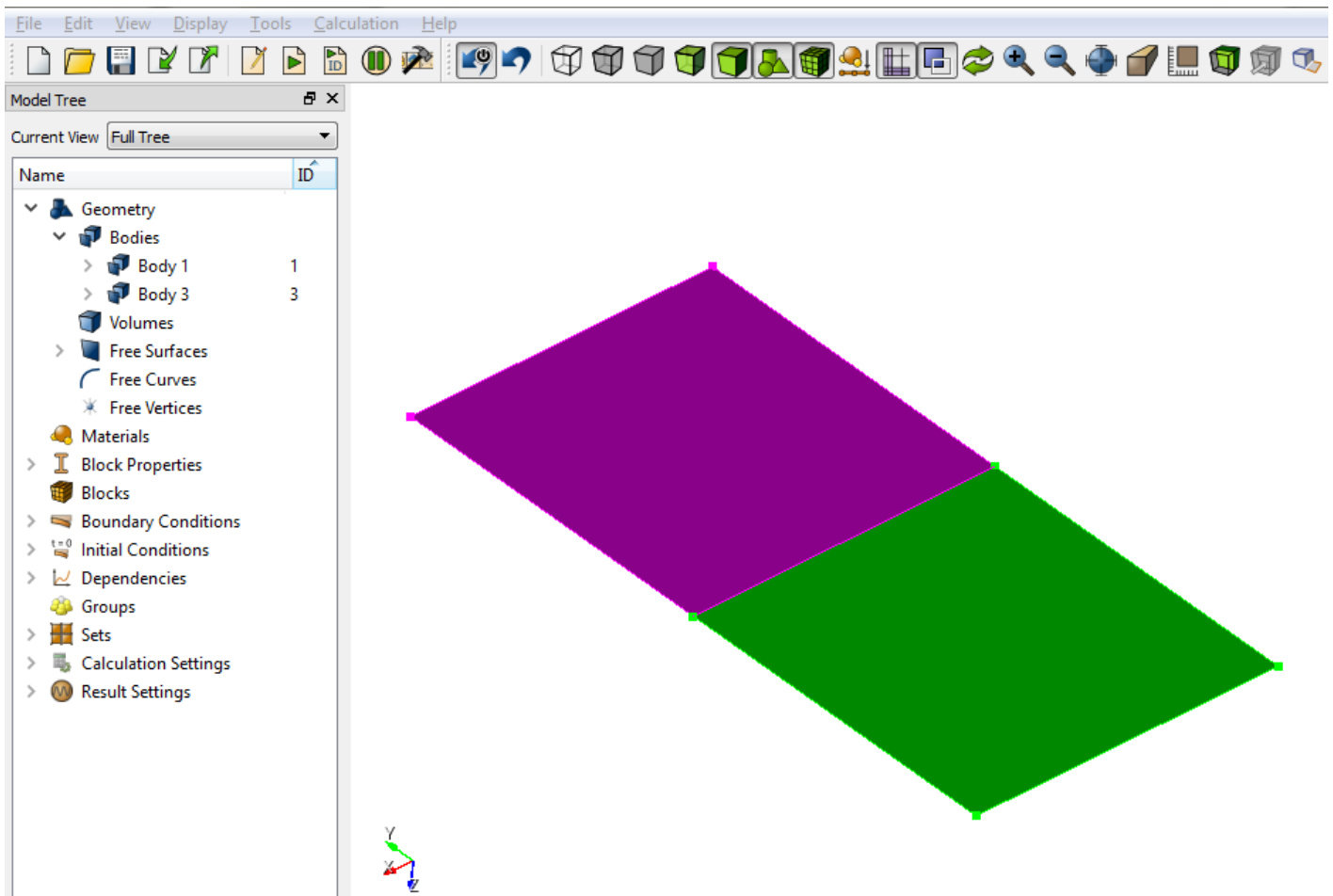

4. Print and splice the surface.

On the command panel, select the module for constructing volumetric geometry (Mode - **Geometry**, Entity - **Surface**, Action - **Transform**).



Set the following parameters:

- Surface ID(s): all.

Click **Apply**.

5. Rotate the model.

On the command panel, select the mode for creating volume geometry (Mode - **Geometry**, Entity - **Surface**, Action - **Transform**).



Select **Rotate** in the list of operations. Set the following parameters:

- Surface ID(s): all;
- Angle: -90;

- Rotate About: Z-Axis.

6. Write the following commands on the command line:

- imprint all;
- merge all.

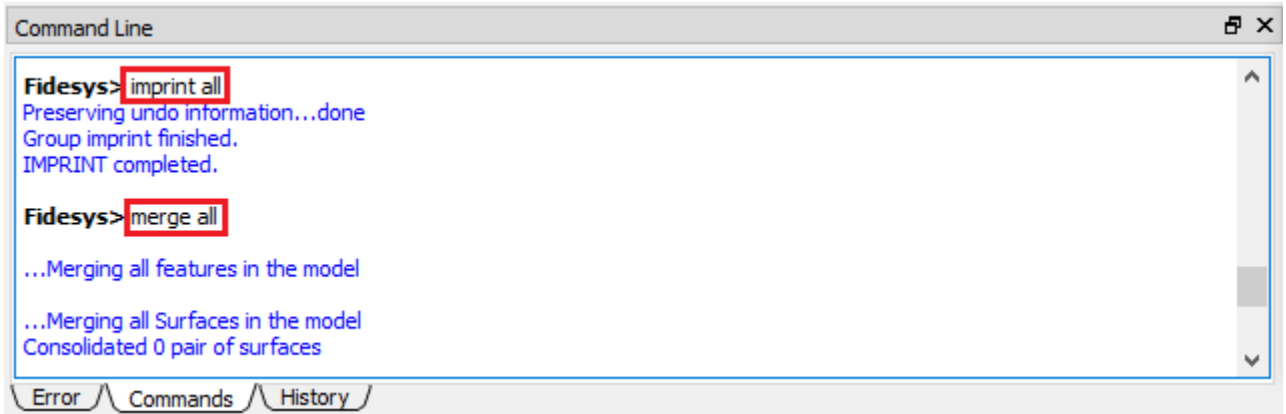

Meshing

1. On the command panel, select the curve meshing mode (Mode - **Mesh**, Entity - **Surface**, Action - **Intervals**).

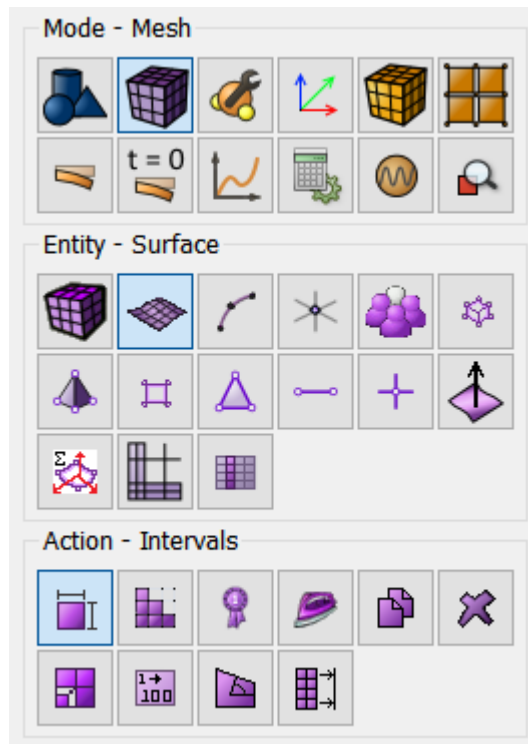

Specify the degree of mesh refinement:

- Approximate Size;
- Select Surfaces: all;
- Approximate Size: 7.

Click **Apply Size**.

Click **Mesh**.

Specifying the material and block properties

1. On the command panel, select the mode for setting material properties (Mode - **Material**, Entity - **Materials Management**).

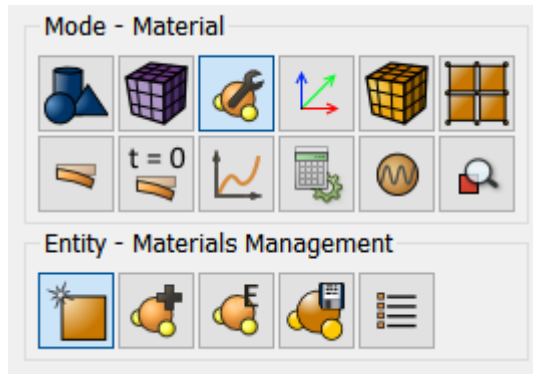

From the Imported Material list, drag the Soil to the Material ID window.

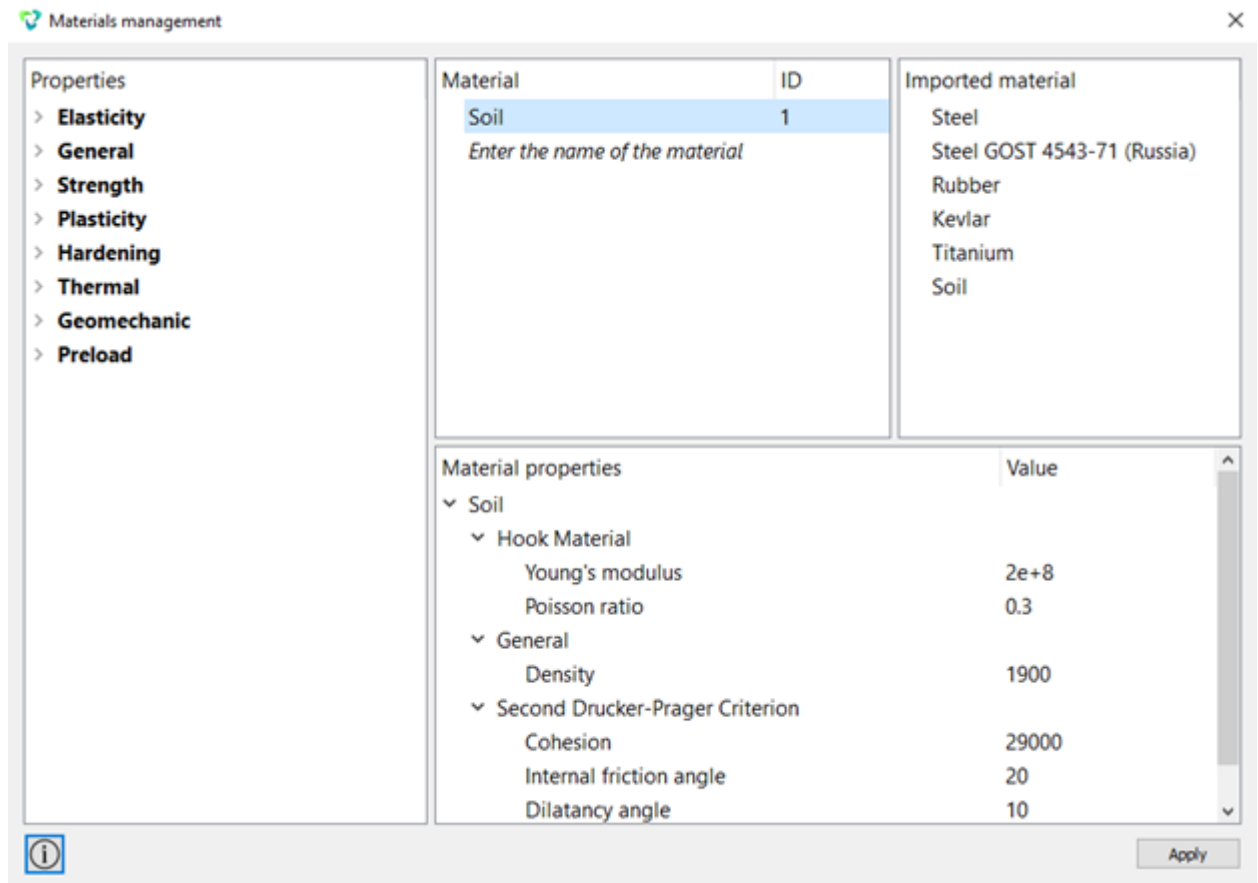

Click **Apply**.

2. Create a block of one material type.

On the command panel, select the mode for setting material properties (Mode - **Blocks**, Entity - **Block**, Action - **Add**).

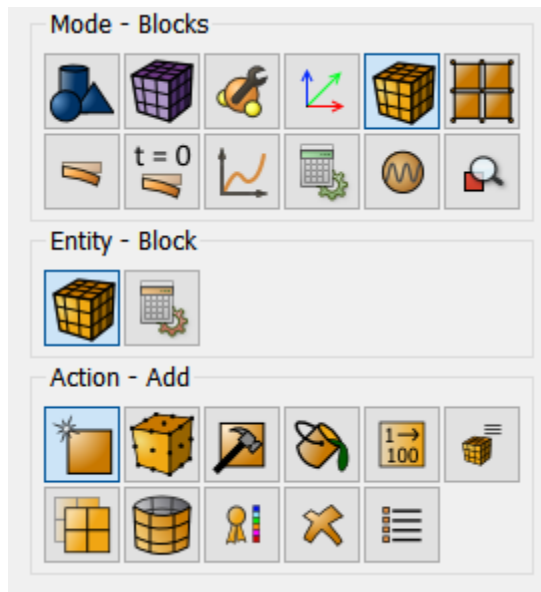

Set the following parameters:

- Block ID: 1;
- Entity List: Surface;
- Entity ID(s): All.

Click **Apply**.

3. Set the block parameters.

On the command panel, select the mode for setting material properties (Mode - **Blocks**, Entity - **Block**, Action - **Block properties/parameters**).

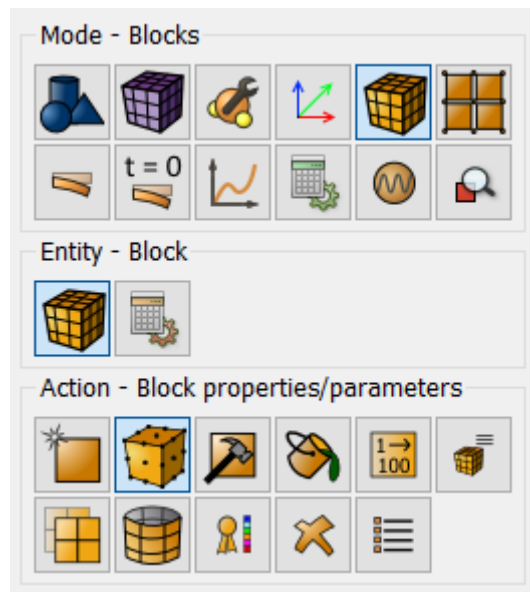

Set the following parameters:

- Block ID(s): 1;

- Material: Soil;
- Coordinate System: Global Cartesian;
- Category: Plane;
- Order: 4.

Click **Apply**.

Setting boundary conditions

1. Set non-reflective boundary conditions.

On the command panel, select (Mode - **Boundary Conditions**, Entity – **Absorbing Condition**, Action - **Create**).



Set the following parameters:

- System Assigned ID;
- Entity List: Curve;
- Entity ID(s): 7 15 13 6 (separated by spaces).

Click **Apply**.

2. Set the force.

On the command panel, select (Mode - **Boundary Conditions**, Entity - **Force**, Action - **Create**).

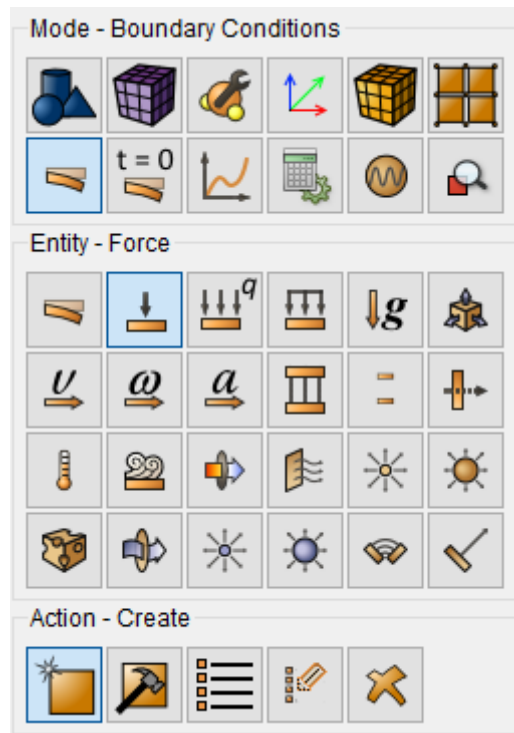

Set the following parameters:

- System Assigned ID;
- Force Entity List: Vertex;
- Entity ID(s): 10;
- Force: 1;
- Direction: 0 -1 0 (space separated).

Click **Apply**.

Set the BC dependency on time and / or coordinates

1. Create a formula 1 for strength 1.

On the command panel, select (Mode – **BC Dependency**).

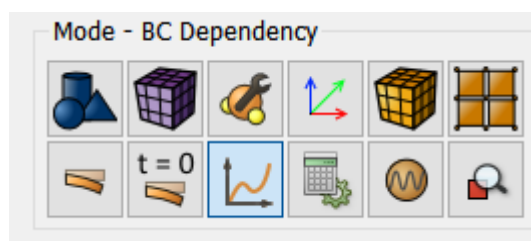

Click Force 1 and choose Formula panel in the right. Then choose Berlage and set the following parameters:

- Select the flag Formula: Berlage;
- Amplitude: 2e8;
- Frequency: 10.

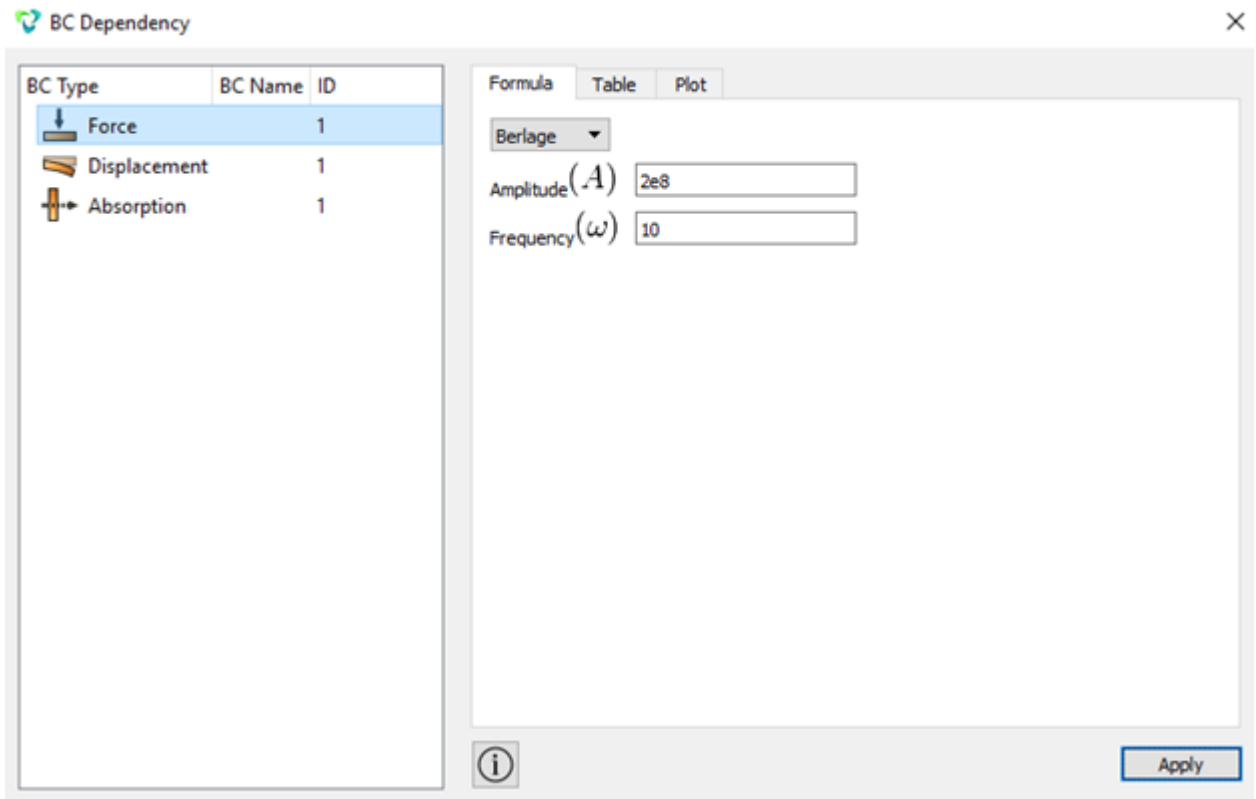

Click **Apply**.

Receivers

1. Create receivers on curve 16 along all directions.

On the command panel, select (Mode - **Receivers**, Operation - **Create**).



From the drop-down list, select the fields whose data you want to save in SEG-Y format. Set the following parameters:

- System Assigned ID;
- Entity List: Curve;
- Entity ID(s): 16;
- Velocity;
- Variables: All.

Click **Apply**.

Repeat all the steps with the same parameters for each field in the drop-down list (velocity, principal stresses, pressure).

The receiver lines are highlighted on the model in yellow when clicked in the corresponding section of the Model Tree.

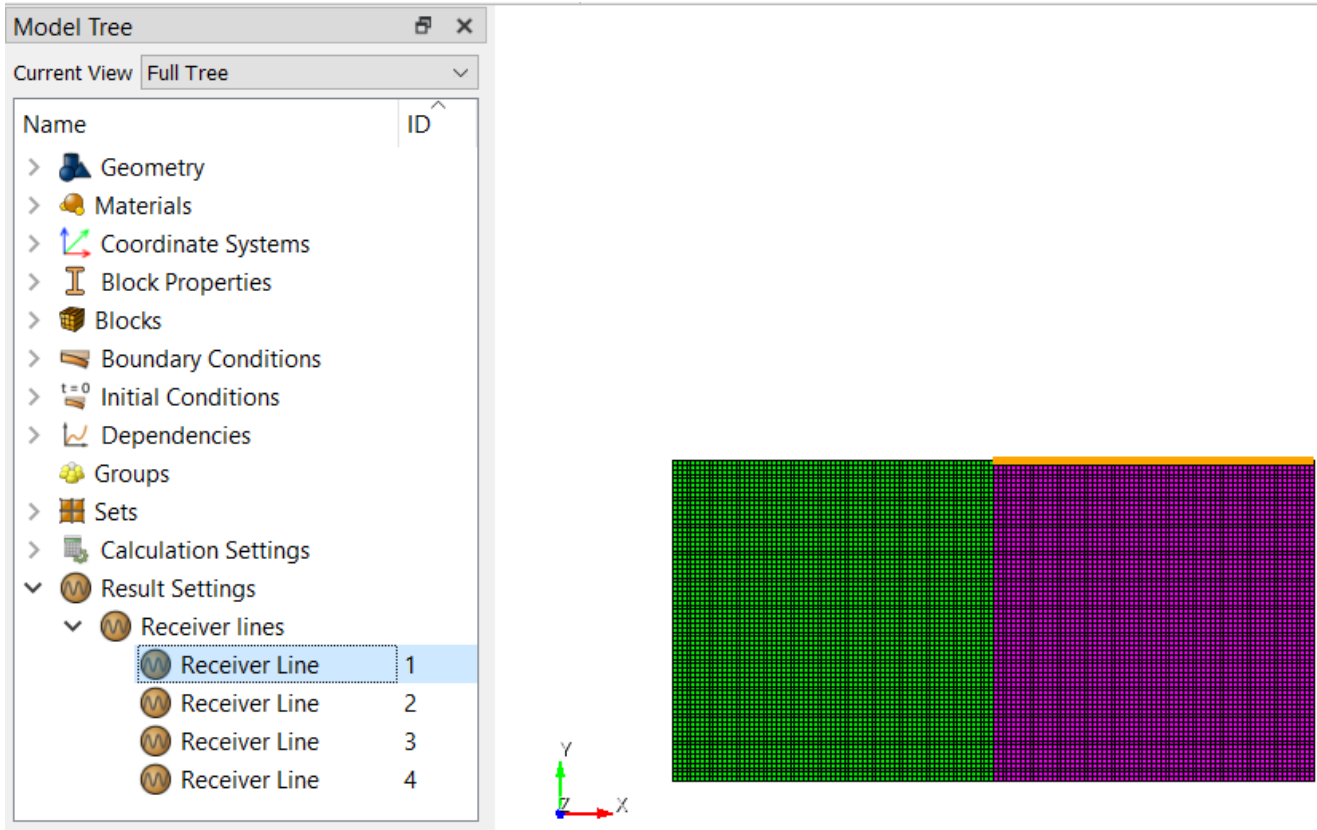

Starting calculation

1. Set the type of problem you want to solve. On the command panel, select the calculation settings mode (Mode - **Calculation Settings**, Calculation Settings - **Transient analysis**, Transient - **General**).

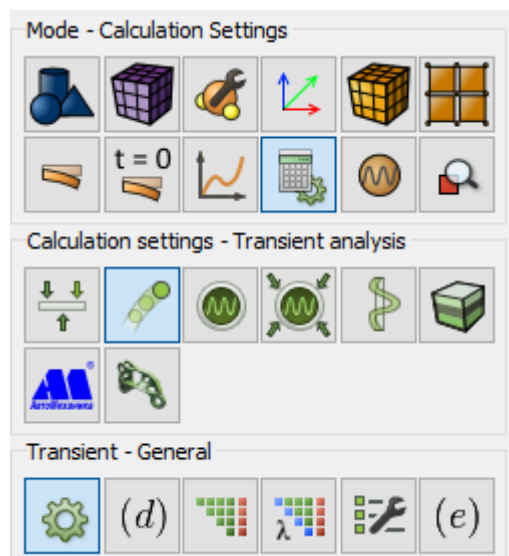

Set the following calculation parameters:

- Dimension: 2D;
- Method: Full solution;
- Scheme: Explicit;
- Max time: 5;
- Max steps count: 2025;
- Preload model: uncheck;

Click **Apply**.

Go to the settings section for **Output Fields**. Specify:

- Save Results: Every 135 Steps

Click **Apply**.

Click **Start Calculation**.

2. In the window that appears, select the directory in which the result will be saved, and enter the file name.
3. In case of a successful calculation, a message will be displayed in the console: “Calculation finished successfully at "date time"”.

Results analysis

1. Open the file with the results. There are three ways to do that.

- Press Ctrl+E.
- From the main menu, select **Calculation** . Click **Open results**.
- Select **Results** on Command Panel (Mode - **Results**). Click **Open last result**.



2. To analyze the results, go to the *Fidesys Viewer*.

1. On the top bar, select the required result data to display. From the first drop-down list, select **Stress**, from the second - **Mises**.

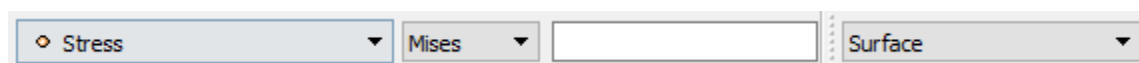

4. Set the step 1 in the step viewer panel. You should see the plate image in the initial state. Next, click on Play  . You should see the propagation of stress over time.

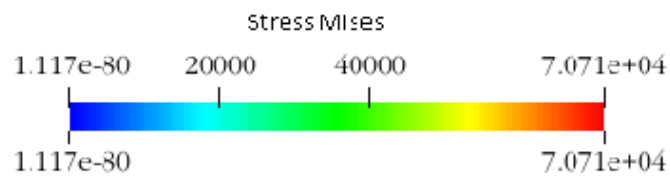
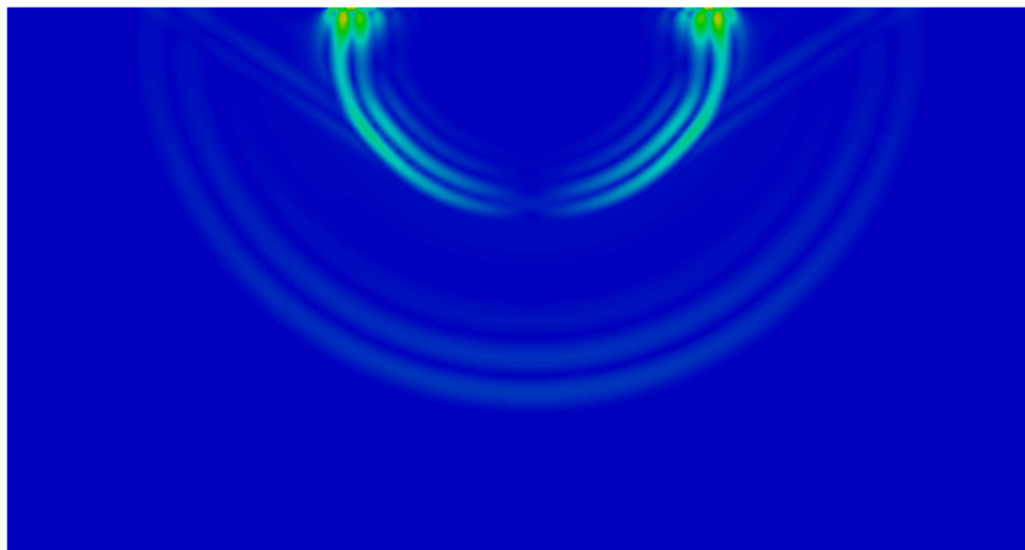

5. Open the saved data in SEG-Y format.

To do this, go to **Menu - File - Open**. In the drop-down list of file types, select SEG-Y Files (*.sgy, *.seg). Specify the file to view **test_Vy.sgs**

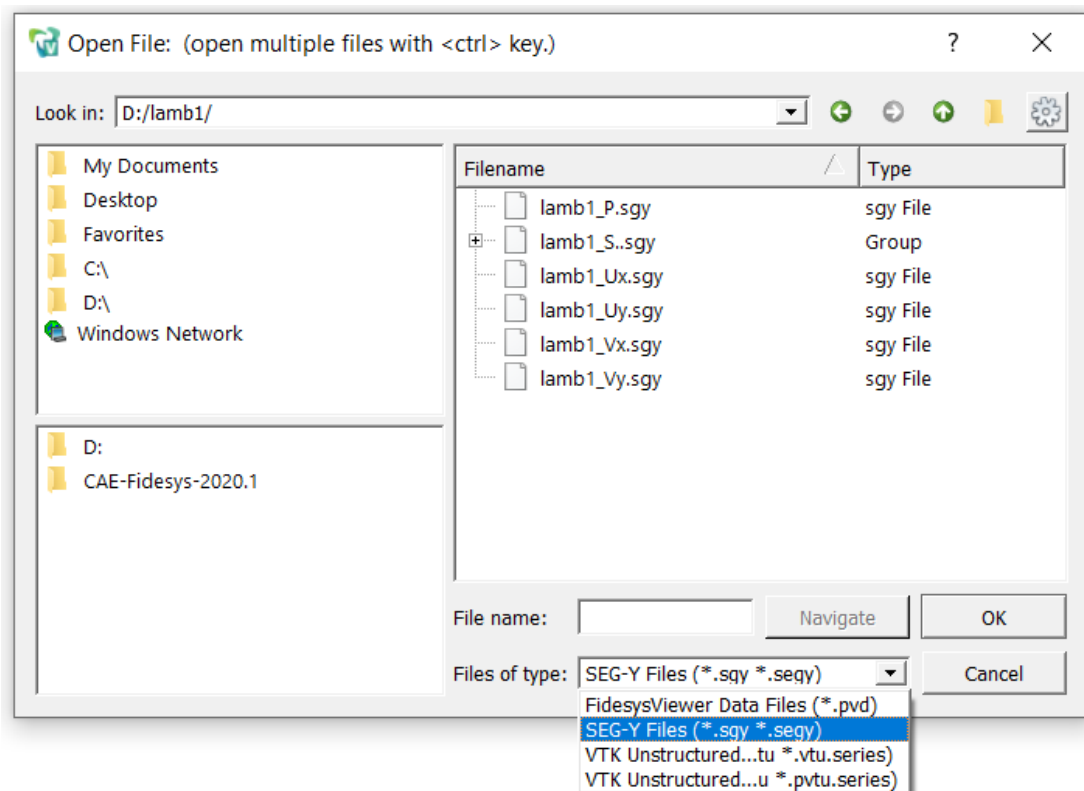

Set the viewing direction along the Y axis.



The calculation results for displacement U_y in the SEG-Y format are visualized in the field of visualization.



Using the console interface

For geometry generation, meshing, setting boundary conditions and materials you can use Console Interface.



It is also possible to run the *boussinesq_problem_seg.y.jou* by selecting Journal Editor on Toolbar. In a pop-up window of the main menu select **File** → **Open** and open the necessary journal file.

Porosity-Elastic-Plastic Well Model (2D)

Stress-strain state in the vicinity of a vertical well of radius R_w drilled to a depth of h is determined. The reservoir is considered to be isotropic and homogeneous. The problem is solved in a cylindrical coordinate system.

Geometry creation

1. Create the first circle with radius 10.

On the command panel choose (Mode — **Geometry**, Entity— **Surface**, Action — **Create**).

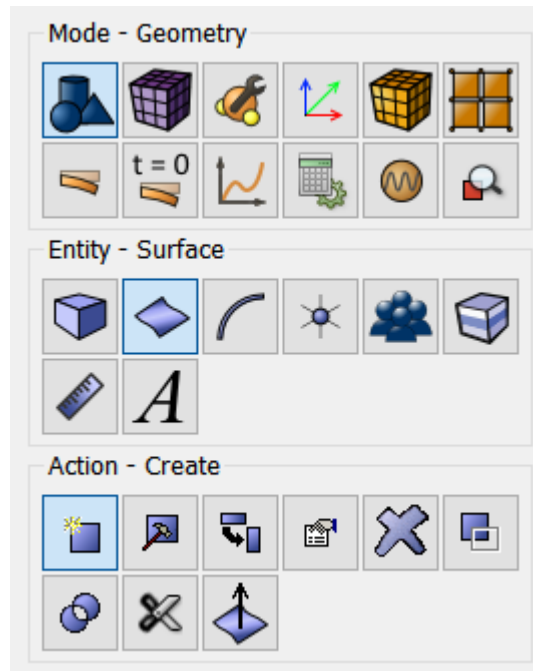

Select **Circle** in the list of geometric elements. Set block sizes:

- Radius: 10;
- Location: Z-plane.

Click **Apply**.

2. Create the second circle with radius 1.

On the command panel, select the mode for creating volume geometry (Mode - **Geometry**, Entity - **Volume**, Action - **Create**).

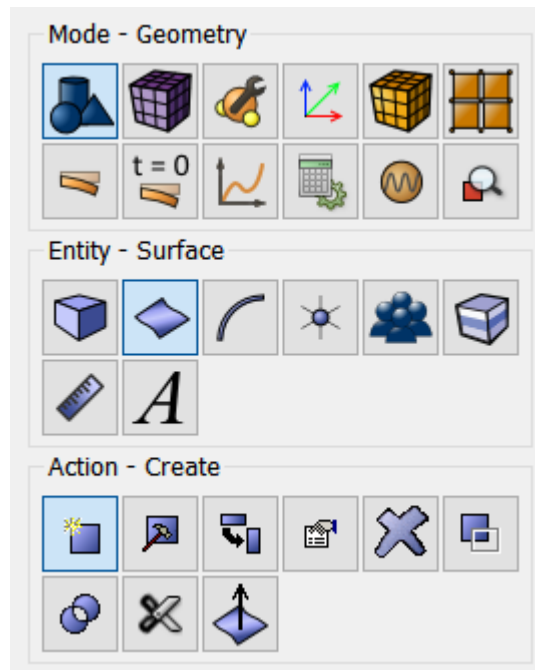

From the list of geometric primitives, select **Circle**. Set block sizes:

- Radius: 1;
- Location: Z-plane.

Click **Apply**.

3. Subtract the first circle from the second one.

Select volume geometry generation section on Command Panel (Mode — **Geometry**, Entity — **Surface**, Action — **Boolean**).

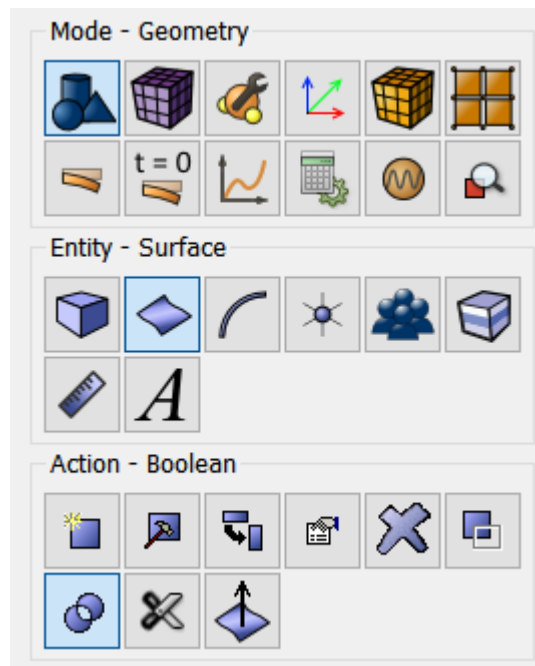

Select **Subtract** in the list of operations. Set the following parameters:

- A Surface ID(s): 1;
- B Surface ID(s): 2.

Click **Apply**.

As a result, only one body (Body 1) will remain in the object tree.

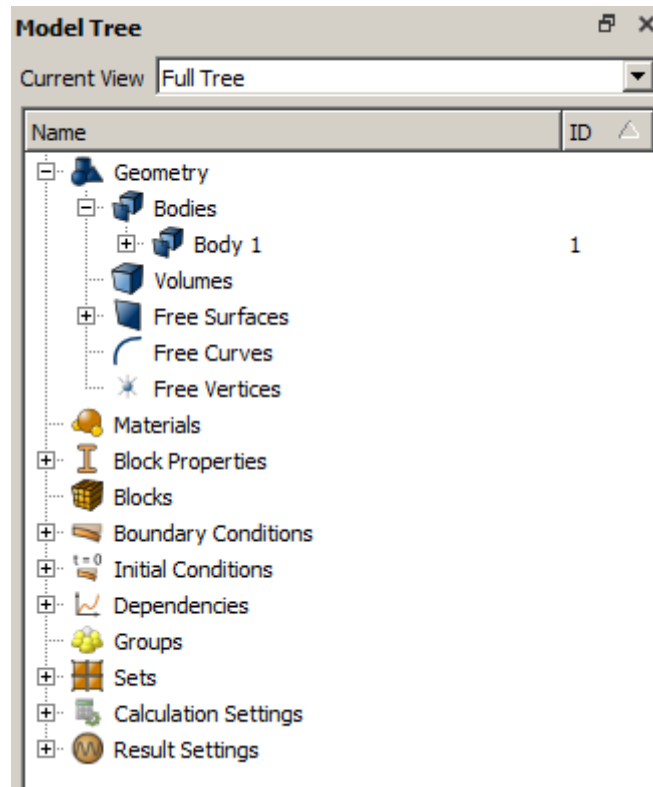

4. Leave a quarter of the volume (condition of symmetry).

Select volume geometry generation section on Command Panel (Mode — **Geometry**, Entity — **Surface**, Action — **Webcut**).

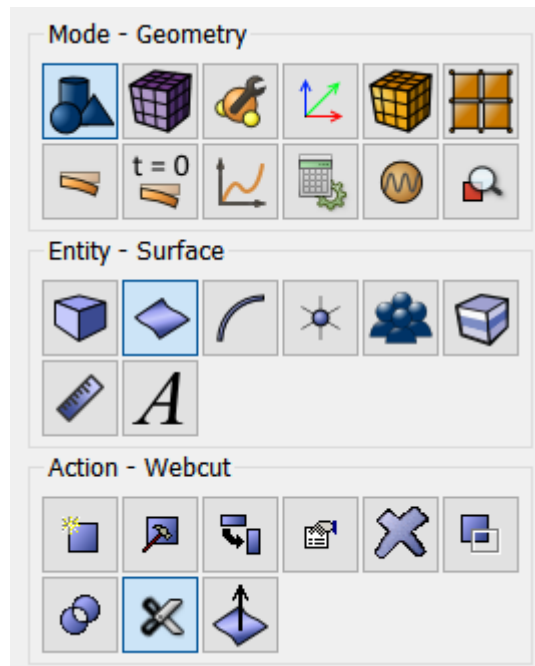

From the list of available section views select **Coordinate Plane**. Set the following parameters:

- Body ID(s): 1;
- Cut: Plane ZX;
- Offset Value: 0.

Click **Apply**.

Do the same, but in the YZ plane:

- Body(ies) ID: 3;
- Cut: Plane YZ;
- Offset Value: 0.

Click **Apply**.

Then delete volumes 4 and 1.



Select volume geometry generation section on Command Panel (Mode — **Geometry**, Entity — **Volume**, Action — **Delete**).



Set the following parameters:

- volume ID(s): 4 1 (separated by a space).

Click **Apply**.

Setting material

On the command panel, select the module for setting material properties (Mode — **Material**, Entity — **Material management**).

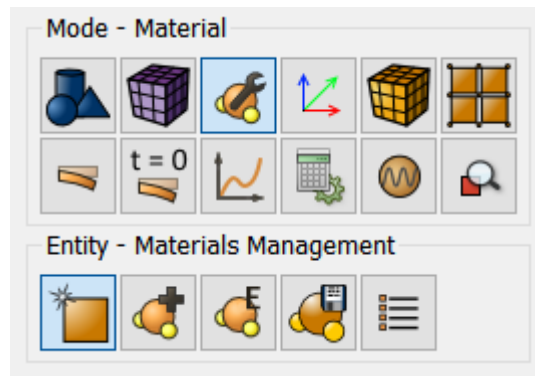

Specify the name of the material Material 1. Expand the item Elasticity in the left column and drag the Hooke Material to the Material Properties column. Set the following parameters:

- Young's modulus: $1e9$;
- Poisson's ratio: 0.25 ;

Expand Plasticity in the left column and drag the Second Drucker-Prager Strength Criterion into the Material Properties column. Set the following parameters:

- Cohesion: $5.43712e+6$;
- Internal friction angle: 21.43 ;
- Dilatancy angle: 21.43 .

Expand Geomechanics in the left column and drag Bio Isotropic Model to the Material Properties column. Set the following parameters:

- Porosity: 0.25 ;
- Permeability: $1e-12$;
- Fluid's viscosity : 0.005 ;
- Biot alpha: 1 ;
- Fluid's bulk modulus: $1e+9$;
- Fluid's density: 1000 .

The **Materials management** dialog box is shown with the **Material** tab selected. The **Material** list shows **Material 1** with ID **1**. The **Imported material** list includes **Steel**, **Steel GOST 4543-71 (Russia)**, **Rubber**, and **Kevlar**. The **Material properties** table is displayed with the following values:

Material properties	Value
Material 1	
Hook Material	
Young's modulus	1e+09
Poisson ratio	0.25
Second Drucker-Prager Criterion	
Cohesion	5.43712e+06
Internal friction angle	21.43
Dilatancy angle	21.43
Biot Isotropic model	
Porosity	0.25
Permeability	1e-12
Fluid's viscosity	0.005
Biot alpha	1
Fluid's bulk modulus	1e+09
Fluid's density	1000

An information icon and the text *Drag the desired property from the 'Properties' window* are located at the bottom left. An **Apply** button is at the bottom right.

Click **Apply**.

Meshing

1. Select meshing on curves section on Command Panel (Mode — **Mesh**, Entity — **Curve**, Action — **Mesh**).

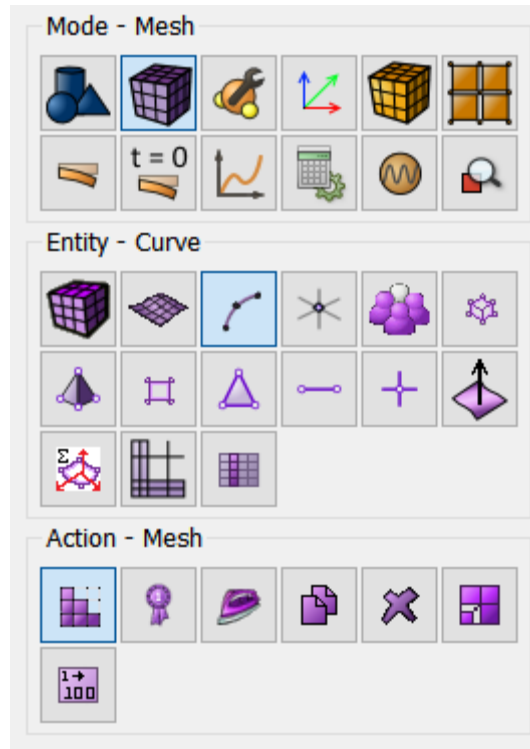

Specify the parameters of mesh refinement:

- Selection curves: 8;
- Bias;
- Intervals and Bias;
- Interval Count: 90;
- Bias Factor: 1.05;
- Start Vertex ID: 7.

Click **Apply**.

2. Select meshing on curves section on Command Panel (Mode — **Mesh**, Entity — **Curve**, Action — **Mesh**). Specify the parameters of mesh refinement:

- Selection curves: 12;
- Bias;
- Intervals and Bias;
- Interval Count: 90;
- Bias Factor: 1.05;
- Start Vertex ID: 11.

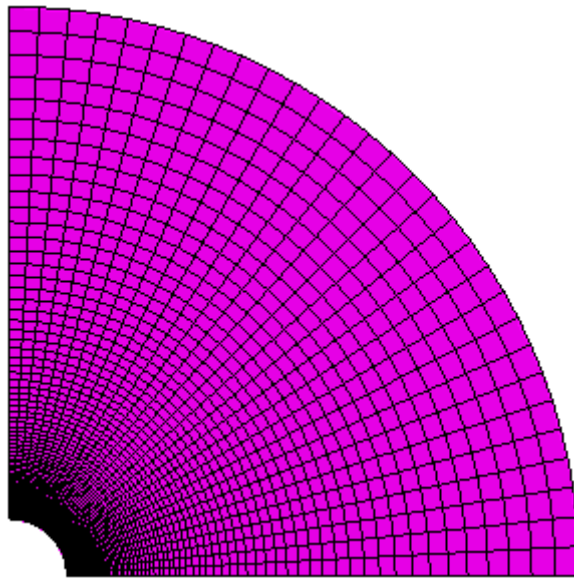

Setting boundary conditions

1. Attach curves 8 and 12 in the direction Y and X respectively.

On the command panel, select Mode - **Boundary Conditions**, Entity - **Displacement**, Action - **Create**.

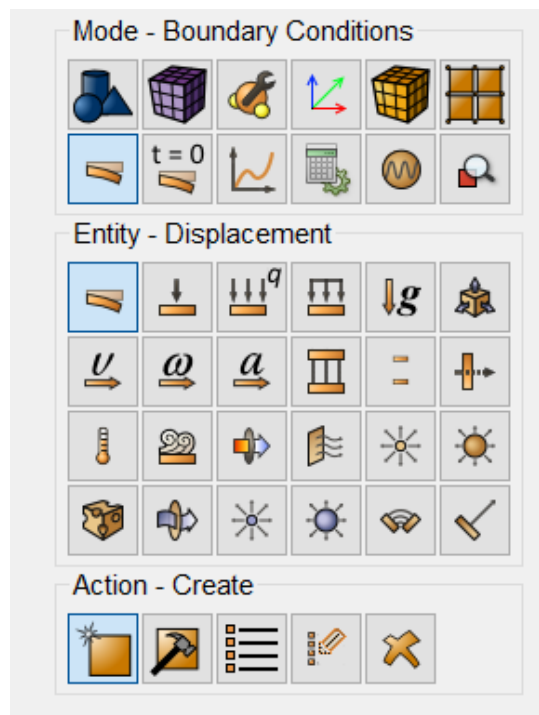

Set the following parameters:

- System Assigned ID;
- Entity List: curve;
- Entity ID(s): 8;
- Degrees of Freedom: Y-Translation Disp;

3. Set the pressure on curves 13 and 14.

On the command panel, select Mode - **Boundary Conditions**, Entity – **Pore Pressure**, Action - **Create**.

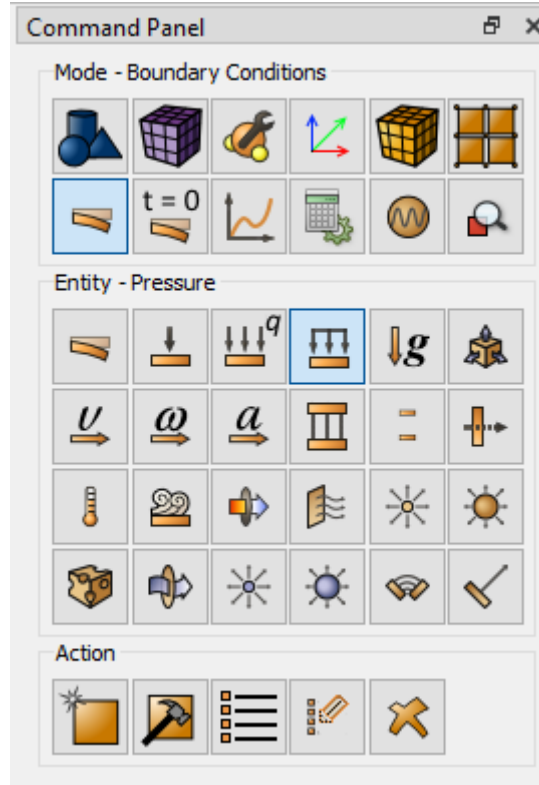

Set the following parameters:

- System Assigned ID;
- Pressure Entity List: curve;
- Entity ID(s): 13;
- Magnitude Value: $4e+7$;

Click **Apply**.

Set the following parameters:

- System Assigned ID;
- Pressure Entity List: curve;
- Entity ID(s): 14;
- Magnitude Value: $8e+7$;

Click **Apply**.

Setting the block properties

1. Create a block of one material type.

On the command panel, select Mode — **Blocks**, Entity — **Block**, Action — **Add entity to block**.

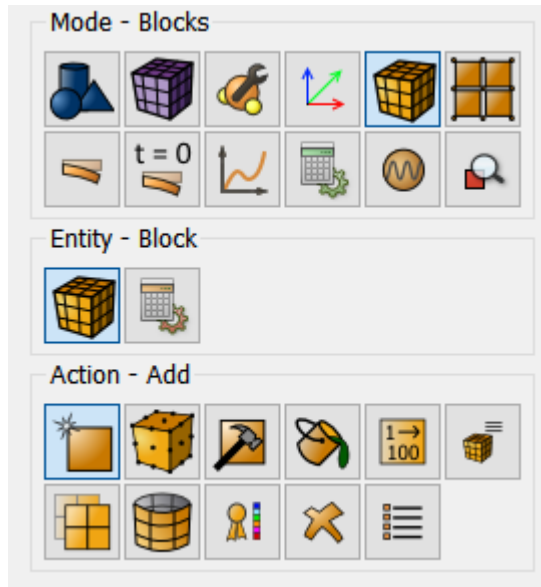

Set the following parameters:

- Block ID: 1;
- Entity List: Surface;
- Entity ID(s): all.

Click **Apply**.

2. Set the block parameters.

On the command panel, select the mode for setting material properties (Mode - **Blocks**, Entity - **Block**, Action - **Block properties/parameters**).

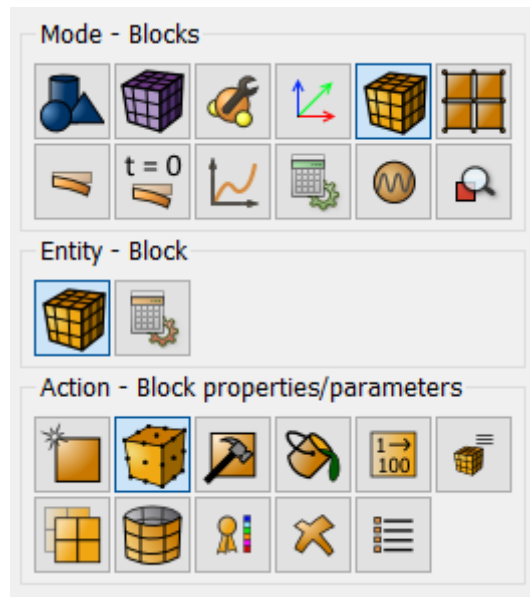

Set the following parameters:

- Block ID(s): 1;
- Available materials: Material 1;
- Coordinate System: Global Cartesian;
- Category: Plane;
- Order: 2.

Click **Apply** .

Starting calculation

1. Set the analysis type.

Select calculation setting section on Command Panel (Mode — **Calculation settings**, Calculation settings — **Static**, Static — **General**).

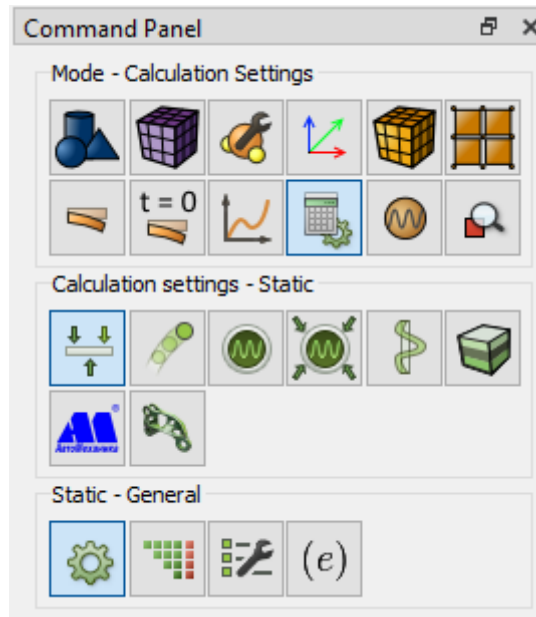

Select:

- Dimension: 2D;
 - Type of plane problem: Plane deformed state;
 - Model: Elasticity, Plasticity, Pore Fluid Transfer;
 - Set the nonlinear solver options;
 - Min load substeps: 30;
 - Max load substeps: 10000000;
 - Max. iterations: 100;
 - Tolerance: 1e-6;
 - Target iterations: 5.

Click **Apply**.

Results analysis

1. Open the file with the results. There are three ways to do it.

- Click Ctrl+E.
- Select **Calculation** → **Open Results** in the Main Menu. Click **Open last result**.
- On the command panel, select the calculation settings module (Mode — **Calculation Settings**, Calculation Settings — **Results**). Click **Open Results**.



2. Go to the Fidesys Viewer to analyze the results .

3. On the toolbar, select **Filters** → **Alphabetical** → **Coordinate System Conversions**. In the **Properties** window that opens, set:

- Scalar Array: Stresses;
- Untick the Spherical coordinates box;
- Cylinder axis: Z.

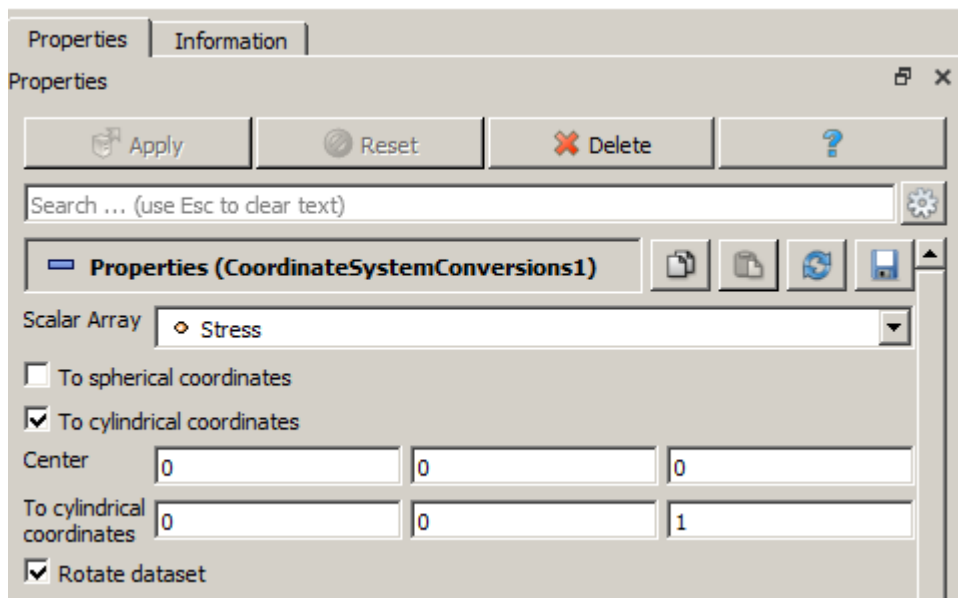

Click **Apply**.

4. Display the $\sigma_{\theta\theta}$ component of the stress field (cylinder) on the model.

On the toolbar, set the following parameters:

- Display type: Surface;
- Display field: Stresses (cyl.);
- Display component: FF.

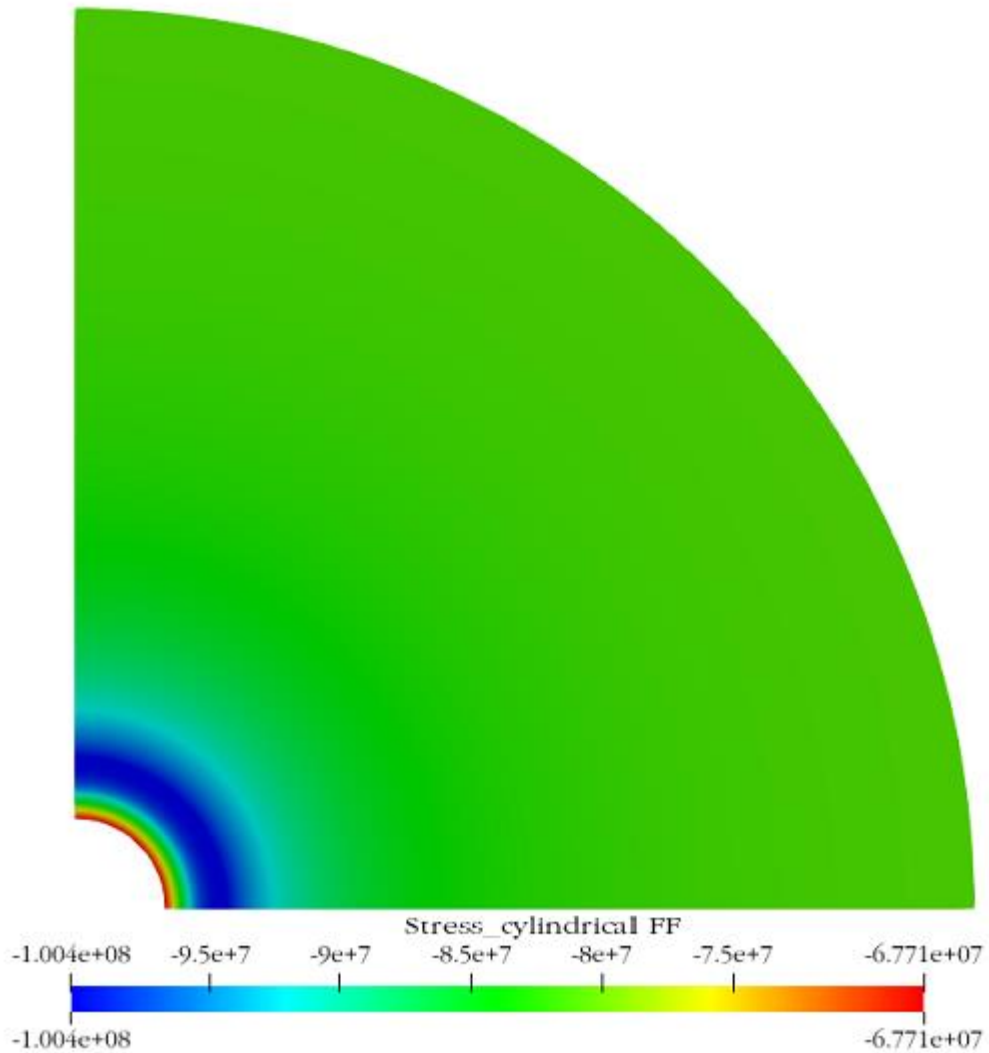

5. On the toolbar, select **Filters** → **Alphabetical** → **Plot Over Line**. In the **Properties** window that opens, set:

- Click Apply;
- Row parameters: untick the Variable box;
- Row parameters: tick the box Stresses_cylindrical_FF.

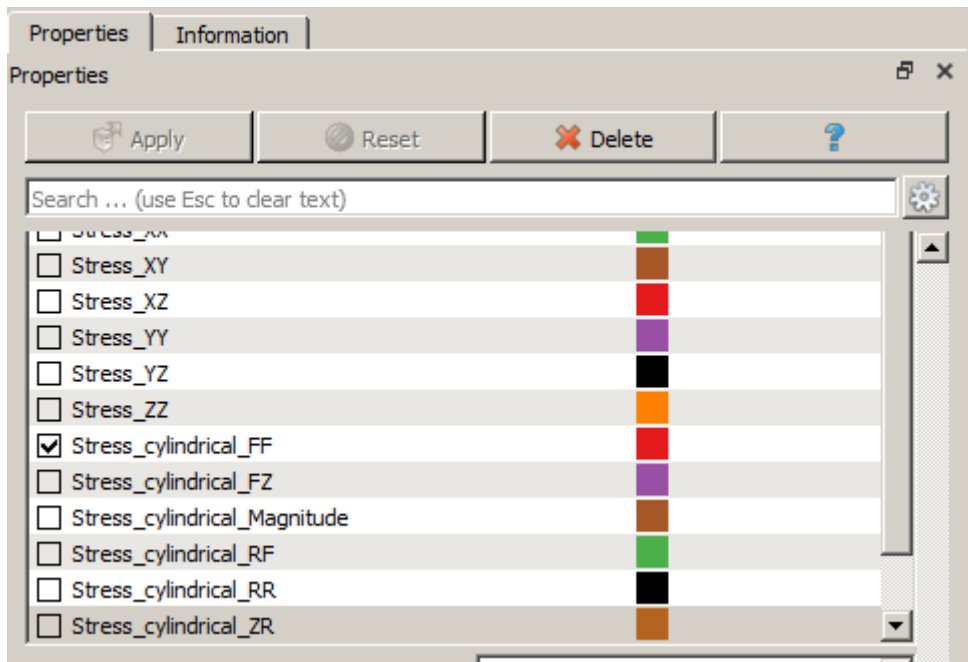

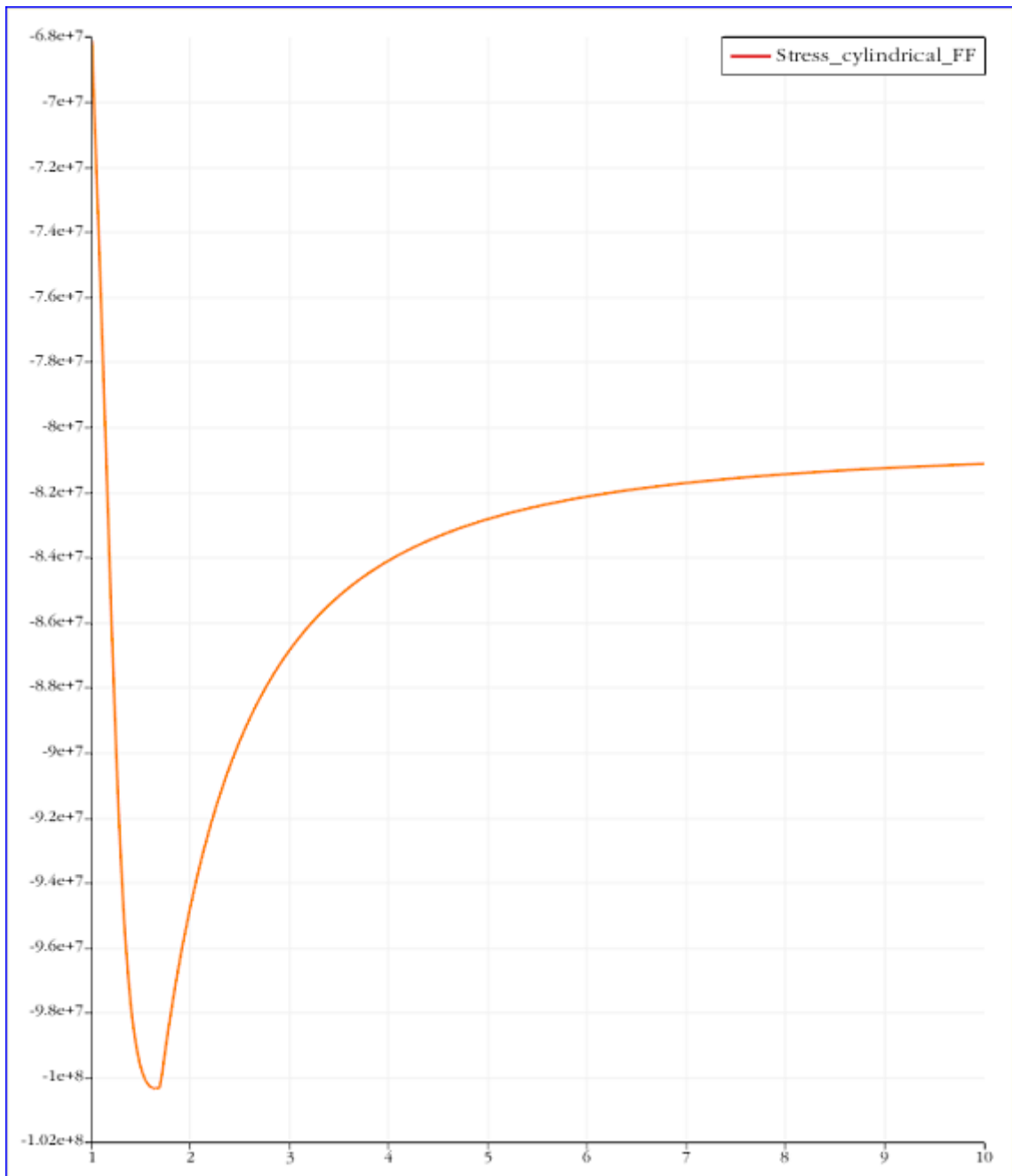

Using Console Interface

For geometry generation, meshing, setting boundary conditions and materials you can use Console Interface.



It is also possible to run the *poroelastoplasticity.jou* by selecting Journal Editor on Toolbar. In a pop-up window of the main menu select **File** → **Open** and open the necessary journal file.

Hertz problem for two hemispheres with contact

In the proposed problem, the Hertz problem is modeled for two hemispheres with contact. The test task is designed to check the correctness:

- setting parameters of sliding contact without friction in the interface;
- static solution with sliding contact without friction for 3D models;
- the correctness of the output of the Stress field, taking into account the contact interaction.

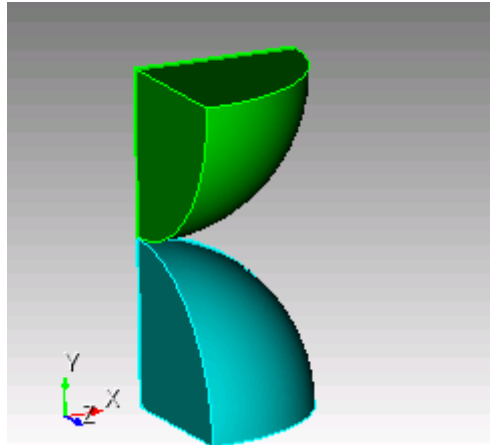

Geometry Creation

1. Create a sphere.

Select volume geometry generation section on Command Panel (Mode - **Geometry**, Entity - **Volume**, Action - **Create**).

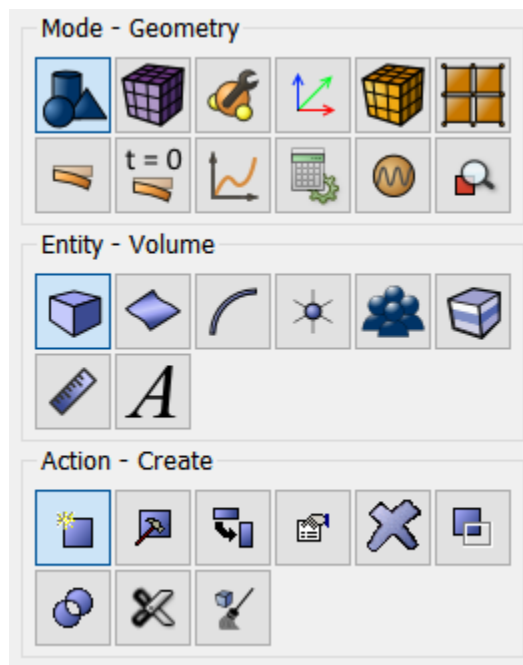

From the list of geometric primitives, select **Sphere**.

Set the following parameters:

- Radius: 50;

Click **Apply**.

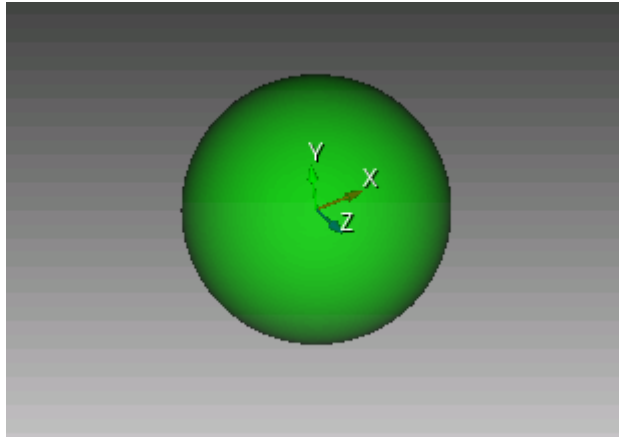

2. Move the spher.

On the command panel, select (Mode - **Geometry**, Entity - **Volume**, Action - **Transform**).

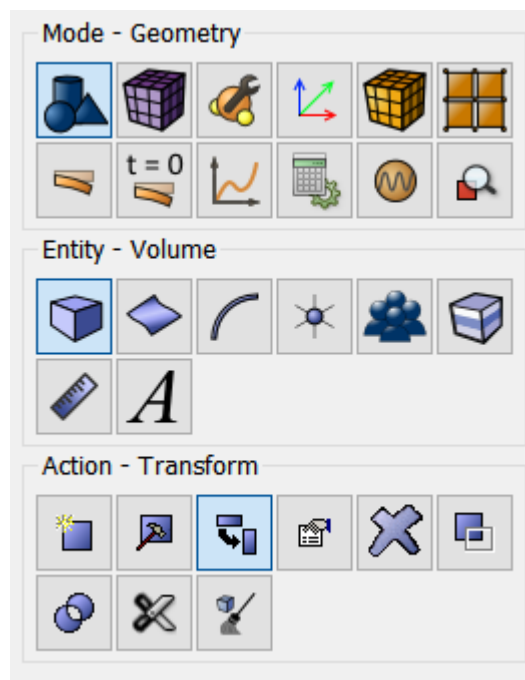

From the list, select **Move**.

Set the following parameters:

- Volume ID(s): 11;
- Include Merged;
- Select Method: Distance;
- Y Distance: 50

Click **Apply**.

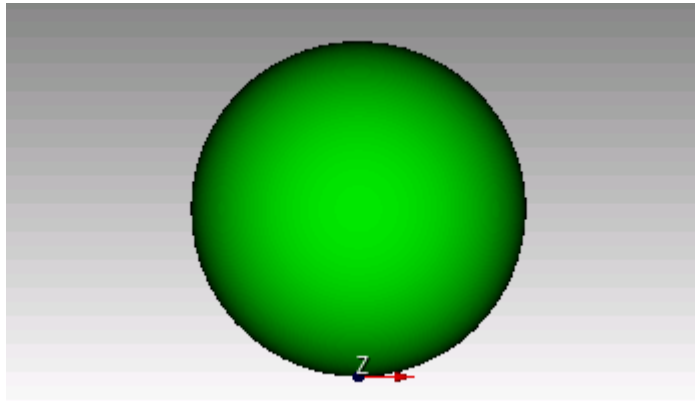

3. Create a second sphere.

Select volume geometry generation section on Command Panel (Mode - **Geometry**, Entity - **Volume**, Action - **Create**).



From the list of geometric primitives, select **Sphere**.

Set the following parameters:

- Radius: 50;

Click **Apply**.

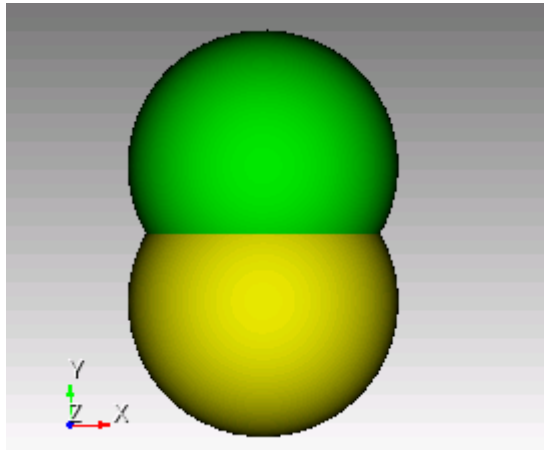

4. Move the second sphere.

On the command panel, select (Mode - **Geometry**, Entity - **Volume**, Action - **Transform**).

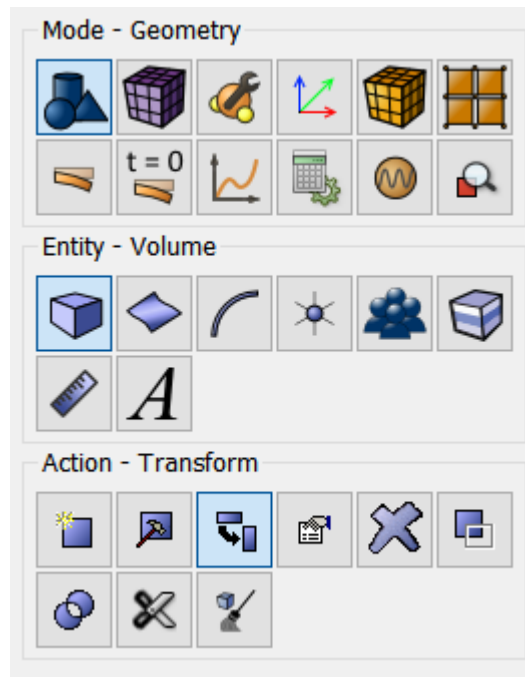

From the list, select **Move**.

Set the following parameters:

- Volume ID(s): 2;
- Include Merged;
- Select Method: Distance;
- Y Distance: -50

Click **Apply**.

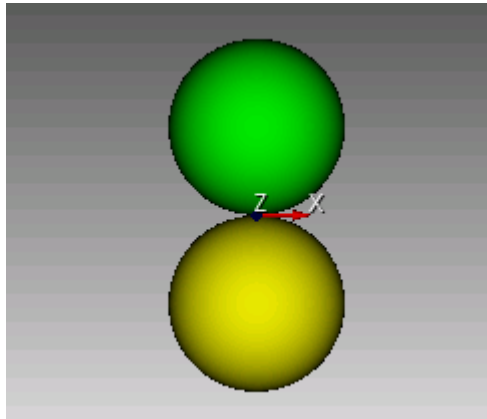

5. Cut the first sphere in two.

On the command panel, select geometry (Mode - **Geometry**, Entity - **Volume**, Action - **Webcut**).



Select from the list **Coordinate Plane**.

Set the following parameters:

- Volume ID(s): 1;
- Coordinate plane: ZX;
- Offset Value: 50;

Click **Apply**.

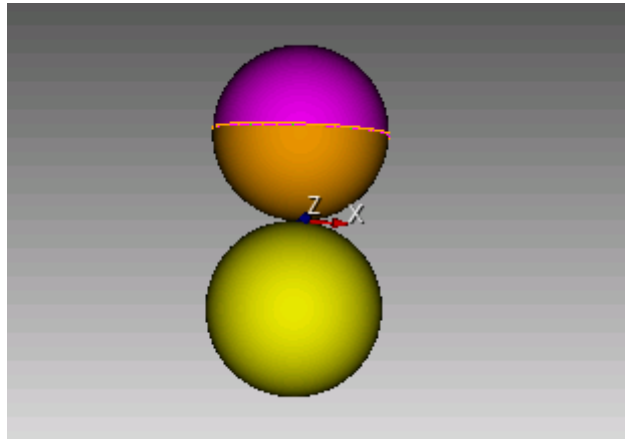

6. Cut the second sphere in two.

On the command panel, select geometry (Mode - **Geometry**, Entity - **Volume**, Action - **Webcut**).

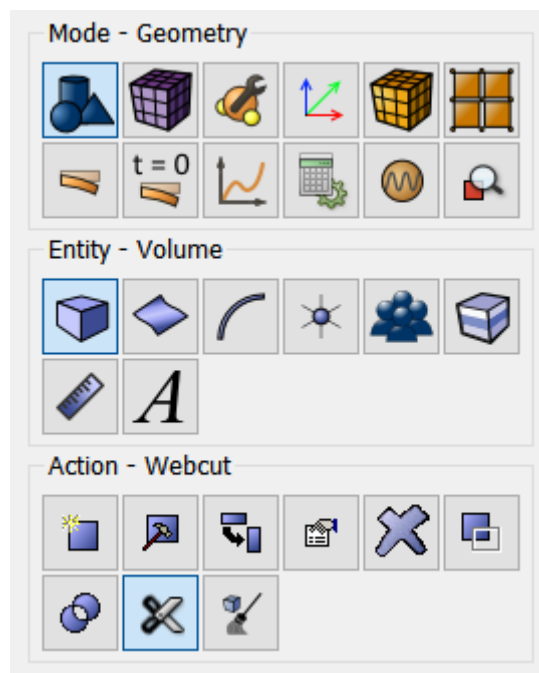

Select from the list **Coordinate Plane**.

Set the following parameters:

- Volume ID(s): 2;
- Coordinate plane: ZX;
- Offset Value: -50;

Click **Apply**.

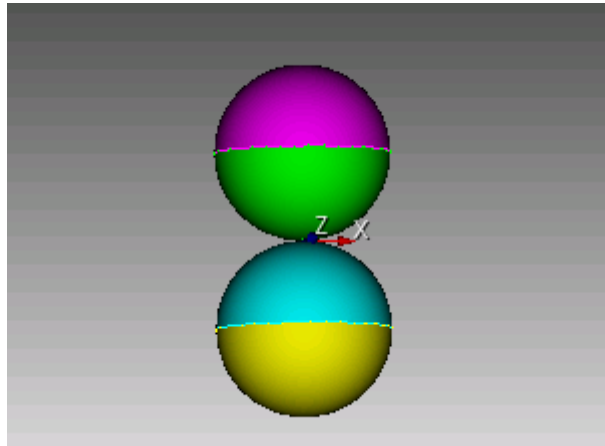

7.Delete the cut off parts of the spheres.

On the command panel, select geometry (Mode - **Geometry**, Entity - **Volume**, Action - **Delete**).

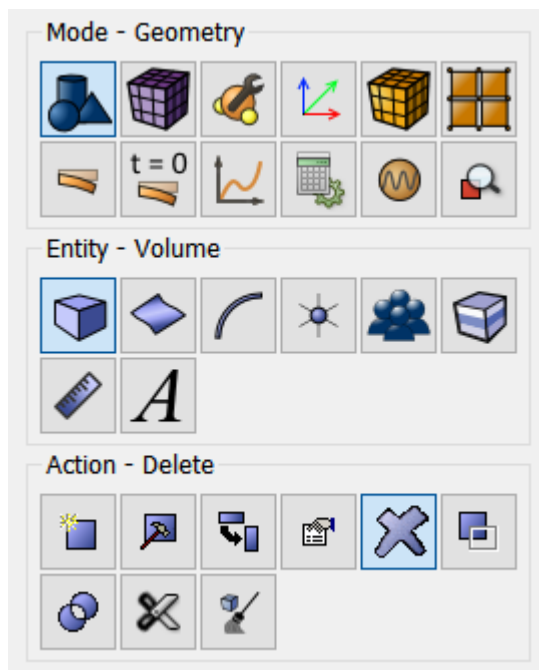

Set the following parameters:

- Volume ID(s): 2 3;

Click **Apply**.

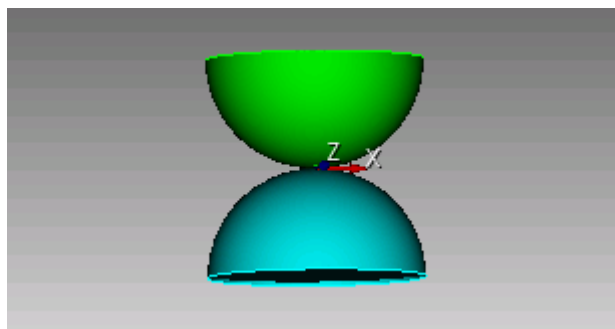

8. Cut the geometry in two.

On the command panel, select geometry (Mode - **Geometry**, Entity - **Volume**, Action - **Webcut**).

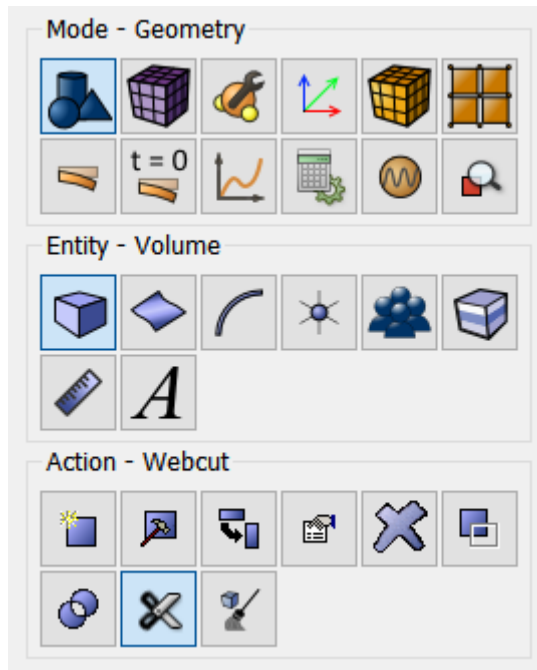

Select from the list **Coordinate Plane**.

Set the following parameters:

- Volume ID(s): all;
- YZ;

Click **Apply**.

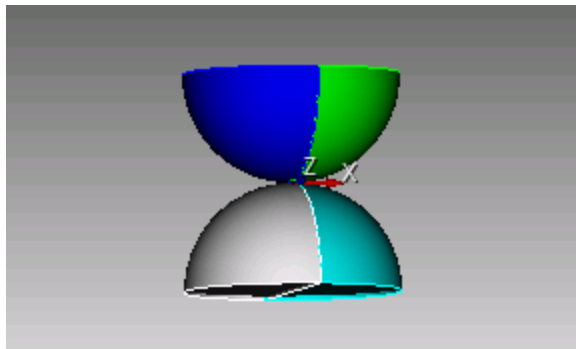

9. Cut the geometry in two.

On the command panel, select geometry (Mode - **Geometry**, Entity - **Volume**, Action - **Webcut**).

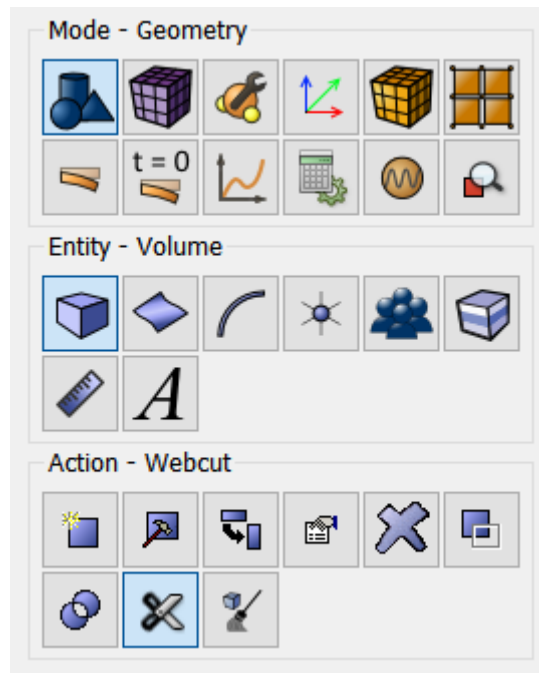

Select from the list **Coordinate Plane**.

Set the following parameters:

- Volume ID(s): all;
- XY;

Click **Apply**.

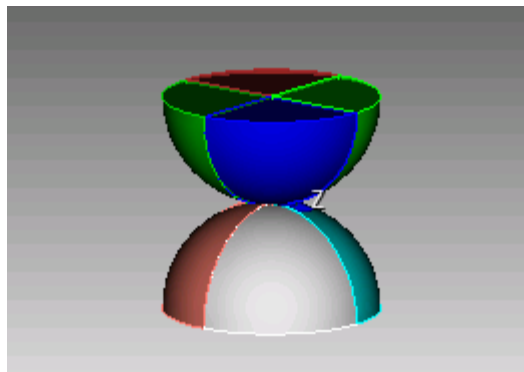

10.Remove parts of the spheres.

On the command panel, select geometry (Mode - **Geometry**, Entity - **Volume**, Action - **Delete**).

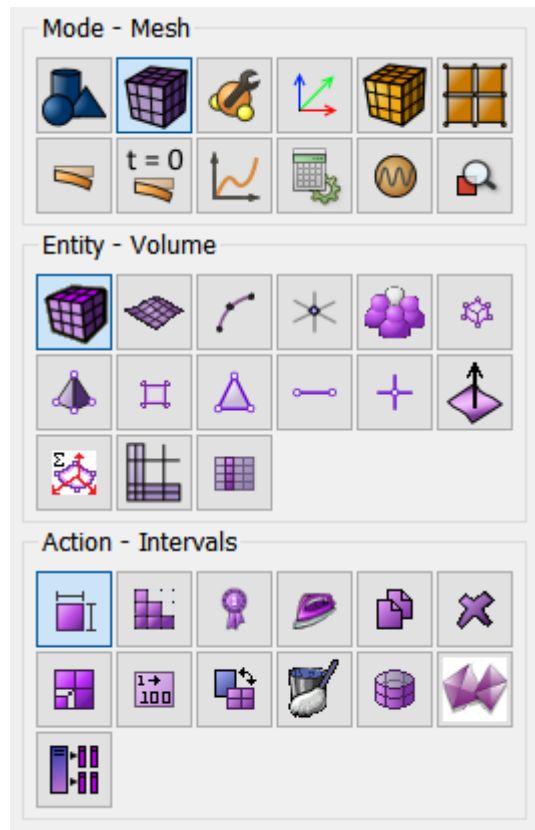

Select from the list **Automatic Sizing**.

- Select Volumes: 4.

Click **Apply Size**.

Click **Mesh**.

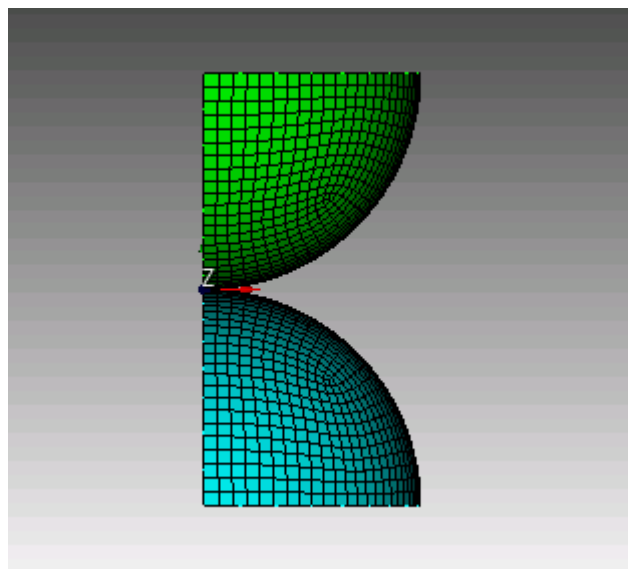

Specifying the material and Block

1. Set the first material. On the command panel, select (Mode — **Material**, Entity — **Materials Management**).

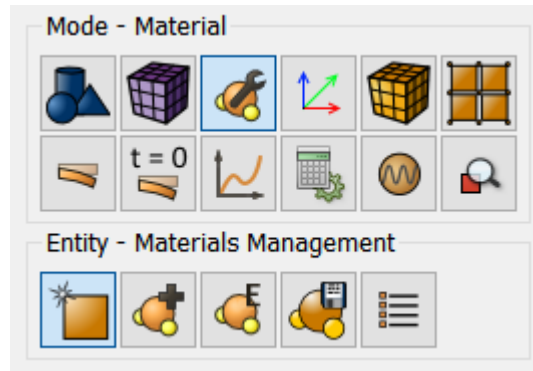

In the column "Material" enter the name of the material **Material 1**.

Click **Apply**.

In the column "Material properties" select the created material, then drag the desired properties to it from the left column.

Drag properties and specify their value:

- Young's Modulus: $2e+04$;
- Poisson Ratio: 0.3;

Click **Apply**.

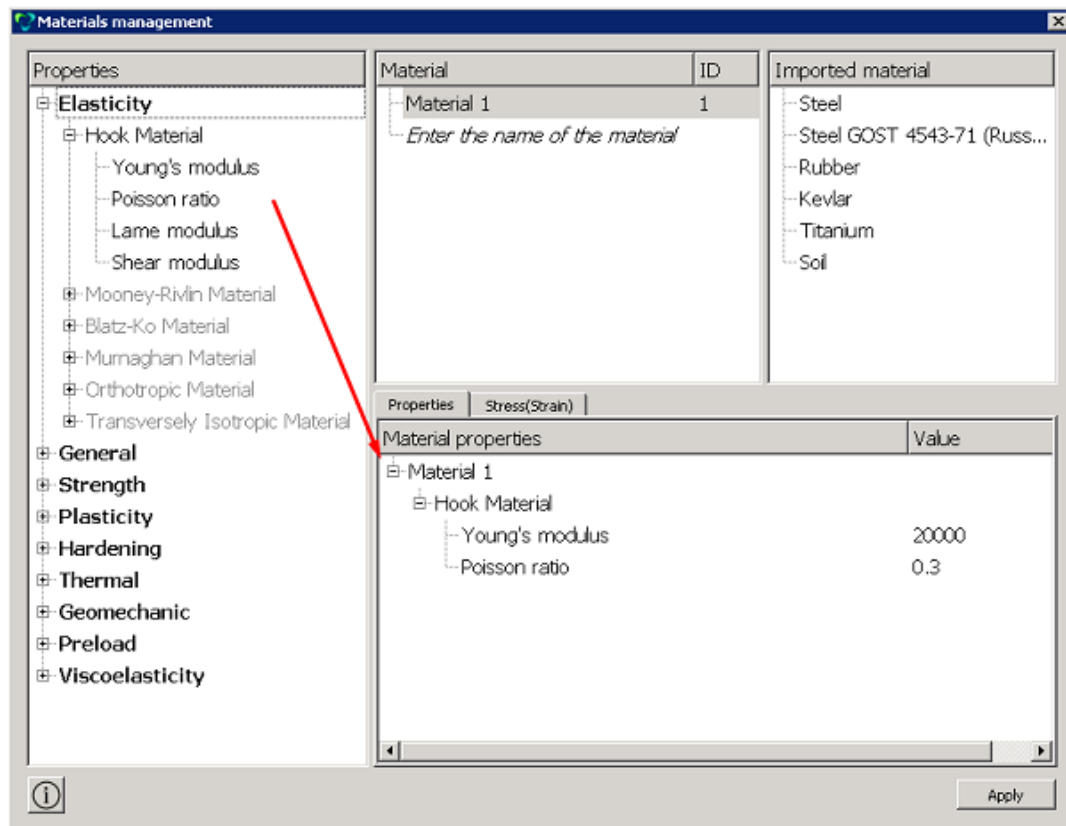

2. Create a block.

On the command panel, select (Mode — **Blocks**, Entity — **Block**, Action — **Add**).



- Entity List **Volume**;
- Entity ID: all.

Click **Apply**.

3.Set the block parameters.

On the command panel, select the mode for setting material properties (Mode - **Blocks**, Entity - **Block**, Action - **Block properties/parameters**).

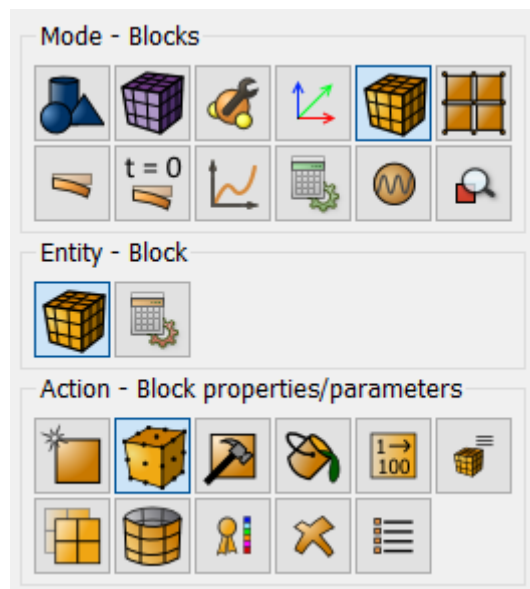

Set the following parameters:

- Block ID(s): 1;
- Available materials: Material 1;

- Coordinate System: Global Cartesian;
- Category: Solid;
- Order: 1.

Click **Apply**.

Setting boundary conditions

1. Fix the plate at X.

On the command panel select (Mode — **Boundary Conditions**, Entity — **Displacement**, Action — **Create**).

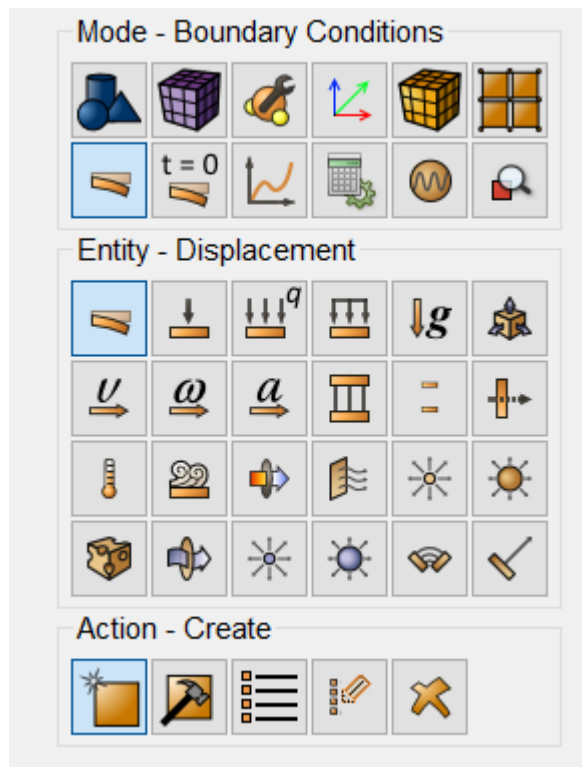

Set the following parameters:

- System Assigned ID;
- Entity List: Surface;
- Entity ID(s): 25 33;
- Degrees of Freedom: X-Translation Disp;
- DOF Value: 0.

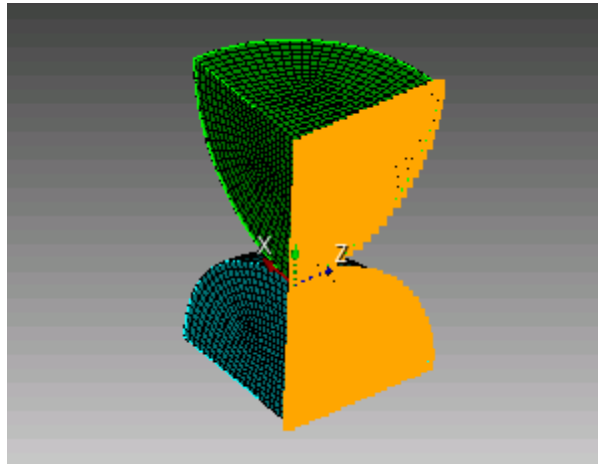

Click **Apply**.

2. Fix the plate at Z.

On the command panel select (Mode — **Boundary Conditions**, Entity — **Displacement**, Action — **Create**).

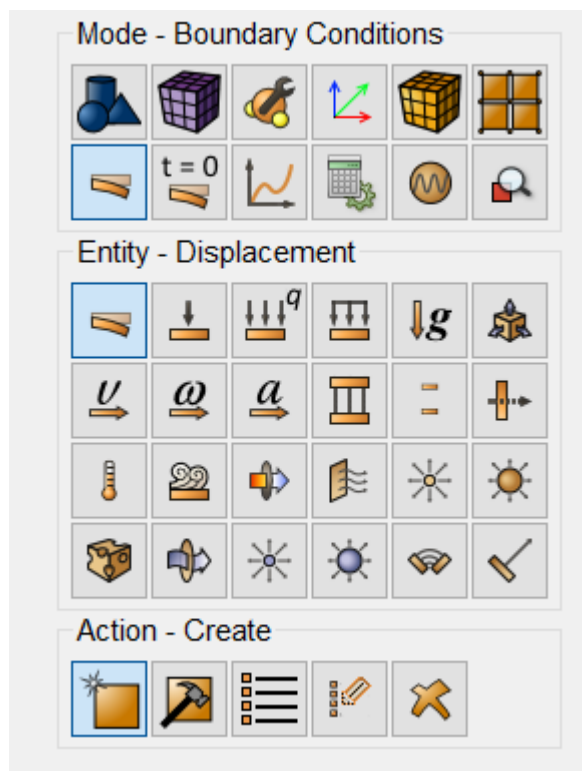

Set the following parameters:

- System Assigned ID;
- Entity List: Surface;
- Entity ID(s): 23 31;
- Degrees of Freedom: Z-Translation Disp;
- DOF Value: 0.

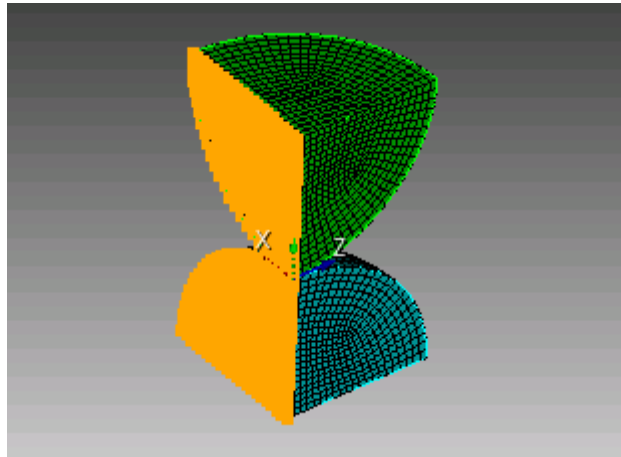

Click **Apply**.

3.Set displacement

On the command panel select (Mode — **Boundary Conditions**, Entity — **Displacement**, Action — **Create**).

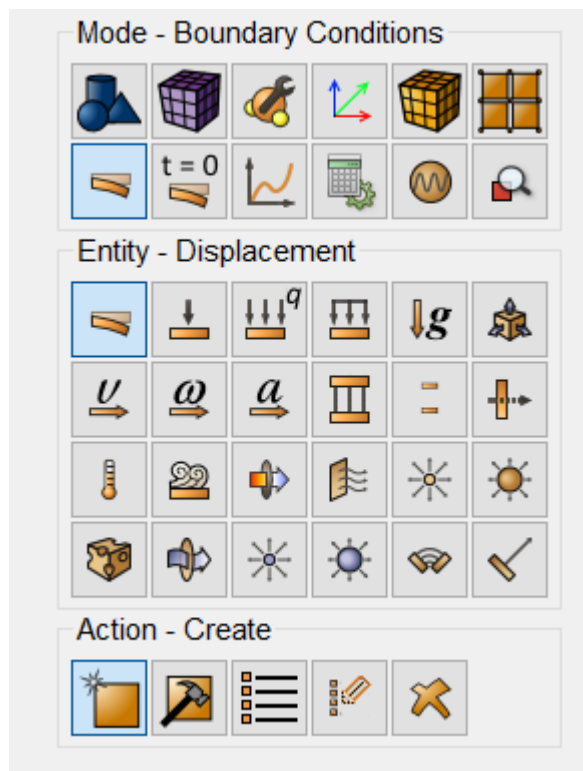

Set the following parameters:

- System Assigned ID;
- Entity List: Surface;
- Entity ID(s): 24;
- Degrees of Freedom: Y-Translation Disp;
- DOF Value: -2.

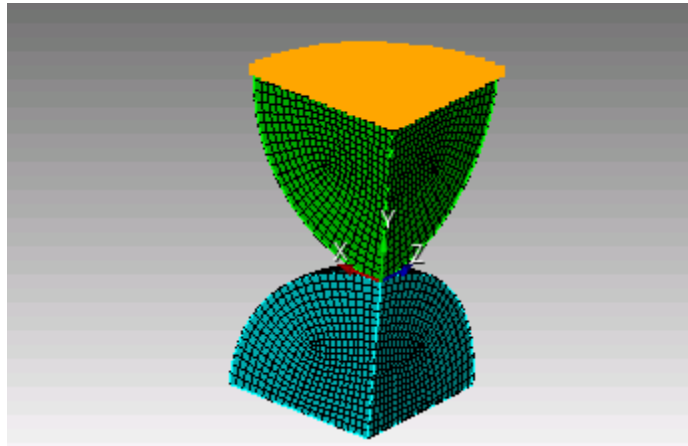

Click **Apply**.

4.Set displacement

On the command panel select (Mode — **Boundary Conditions**, Entity — **Displacement**, Action — **Create**).

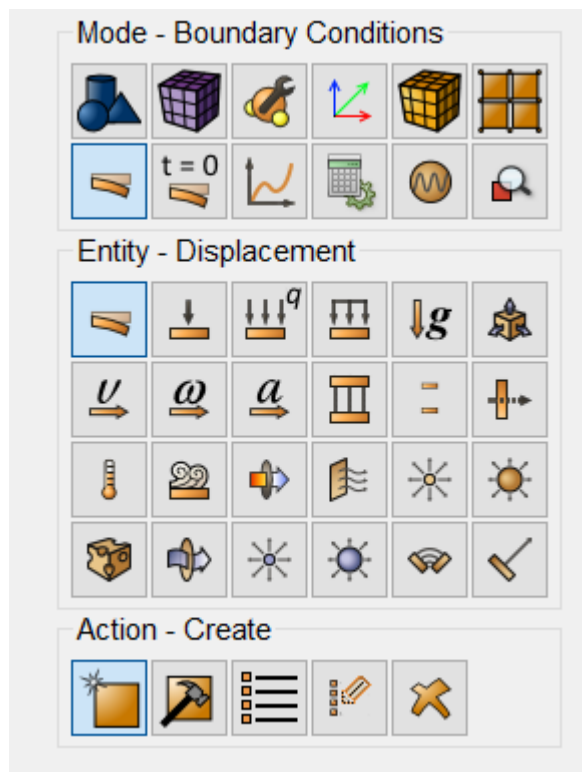

Set the following parameters:

- System Assigned ID;
- Entity List: Surface;
- Entity ID(s): 34;
- Degrees of Freedom: Y-Translation Disp;
- DOF Value: 2.

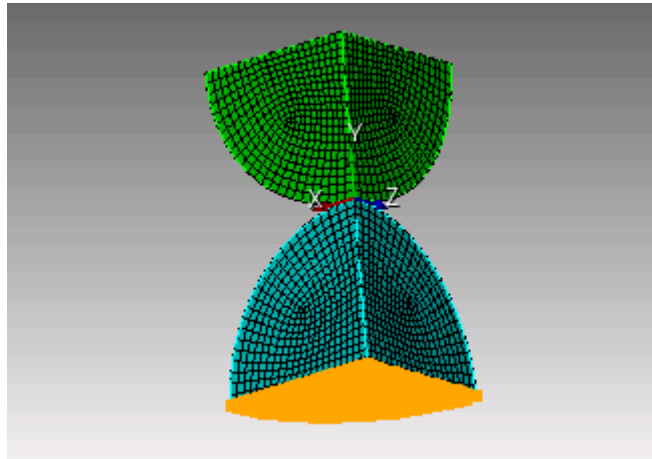

Click **Apply**.

5. Set the contact condition

On the command panel select (Mode — **Boundary Conditions**, Entity — **Contact**, Action — **Create**).

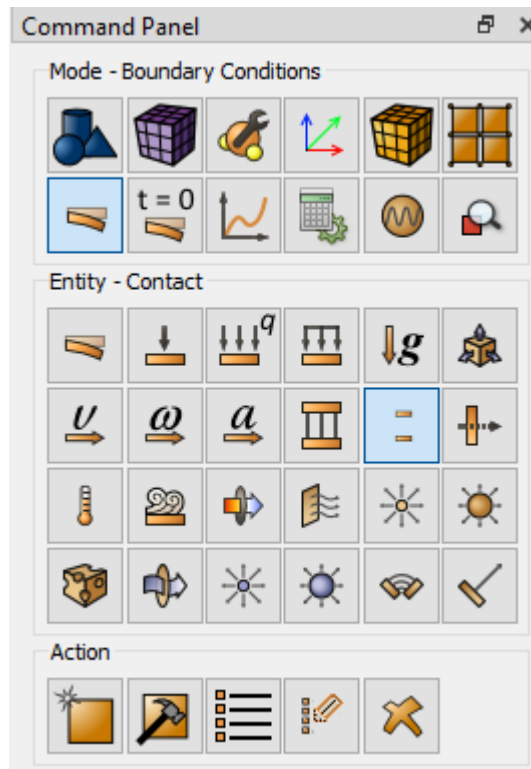

Set the following parameters:

- Master and Slave selection: Surface;
- Entity ID master entity: 32;
- Entity ID slave entity: 26;
- Tolerance: 0.0005;
- Type: General;

- Method: Auto.

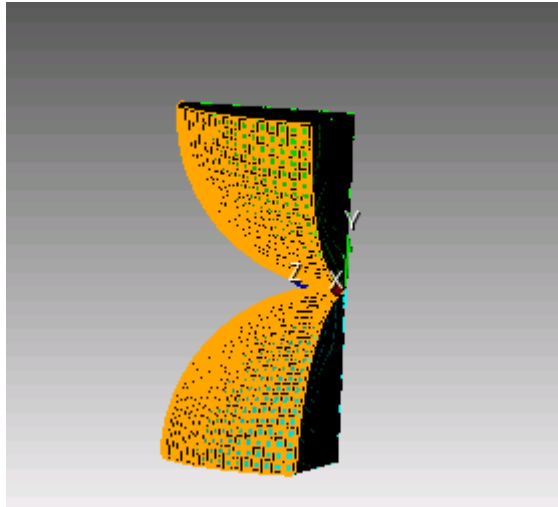

Click **Apply**.

Run calculation

1. Set the type of problem you want to solve.

On the command panel select the calculation settings module (Mode — **Calculation Settings**, Calculation Settings — **Static**, Static — **General**).

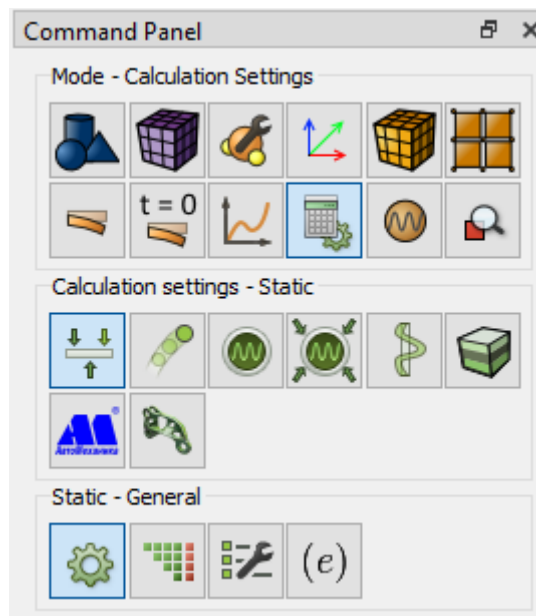

Please select:

- Dimension: 3D;
- Model: Elasticity;

Click **Apply**, Click **Start Calculation**.

2. In a pop-up window select a folder to save the result and enter the file name.

If the calculation is finished successfully, you will see a message in the Console: "Calculation finished successfully at "date time".

Results analysis

1. Open the file with the results.

You can do this in one of the three ways:

- Click Ctrl+E.
- Select Calculation Open Results in the Main Menu. Click **Open Results**.
- Select - **Results** on Command Panel (Mode - **Results**). Click **Open last result**.

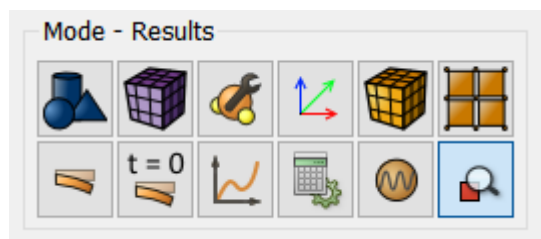

The **Fidesys Viewer** window will appear, in which you can view the calculation results.

2. On the top panel, select the data of the calculation result to display. From the first dropdown list select **Stress**, from the second – **YY**.

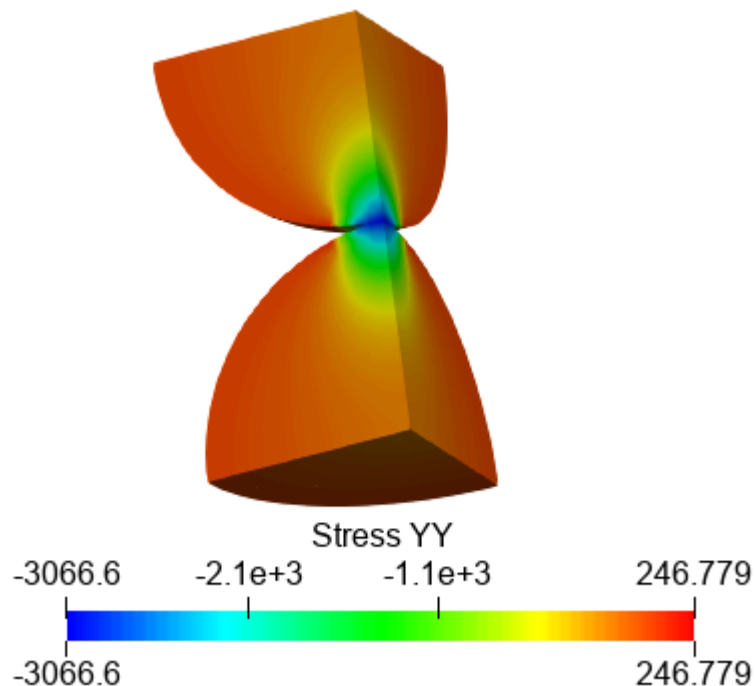

Using Console Interface

For geometry generation, meshing, setting boundary conditions and materials you can use Console Interface. For geometry generation, meshing, setting boundary conditions and materials you can use Console Interface.



It is also possible to run the *Hertz_problem.jou* by selecting Journal Editor on Toolbar. In a pop-up window of the main menu select **File** → **Open** and open the necessary journal file.

Calculation of the dynamic problem of plates with contact

We consider the problem of an elastic strip that moves from the initial speed and crashes into a hard wall. During interaction, the strip is in contact with the wall (sliding contact without friction).

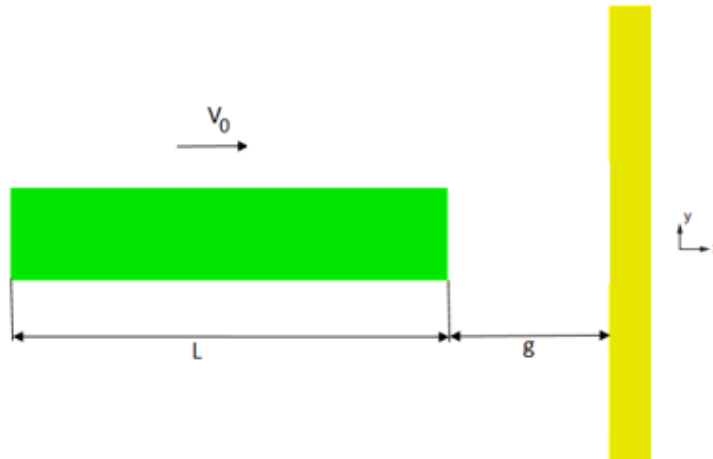

Geometry Creation

1. Create a rectangle.

Select surface geometry generation section on Command Panel (Mode — **Geometry**, Entity — **Surface**, Action — **Create**).

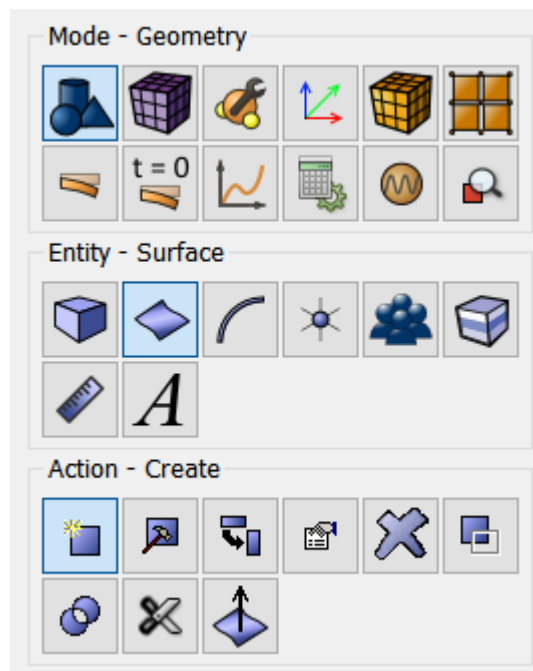

From the list of geometric primitives, select **Rectangle**.

Set the following parameters:

- Width: 10;
- Height: 1;
- ZPlane.

Click **Apply**.

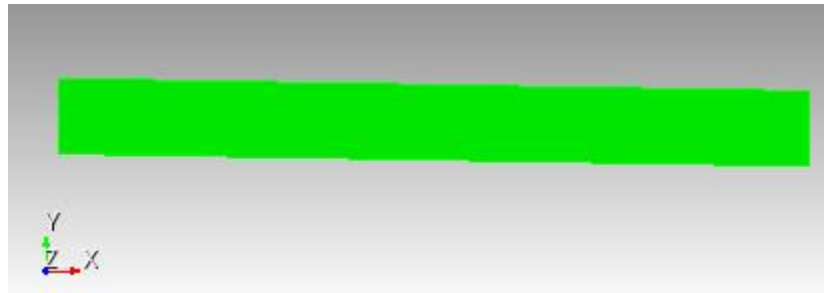

2. Create a vertical rectangle.

Select surface geometry generation section on Command Panel (Mode — **Geometry**, Entity — **Surface**, Action — **Create**).

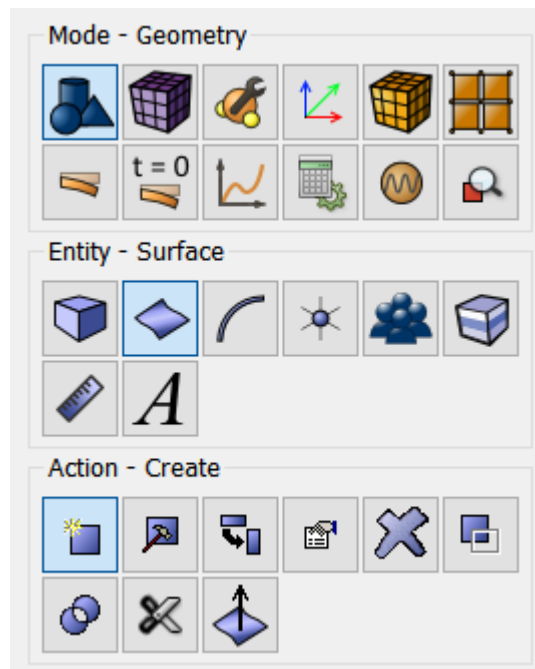

From the list of geometric primitives, select **Rectangle**.

Set the following parameters:

- Width: 1;
- Height: 5;
- ZPlane.

Click **Apply**.

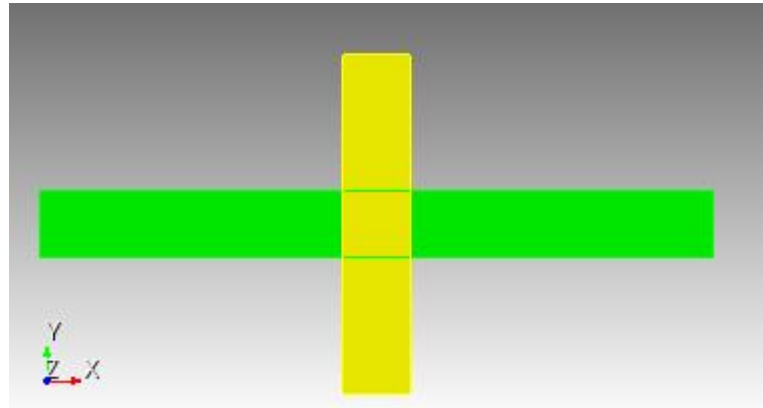

3. Move the vertical rectangle.

On the command panel, select: (Mode — **Geometry**, Entity — **Surface**, Action — **Transform**).

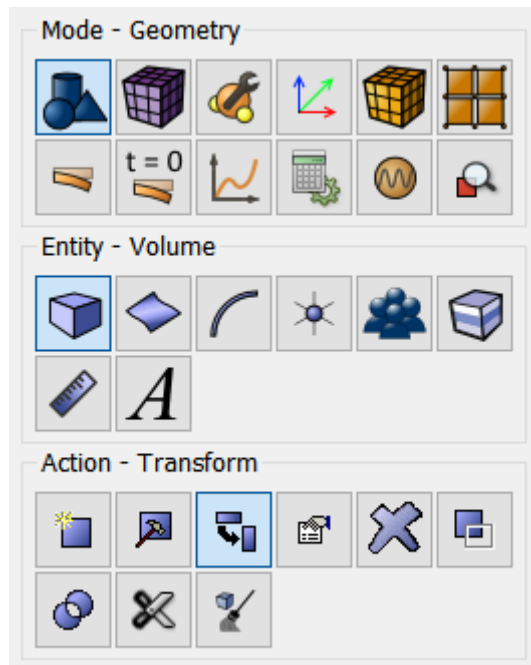

From the list of actions, select **Move**.

Set the following parameters:

- Surface ID(s): 2;
- Include Merged;
- X Distance: 5.51.

Click **Apply**.

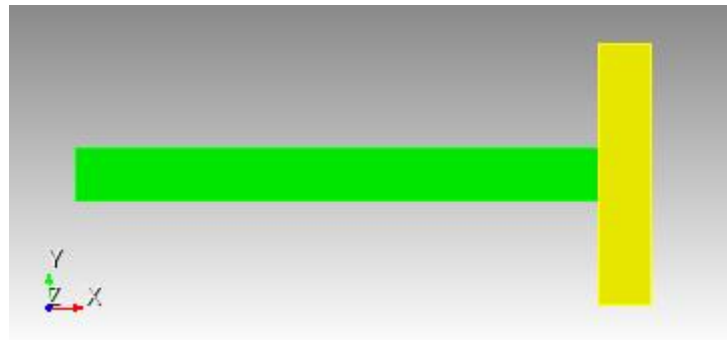

Meshing

1. Create a mesh.

On the command panel, select (Mode — **Mesh**, Entity — **Surface**, Action — **Intervals**).

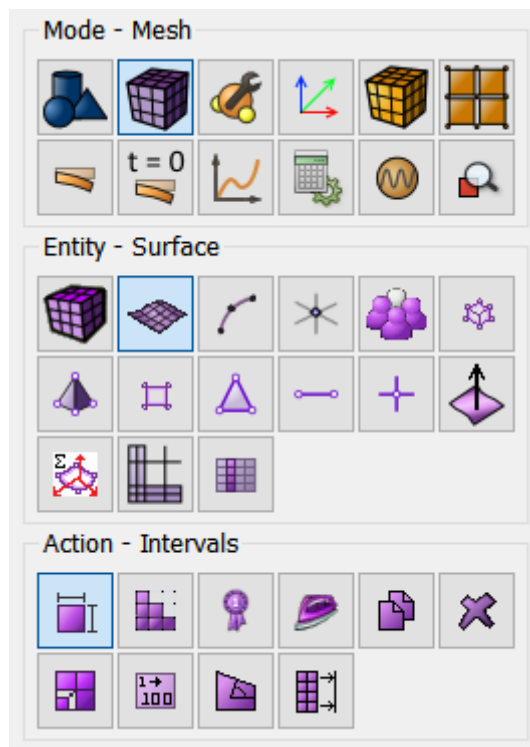

From the list of actions, select **Automatic Sizing**

- Select Volumes: all;
- Auto Factor: 7

Click **Apply Size, Mesh**.

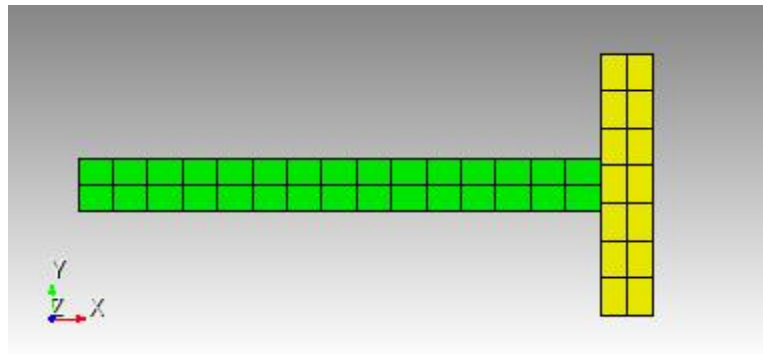

Specifying the material and Block

1. Set the first material.

On the command panel, select (Mode — **Material**, Entity — **Materials Management**).

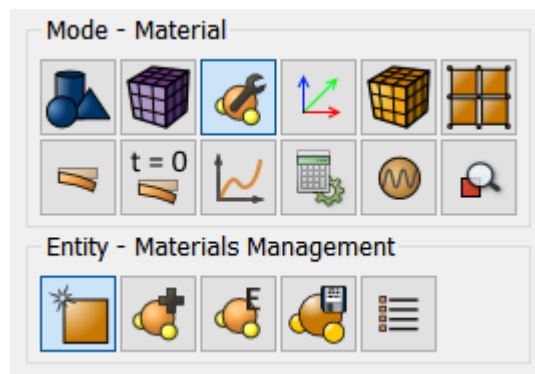

In the column "Material" enter the name of the material **Mat1**.

In the column "Material properties" select the created material, then drag the desired properties to it from the left column.

Drag properties and specify their value:

- Young's Modulus: $3e+07$;
- Poisson Ratio: 0.3;
- Density: $0.73e-3$;

Click **Apply**.

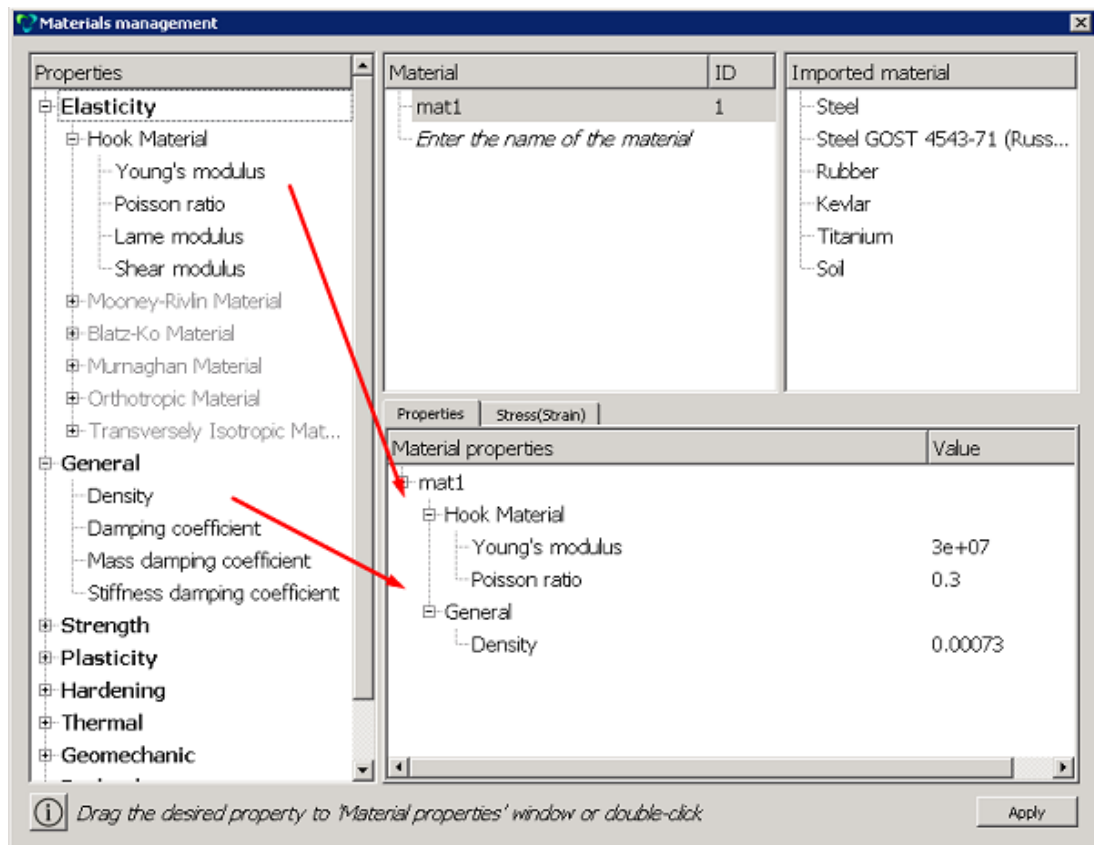

2. Create a block.

On the command panel, select (Mode — **Blocks**, Entity — **Block**, Action — **Add**).



- Entity List **Surface**;
- Entity ID: all.

Click **Apply**.

3.Set the block parameters.

On the command panel, select the mode for setting material properties (Mode - **Blocks**, Entity - **Block**, Action - **Block properties/parameters**).

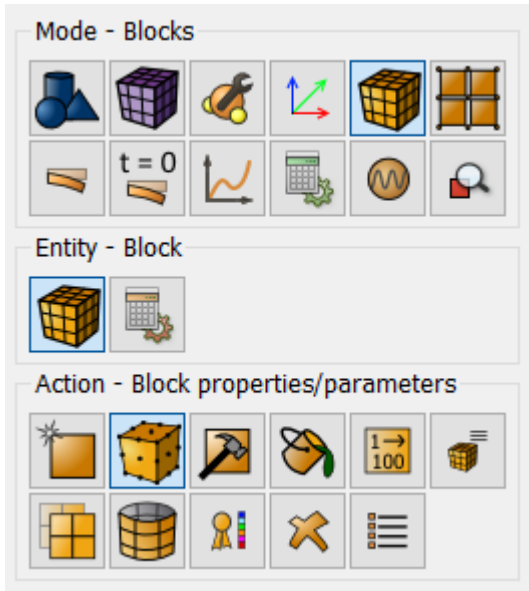

Set the following parameters:

- Block ID(s): 1;
- Available materials: Mat1;
- Coordinate System: Global Cartesian;
- Category: Plane;
- Order: 2.

Click **Apply**.

Setting boundary conditions

1.Fix the horizontal plate at Y and Z directions.

On the command panel select (Mode — **Boundary Conditions**, Entity — **Displacement**, Action — **Create**).

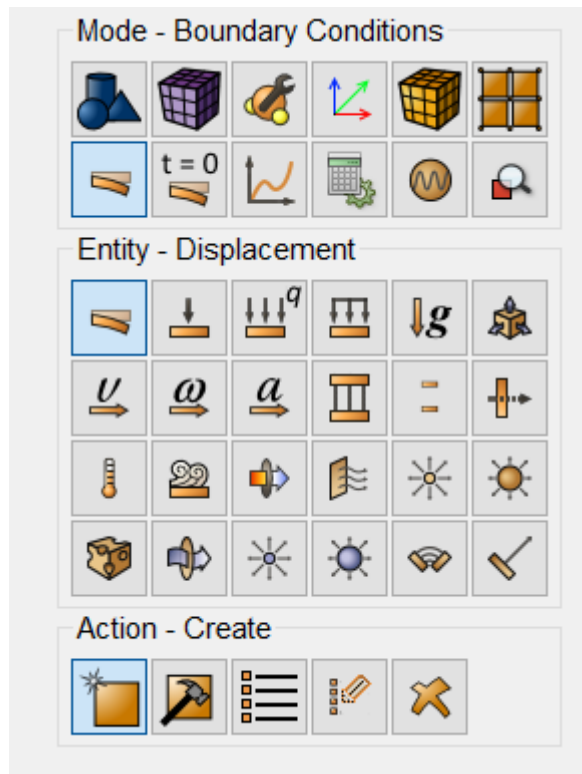

Set the following parameters:

- System Assigned ID;
- Entity List: Surface;
- Entity ID(s): 1;
- Degrees of Freedom: Y-Translation Disp, Z-Translation Disp;
- DOF Value: 0.

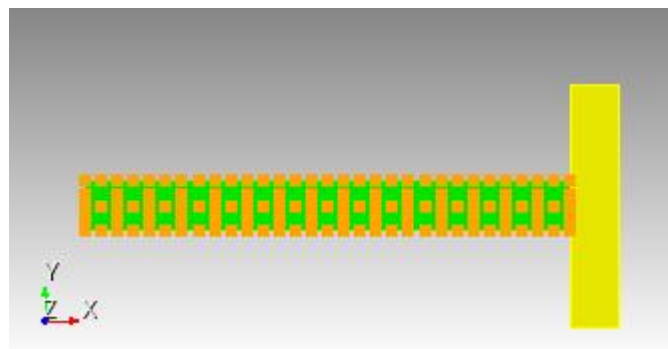

Click **Apply**.

2. Fix the vertical plate at all directions.

On the command panel select (Mode — **Boundary Conditions**, Entity — **Displacement**, Action — **Create**).

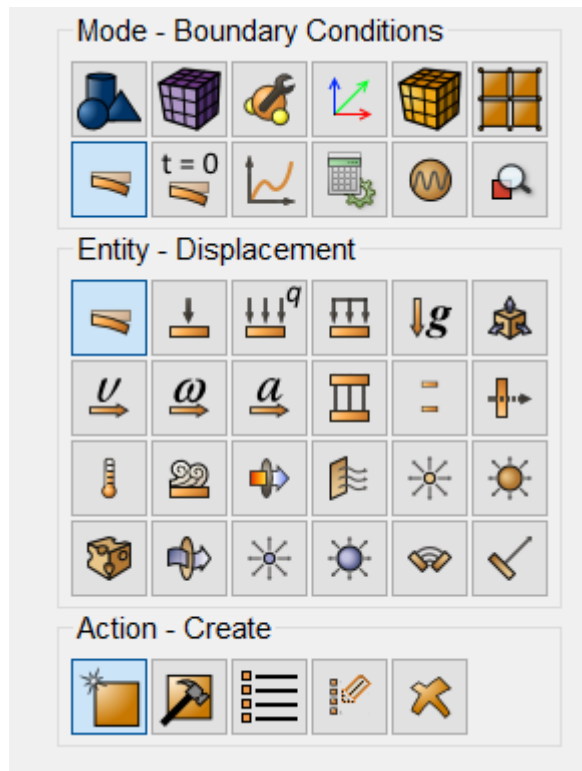

Set the following parameters:

- System Assigned ID;
- Entity List: Surface;
- Entity ID(s): 1;
- degrees of Freedom: All;
- DOF Value: 0.



Click **Apply**.

3. Set the contact condition

On the command panel select (Mode — **Boundary Conditions**, Entity — **Contact**, Action — **Create**).

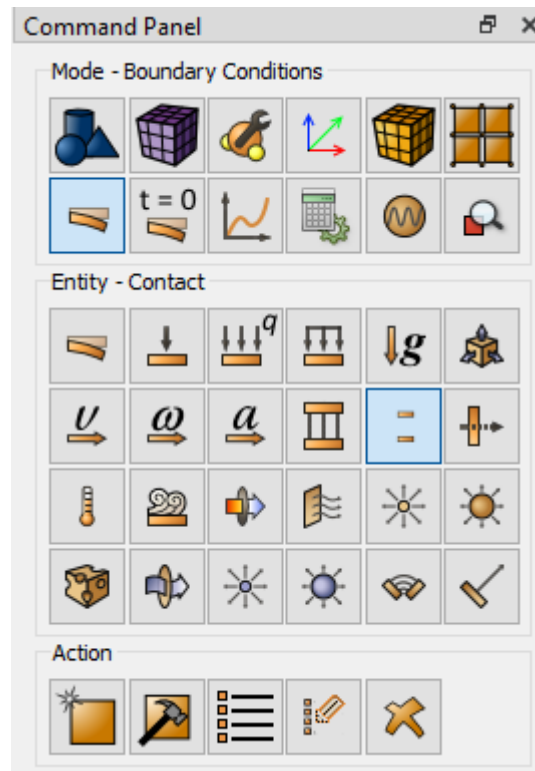

Set the following parameters:

- Master and Slave selection: Curve;
- Entity ID master entity: 6;
- Entity ID slave entity: 4;
- Tolerance: 0.0005;
- Type: General;
- Method: Penalty;
- Normal Stiffness: 0.5;
- Tangent Stiffness: 0.5.

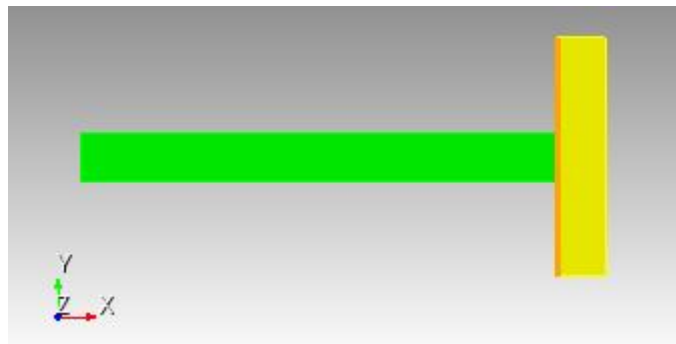

Click **Apply**.

Setting initial conditions

1. Apply initial velocity to the first plate.

On the command panel select (Mode — **Initial Conditions**, Entity — **Velocity**, Action — **Create**).

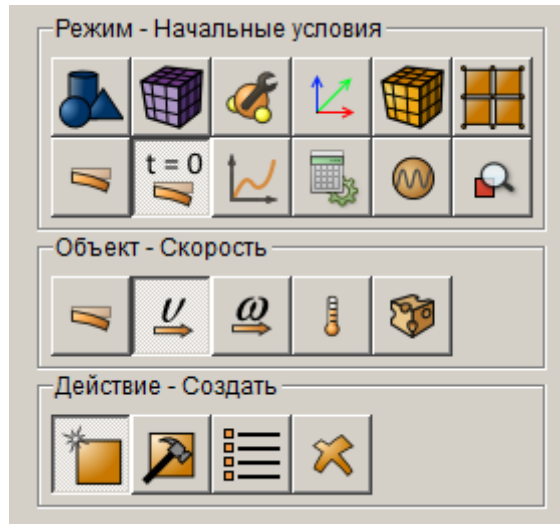

Set the following parameters:

- Surface;
- Entity ID(s): 1;
- X Velocity: 202.2;



Click **Apply**.

Run calculation

1. Set the type of problem you want to solve.

On the command panel select the calculation settings module (Mode — **Calculation Settings**, Calculation Settings — **Transient analysis**, Transient analysis — **General**).

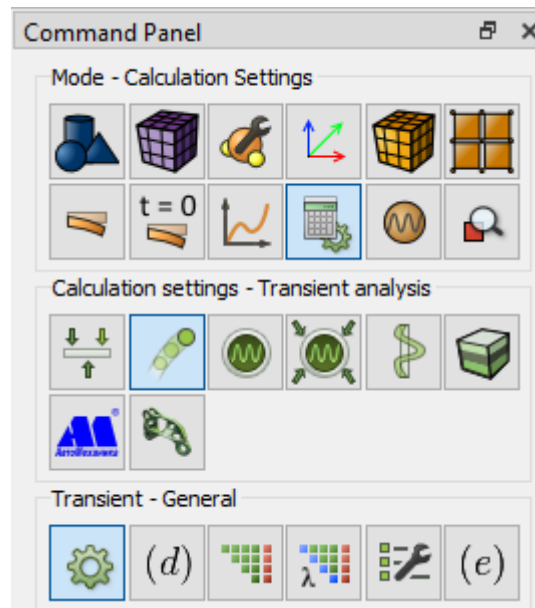

Please select:

- Dimension: 2D;
- Plane strain;
- Scheme: Implicit;
- Max time: 0.00016;
- Steps count: 1000;
- Preload model: remove the flag;
- Implicit scheme options: Newmark algorithm gamma: 0;

Click **Apply**.

2. Configure additional settings.

On the command panel select the calculation settings module (Mode — **Calculation Settings**, Calculation Settings — **Transient analysis**, Transient analysis — **Output Fields**).

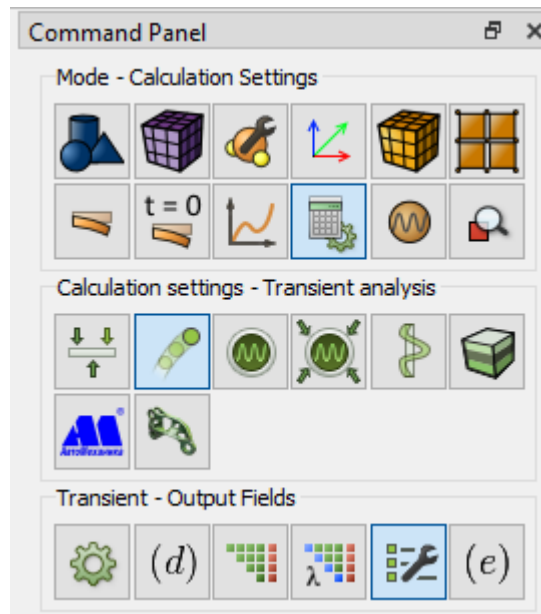

Please select:

- Calculate kinetic and deformation energies;

Click **Apply**, Click **Start Calculation**.

3. In a pop-up window select a folder to save the result and enter the file name.

If the calculation is finished successfully, you will see a message in the Console: "Calculation finished successfully at "date time".

Results analysis

1. Open the file with the results.

You can do this in one of the three ways:

- Click Ctrl+E.
- Select Calculation Open Results in the Main Menu. Click **Open Results**.
- Select - **Results** on Command Panel (Mode - **Results**). Click **Open last result**.

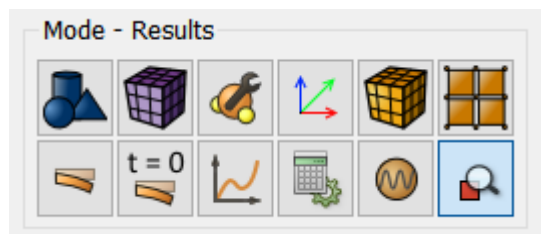

The **Fidesys Viewer** window will appear, in which you can view the calculation results.

2. On the main panel Fidesys Viewer click **Select Points On (d)**



Select a point with coordinates on the geometric model (5 0 0).

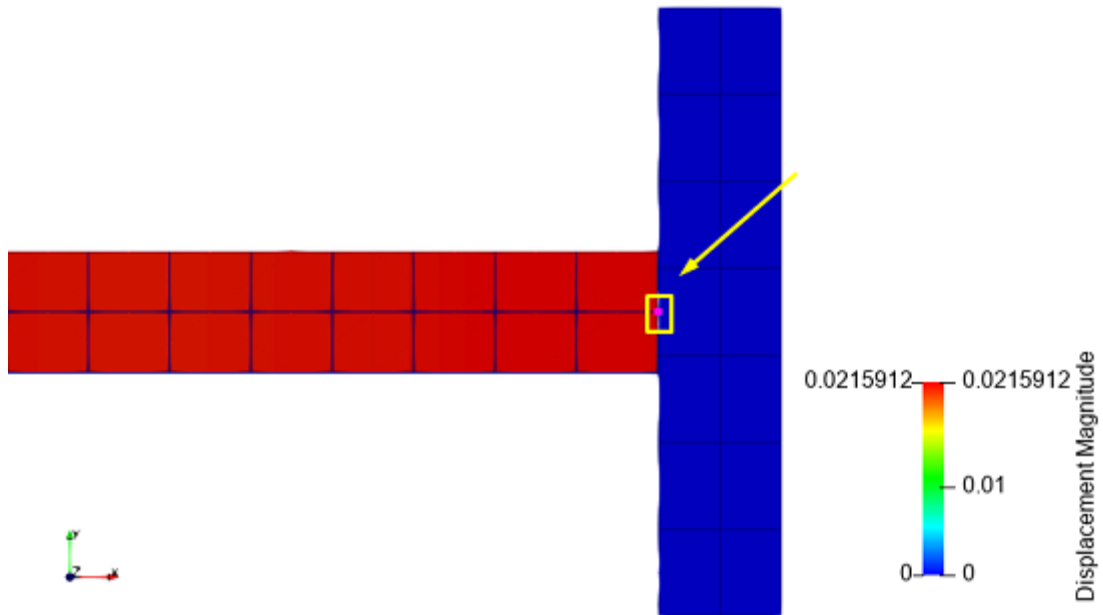

From the main menu select **Filters - Alphabetical - Plot Selection Over Time**.

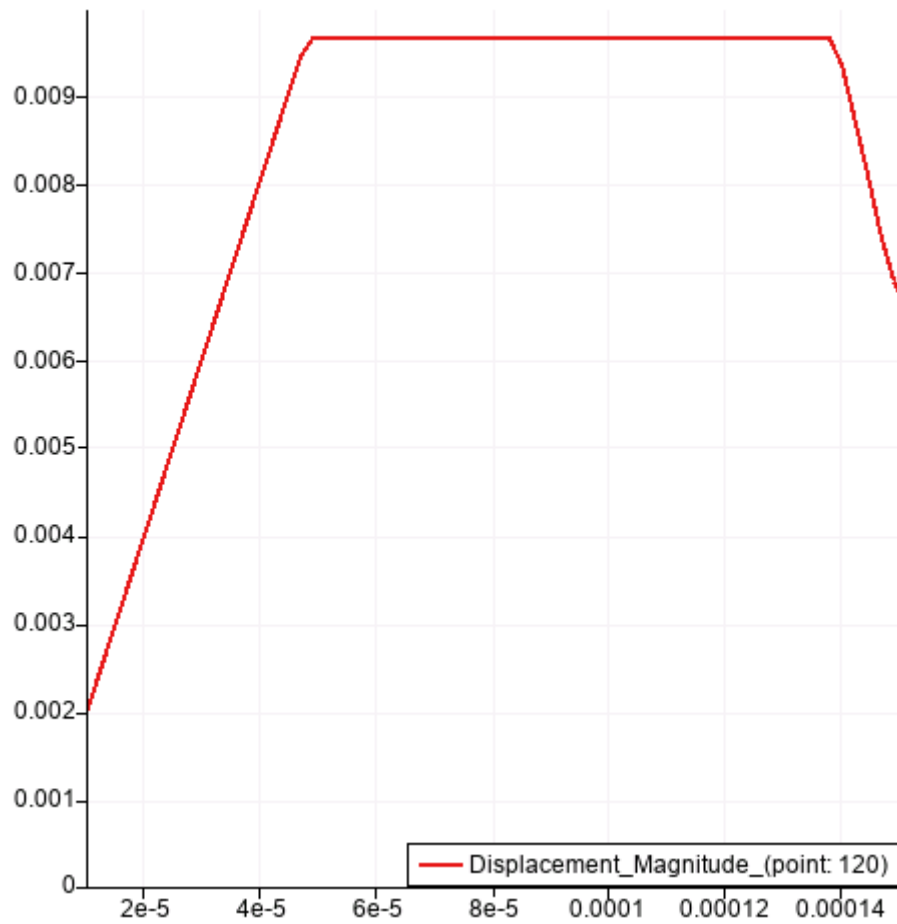

Using Console Interface

For geometry generation, meshing, setting boundary conditions and materials you can use Console Interface. For geometry generation, meshing, setting boundary conditions and materials you can use Console Interface.



It is also possible to run the *dyn_contact_penalty.jou* by selecting Journal Editor on Toolbar. In a pop-up window of the main menu select **File** → **Open** and open the necessary journal file.

Optimization Problem With Fidesys Python API

To carry out the optimization calculation, it is necessary that the following conditions are met:

- Installed Python v.3.8 or higher;
- Installed vtk library for Python;
- Installed numpy library for Python.

To meet these conditions, you must do the following:

- Download Python 3.8 or higher from python.org and install.
- Open the Windows command line (cmd.exe) and write:
pip3 install numpy (then press Enter and let the installation complete);
pip3 install vtk (then press Enter and let the installation complete).

After all the necessary steps have been completed, you can start solving the problem.

The problem of optimization of the diameter of the base of a billboard pillar, loaded with a wind load, is considered.

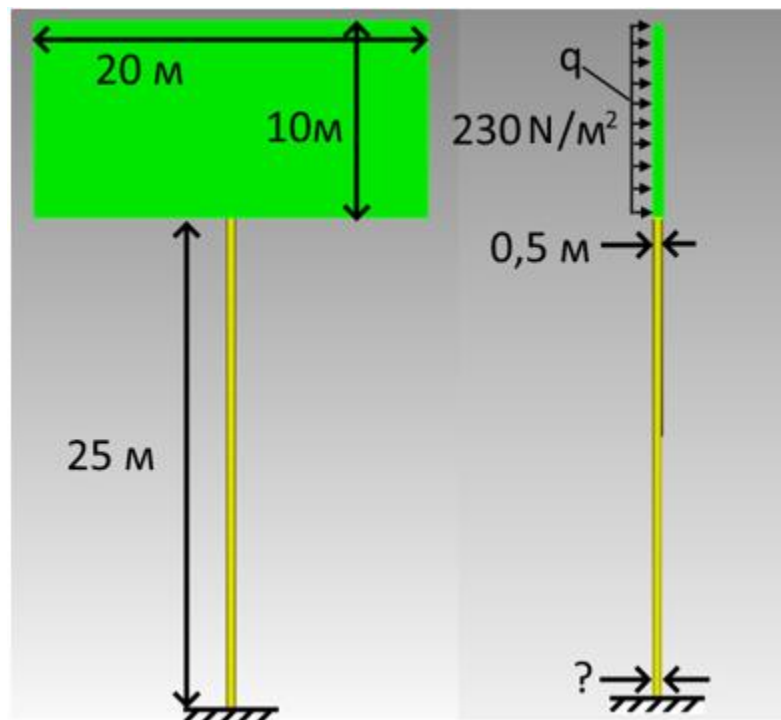

Geometry Creating

1. Create a brick.

Select volume geometry generation section on Command Panel (Mode — **Geometry**, Entity — **Volume**, Action — **Create**).



From the list of geometric primitives, select **Brick**.

Set the following parameters:

- X (width): **20**;
- Y (height): **0.5**;
- Z (depth): **10**;

Click **Apply**.

Then the volume needs to be moved.

Go to (Mode — **Geometry**, Entity — **Volume**, Action — **Transform**).

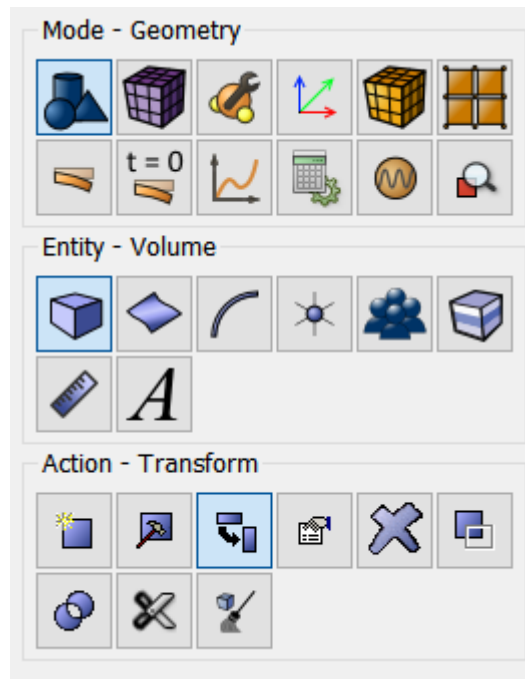

Select **Move** from the list of operations.

Set the following parameters:

- Volume ID's: **1**;
- Method: **Distance**
- X Distance: **0**;
- Y Distance: **0**;
- Z Distance: **30**.

Click **Apply**.

2. Create a frusto-cone pillar.

Go to (Mode — **Geometry**, Entity — **Volume**, Action — **Create**).

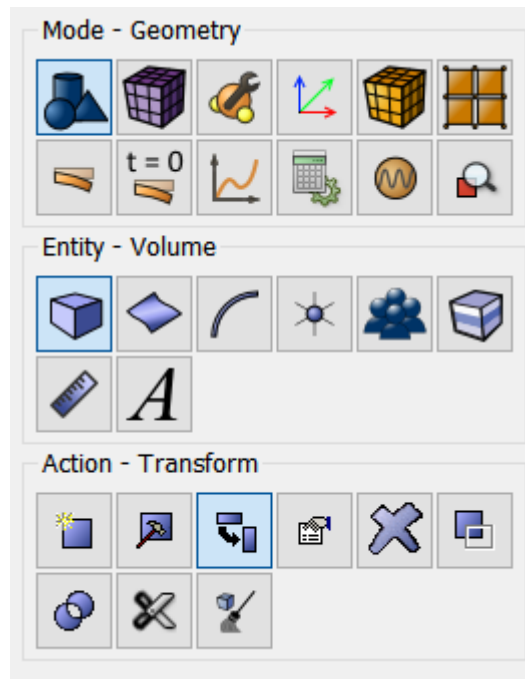

Select **Move** from the list of operations.

Set the following parameters:

- Volume ID's: **2**;
- Method: **Distance** ;
- X Distance: **0**;
- Y Distance: **0**;
- Z Distance: **12.5**.

Click **Apply**.

3. Create common surfaces to generate the correct mesh.

Go to (Mode — **Geometry**, Entity — **Volume**, Action — **Imprint and Merge**).



Select **Imprint/Merge Volumes** from the list of operations.

Set the following parameters:

- Volume ID's: **all**

Click **Apply**.

Meshing

1. Create a mesh.

Go to (Mode — **Mesh**, Entity — **Volume**, Action — **Mesh**).

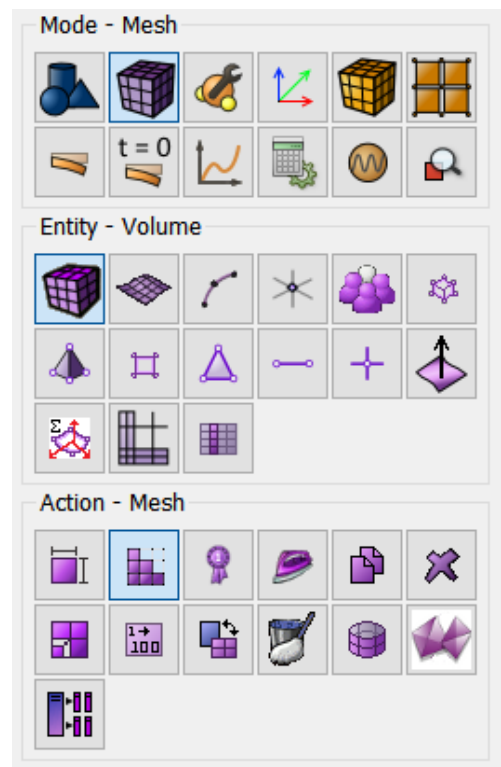

Select **Tetmesh** from the list of algorithms.

Set the following parameters:

- Select volumes: **all**

Click **Mesh**.

If everything was done correctly, you will see a model like this:

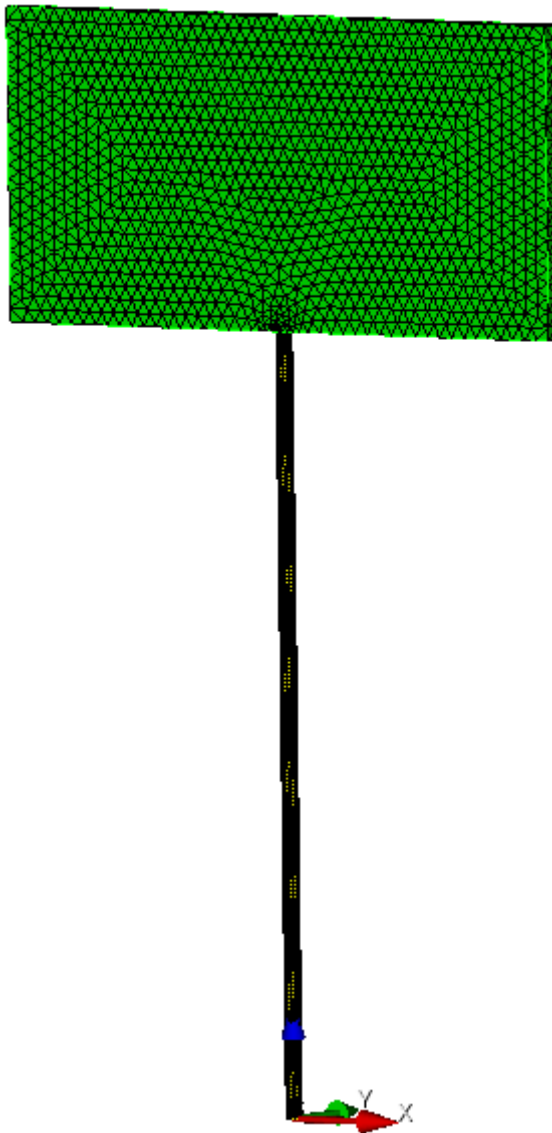

Specifying the material

1. Create the material.

Go to (Mode — **Material**, Entity — **Materials Management**).

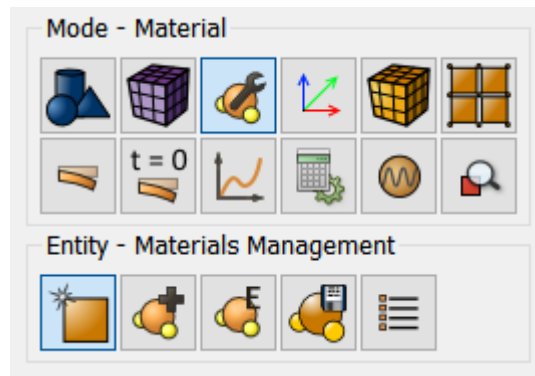

In the Material Management window, drag&drop "Steel" from the third column to the second.

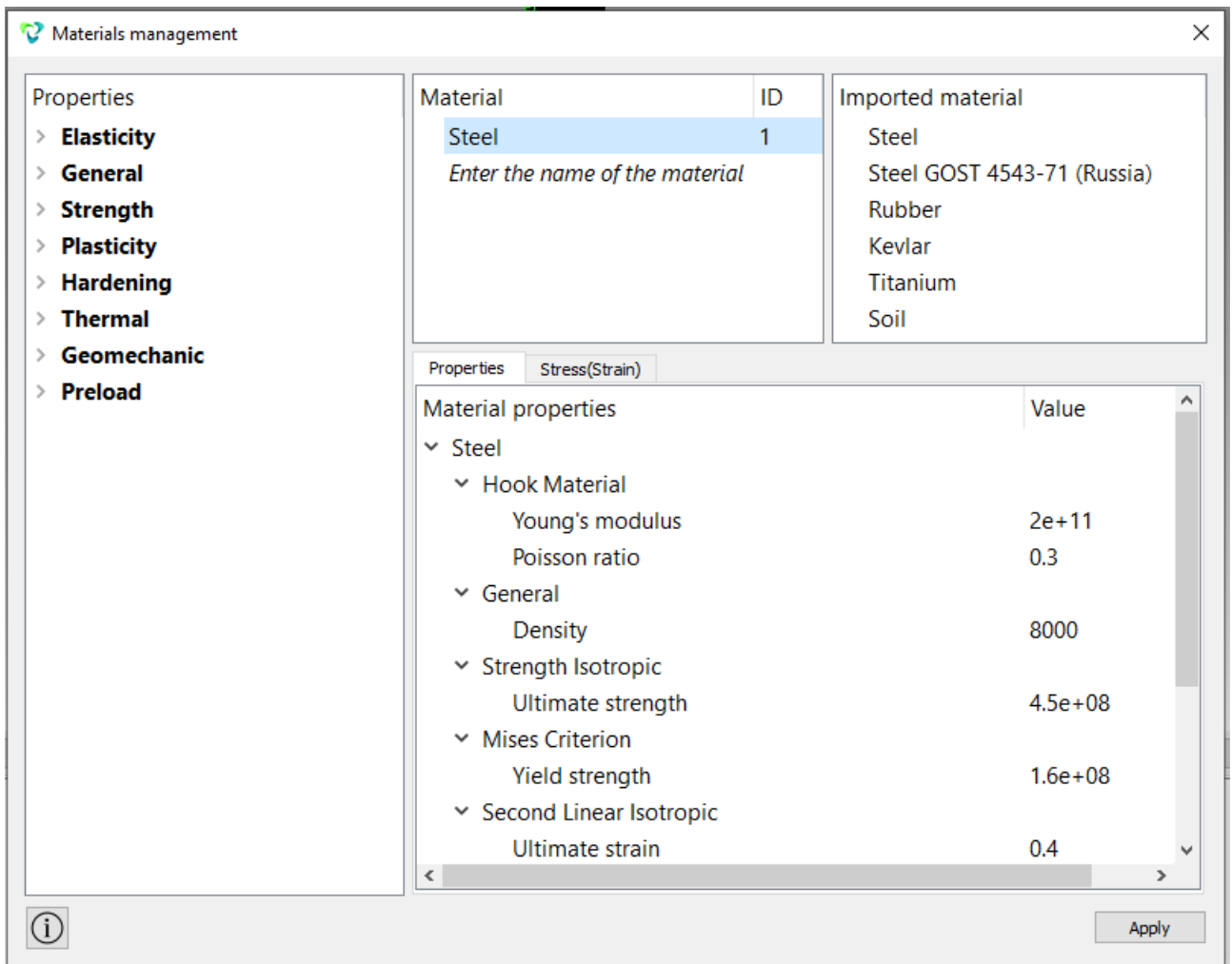

Click **Apply**.

2. Create a block

Go to (Mode — **Blocks**, Entity — **Block**, Action — **Add**).

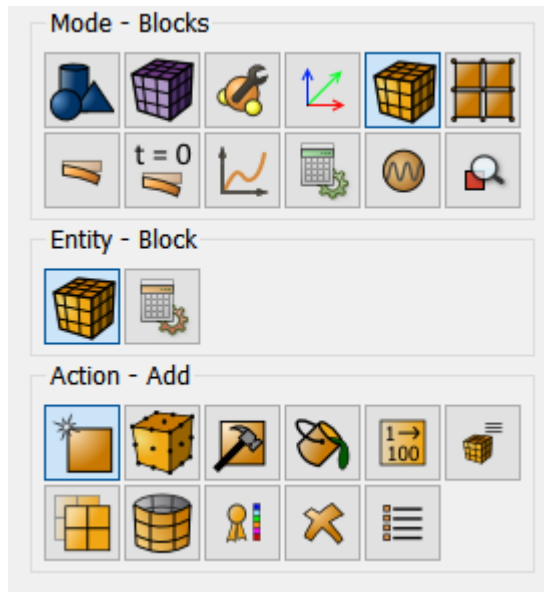

Select **Volume** in the Entity List.

Set the following parameters:

- Entity ID's: **all**

Click **Apply**.

3. Set the block properties

Go to (Mode — **Blocks**, Entity — **Block**, Action — **Block properties/parameters**).

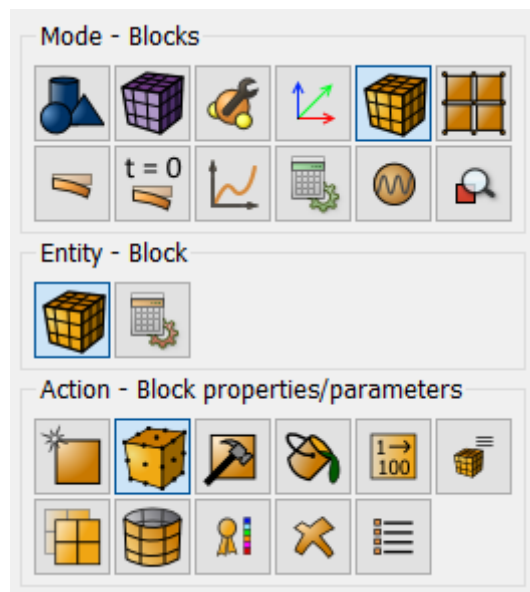

Set the following parameters:

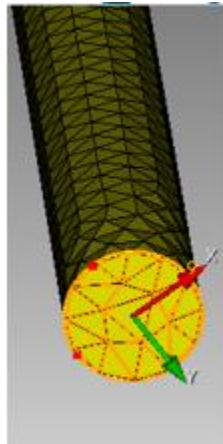

2. Set the distributed wind force on the billboard surface to $p = 230 \text{ N/m}^2$.

Go to (Mode — **Boundary Conditions**, Entity — **Distributed force**, Action — **Create**).

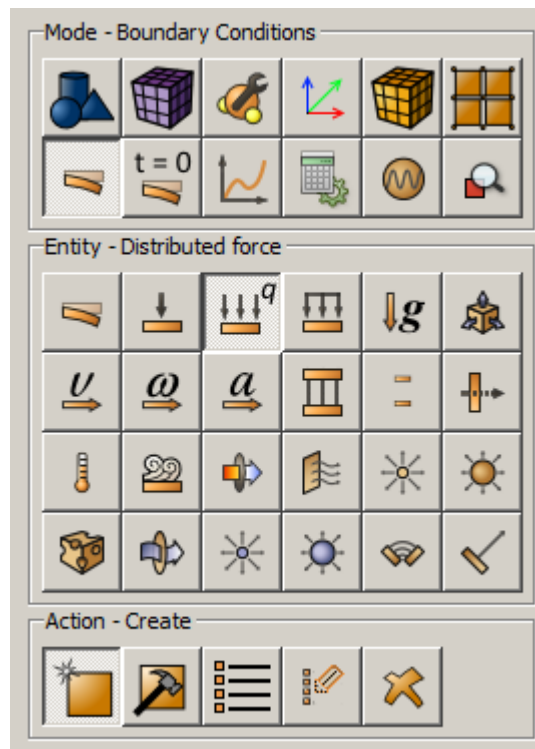

Select **Surface** from the Entity List.

Set the following parameters:

- Entity ID(s): **3**;
- Force type: **Distributed Force**;
- Force: **230**;
- Direction Vector: (**X: 0, Y: 1, Z: 0**).

Click **Apply**.

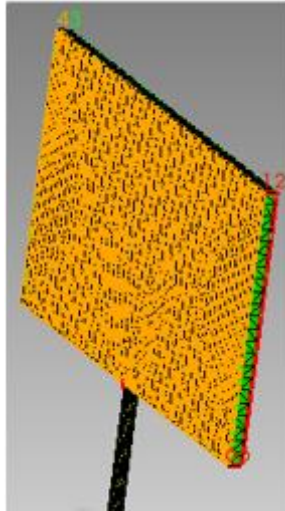

3. Add gravity

Go to (Mode — **Boundary Conditions**, Entity — **Gravity**, Action — **Create**).



Select **Global** from the Entity List.

Set the following parameters:

- Directions: Z **-9.81**.

Click **Apply**.

Preparing for calculation

1. Set the calculation settings.

Go to (Mode — **Calculation Settings**, Calculation settings — **Static**, Static — **General**).

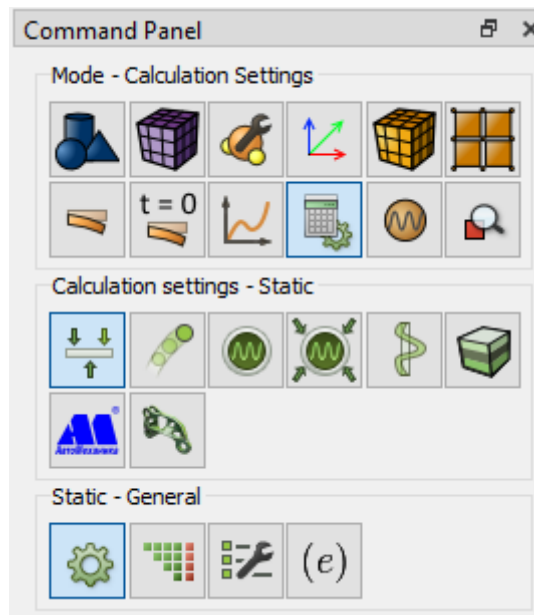

Set the following parameters:

- Dimensions: **3D**;
- Model: **Elasticity**.

Click **Apply**.

Extracting and Transforming of the Script

1. Extract the model script from **History**.

Go to the **Command line** and switch the tab to "**History**", where you will see the script of the model you generated:

```
reset  
brick x 20 y 0.5 z 10  
move Volume 1 x 0 y 0 z 30 include_merged  
create frustum height 25 radius 0.25 top 0.25  
move Volume 2 x 0 y 0 z 12.5 include_merged  
undo group begin  
imprint volume all  
merge volume all  
undo group end  
volume all scheme tetmesh  
mesh volume all  
create material 1 from 'Steel'  
set duplicate block elements off
```

```
block 1 add volume all
block 'Block 1' material 1 cs 1 element solid order 1
create displacement on surface 8 dof all fix
create distributed force on surface 3 force value 230 moment value 0 direction 0 1 0 specific
create gravity global
modify gravity 1 dof 3 value -9.81
analysis type static elasticity dim3
```

Right-click anywhere on the command line and select **Select All** , then right-click the selected script again and select **Copy** .

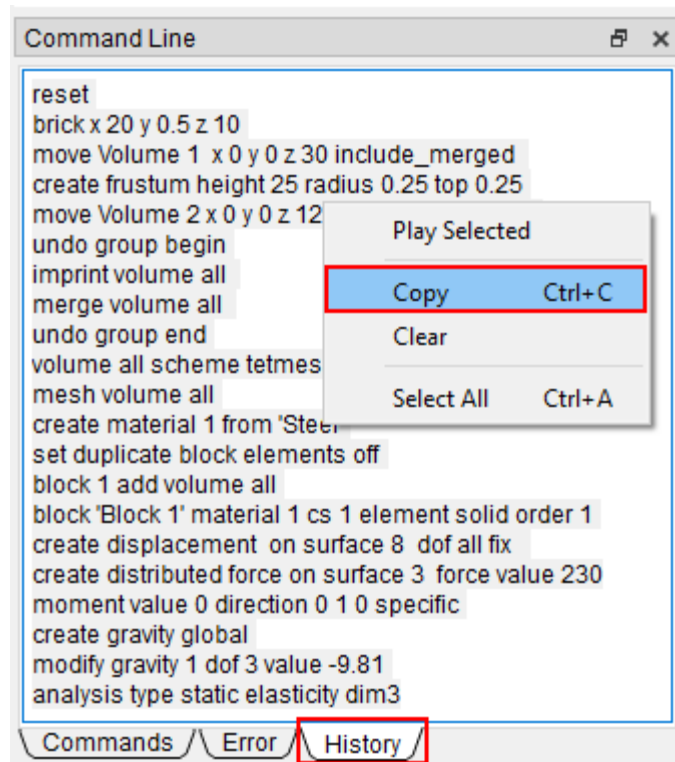

This is how you copied the script to the clipboard.

2. Convert the script to Python syntax.

Open the **Journal Editor** and paste the script you copied earlier into its window.

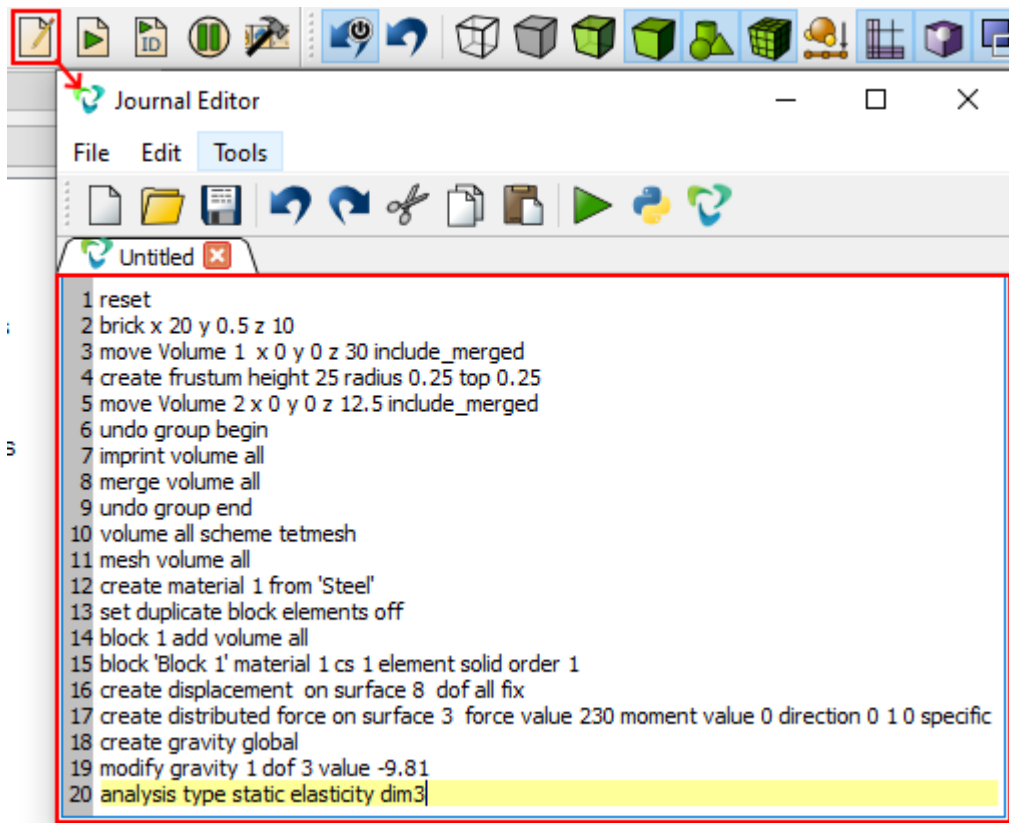

Convert the script to Python syntax via **Tools - Translate - Python**.

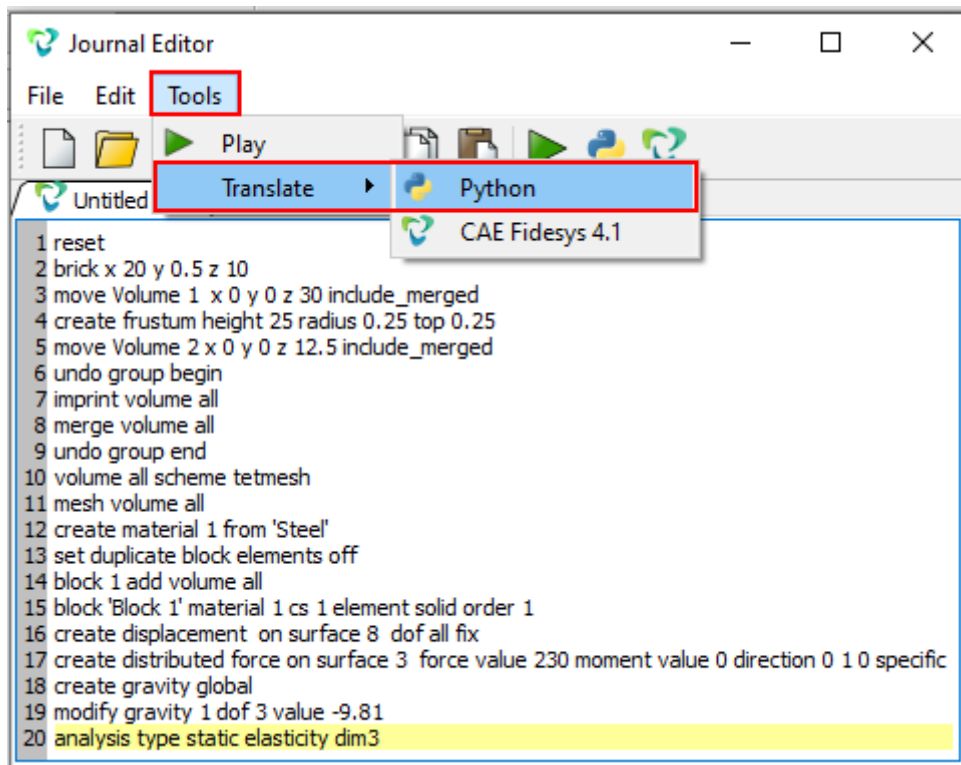

If everything is done correctly, then you will get the following script in the window:

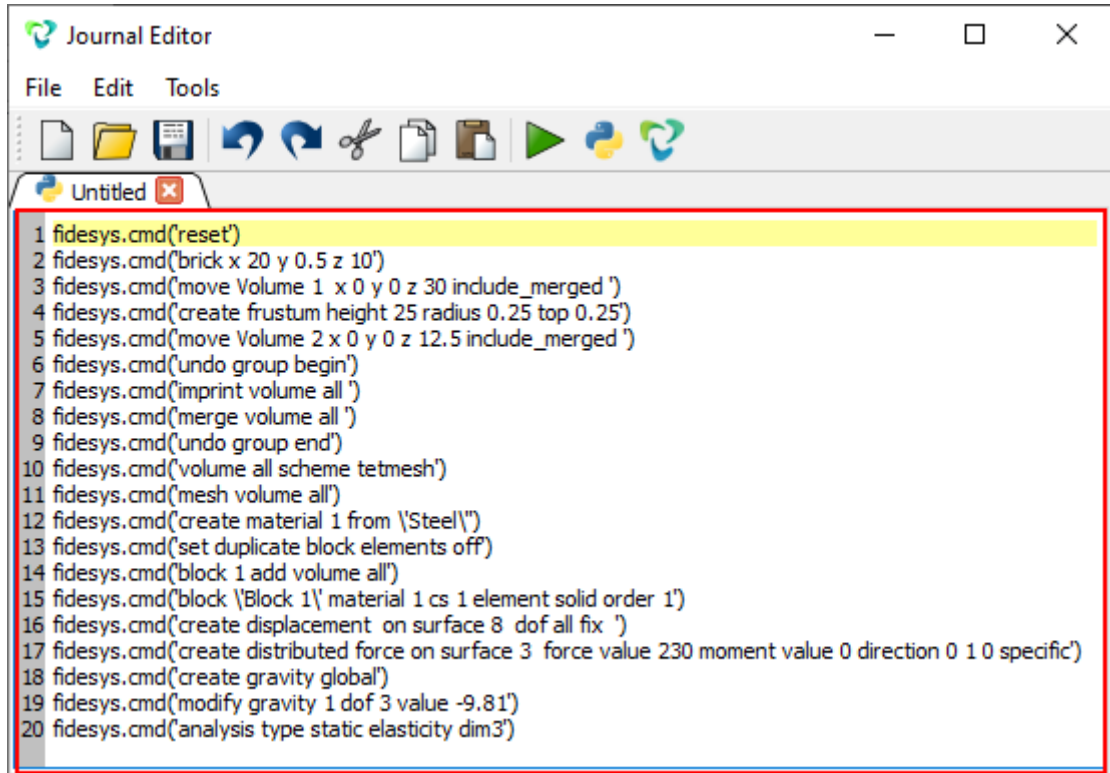

```
1 fidesys.cmd('reset')
2 fidesys.cmd('brick x 20 y 0.5 z 10')
3 fidesys.cmd('move Volume 1 x 0 y 0 z 30 include_merged ')
4 fidesys.cmd('create frustum height 25 radius 0.25 top 0.25')
5 fidesys.cmd('move Volume 2 x 0 y 0 z 12.5 include_merged ')
6 fidesys.cmd('undo group begin')
7 fidesys.cmd('imprint volume all ')
8 fidesys.cmd('merge volume all ')
9 fidesys.cmd('undo group end')
10 fidesys.cmd('volume all scheme tetmesh')
11 fidesys.cmd('mesh volume all')
12 fidesys.cmd('create material 1 from \'Steel\'')
13 fidesys.cmd('set duplicate block elements off')
14 fidesys.cmd('block 1 add volume all')
15 fidesys.cmd('block \'Block 1\' material 1 cs 1 element solid order 1')
16 fidesys.cmd('create displacement on surface 8 dof all fix ')
17 fidesys.cmd('create distributed force on surface 3 force value 230 moment value 0 direction 0 1 0 specific')
18 fidesys.cmd('create gravity global')
19 fidesys.cmd('modify gravity 1 dof 3 value -9.81')
20 fidesys.cmd('analysis type static elasticity dim3')
```

Copy the resulting Python script from the Journal Editor.

Create and run a Python script

1. Create a Python script file

Start **Python IDLE**, select **File - New File** from the menu, and a window for editing the script will open.

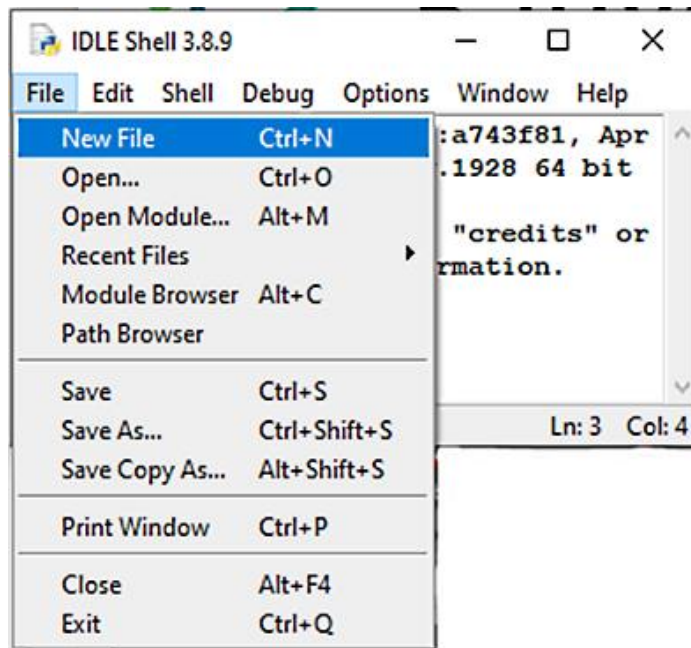

2. Copy and paste the script below into a blank window that opens

This Python script already contains the portion of the Fidesys model script that we got earlier. The place where the Fidesys model script is inserted is marked with appropriate comments.

Please **note** that the bottom diameter of the pillar is varied by modifying of the cone creating command:

- the initial view of the command: `fidesys.cmd("create frustum height 25 radius 0.25 top 0.25")`
- view of the changed command: `fidesys.cmd("create frustum height 25 radius "+str(r)+"top 0.25").`

Inserting `" +str(r)+"` adds a radius value to the text command break.

```
import vtk      # Library for working with output data
from vtk.util.numpy_support import vtk_to_numpy # Library for converting results
import sys     # System library
import os     # System library

fidesys_path = r'C:\Program Files\Fidesys\CAE-Fidesys-4.1' # Location of Fidesys
base_dir = os.path.dirname(os.path.abspath(__file__)) # Directory where the script is located
pvd_file = os.path.join(base_dir, '1.pvd') # Results Links File
prep_path = os.path.join(fidesys_path, 'preprocessor', 'bin') # Directory where the preprocessor is
os.environ['PATH'] += prep_path # Adding preprocessor path to PATH
sys.path.append(prepare_path) # Adding preprocessor path to PATH
import cubit    # Preprocessing library
import fidesys  # Library of Fidesys
cubit.init([""]) # Initializing the preprocessor
fc = fidesys.FidesysComponent() # Create a required Fidesys fc component
fc.initApplication(prepare_path) # Initializing the path to the preprocessor
fc.start_up_no_args() # Launch of the required Fidesys fc component
r = 0.25 # Initial bottom radius of the pillar
print("Initial bottom diameter: ", 2*r) # Output to the data console - the initial value of the diameter
isOptimized = False # Initially False - initial construction is not optimized
iteration = 1 # Initial value of the counter of passes (iterations)
```

```
while isOptimized == False: # The loop repeats until the condition isOptimized == True
    print("Iteration № ",iteration) # Write to the console which iteration
    overstressed = [] # Create an empty array to fill with overstressed nodes

    # -----Start script from Fidesys-----
    fidesys.cmd('reset')
    fidesys.cmd('brick x 20 y 0.5 z 10')
    fidesys.cmd('move Volume 1 x 0 y 0 z 30 include_merged ')
    fidesys.cmd("create frustum height 25 radius "+str(r)+"top 0.25")
    fidesys.cmd('move Volume 2 x 0 y 0 z 12.5 include_merged ')
    fidesys.cmd('undo group begin')
    fidesys.cmd('imprint volume all ')
    fidesys.cmd('merge volume all ')
    fidesys.cmd('undo group end')
    fidesys.cmd('volume all scheme tetmesh')
    fidesys.cmd('mesh volume all')
    fidesys.cmd('create material 1 from \'Steel\')
    fidesys.cmd('set duplicate block elements off')
    fidesys.cmd('block 1 add volume all')
    fidesys.cmd('block \'Block 1\' material 1 cs 1 element solid order 1')
    fidesys.cmd('create displacement on surface 8 dof all fix ')
    fidesys.cmd('create distributed force on surface 3 force value 230 moment value 0 direction 0 1 0 specific')
    fidesys.cmd('create gravity global')
    fidesys.cmd('modify gravity 1 dof 3 value -9.81')
    fidesys.cmd('analysis type static elasticity dim3')
    # -----End script from Fidesys-----

    output_pvd_path = os.path.join(base_dir + "\\ " + "1.pvd") # We declare the directory and the save file
    print("starting calculation to " + output_pvd_path) # We output the directory and the save file to the console
    fidesys.cmd("calculation start path " + output_pvd_path + "") # We ask Fidesys to start the calculation in the specified
    directory

    print(" ")
    print("Calculation completed successfully!")
    print(" ")
    reader = vtk.vtkXMLUnstructuredGridReader() # Connect the reader
    print("Reading the results from ",str(base_dir)+r"\\1\case1_step01_substep01.vtu") # Writes where we get the results
    from
    filename = os.path.join(str(base_dir)+r"\\1\case1_step01_substep01.vtu") # Specifying the path to the file
    reader.SetFileName(filename) # We connect the path to the reader and read
    reader.Update() # Needed because of GetScalarRange
    grid = reader.GetOutput() # We take the output
    point_data = grid.GetPointData() # We collect data for points
    arrayOfStress = vtk_to_numpy(point_data.GetArray("Stress")) # Reading stresses from the array of results
    node_id = vtk_to_numpy(point_data.GetArray("Node ID")) # Reading node numbers from the result array
    print("Start searching for overstressed nodes")
    print(" ")
    for point in range(len(arrayOfStress)):
        if arrayOfStress[point][6] > 106e6: # Checking the von Mises stresses in the nodes
            overstressed.append(node_id[point]) # Fill the array with numbers of overstressed nodes
    if len(overstressed) == 0: # The size of the array of overstressed nodes is checked, if it is 0 then
        isOptimized = True # set the variable isOptimized = True to exit the loop
    print("Design optimized!")
```

```
else:
    print("Overstressed nodes: ",len(overstressed)) # Displaying information about the number of overstressed nodes
    print(" ")
    r = r + 0.05 # Increase the radius by 0.05
    iteration = iteration + 1 # Increasing the value of the iteration counter
fc.deleteApplication() # Removing the completed task from memory
print(" ")
print("Complete! Optimal diameter is at least: ", 2*r)
```

3. Run the script.

Select **Run - Run Module** from the menu and when the system asks to save this file, save it to the "**Example**" folder created in a directory with no Cyrillic characters in its path to avoid errors.

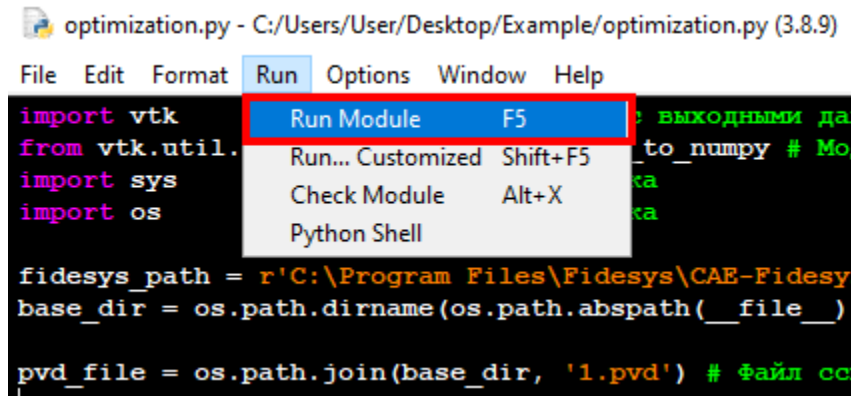

The following messages will appear in the console.

```
Python 3.8.10 (tags/v3.8.10:3d8993a, May 3 2021, 11:48:03) [MSC v.1928 64 bit (AMD64)]
on win32
Type "help", "copyright", "credits" or "license()" for more information.
>>>
===== RESTART: C:/Users/User/Desktop/New folder/1.py =====
Initial bottom diameter: 0.5
Iteration № 1
starting calculation to C:\Users\User\Desktop\New folder\1.pvd

Calculation completed successfully!

Reading the results from C:\Users\User\Desktop\New folder\1\case1_step01_substep01.vtu
Start searching for overstressed nodes

Overstressed nodes: 2931

Iteration № 2
starting calculation to C:\Users\User\Desktop\New folder\1.pvd

Calculation completed successfully!

Reading the results from C:\Users\User\Desktop\New folder\1\case1_step01_substep01.vtu
Start searching for overstressed nodes

Design optimized!

Complete! Optimal diameter is at least: 0.6
>>> |
```

Ln: 27 Col: 4

The results will be saved to the folder where the script file was located. Upon completion of the calculation, you can open and view the 1.pvd results file.

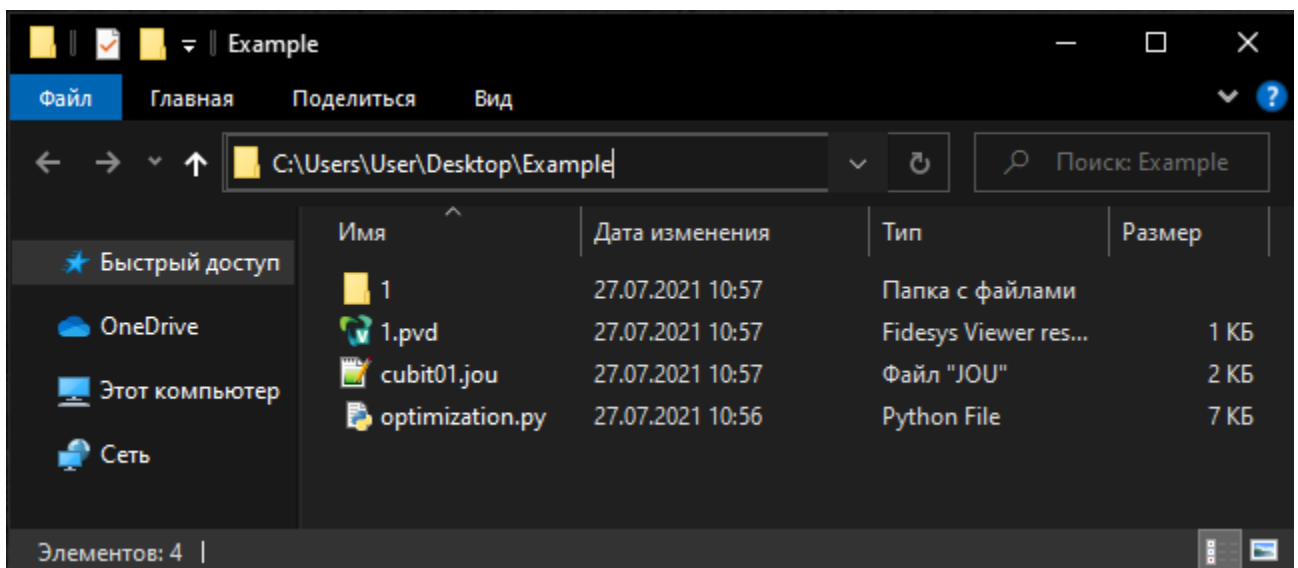



Contacts

<http://www.cae-fidesys.com>

support@cae-fidesys.com

[+7 \(495\) 177-36-18](tel:+74951773618)